

Capacitor, Film, Metallized Polypropylene, 0.1 uF, +/-5% Tol, -40/+85C, Power, 700 VAC

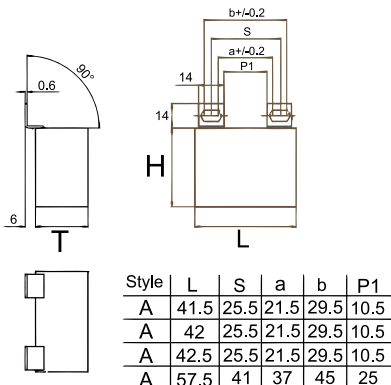

Dimensions (mm)		
Symbol	Dimension	Tolerance
L	41.5	NOM
H	40	NOM
T	20	NOM
S	25	+/-0.2

Packaging Specifications	
Package Kind:	Bulk
Package Quantity:	52

General Information	
Supplier:	KEMET
Dielectric:	Metallized Polypropylene
Application:	Power
Style:	Radial Box
Features:	IGBT Circuit
RoHS:	Yes

Specifications	
Capacitance:	0.1 uF
Voltage:	2000 V
Tolerance:	+/-5%
Voltage AC:	700 VAC
Rated Temperature:	70C
Temperature Range:	-40/+85C
Maximum dVdT:	1379 v/us
Current/Ripple Current:	10 Amps (100kHz 70C)
Current/Ripple Current:	138 Amps (Peak)
Resistance/ESR:	23.3 mOhms (100kHz)
Inductance:	41 nH
Miscellaneous:	Kemet Style A Tabs