



RF Power Field Effect Transistor

N-Channel Enhancement-Mode Lateral MOSFET

Designed for pulsed wideband applications operating at frequencies between 3100 and 3500 MHz.

- Typical Pulsed Performance: $V_{DD} = 32$ Volts, $I_{DQ} = 150$ mA,
 $P_{out} = 120$ Watts Peak (24 Watts Avg.), Pulsed Signal, $f = 3500$ MHz,
Pulse Width = 100 μ sec, Duty Cycle = 20%
Power Gain — 12 dB
Drain Efficiency — 40%
Rise Time — 6 ns
Fall Time — 6 ns
- Typical WiMAX Performance: $V_{DD} = 32$ Volts, $I_{DQ} = 900$ mA,
 $P_{out} = 18$ Watts Avg., $f = 3500$ MHz, 802.16d, 64 QAM $3/4$, 4 Bursts,
7 MHz Channel Bandwidth, Input Signal PAR = 9.5 dB @ 0.01%
Probability on CCDF
Power Gain — 13 dB
Drain Efficiency — 16%
RCE — -33 dB (EVM — 2.2% rms)
- Capable of Handling 10:1 VSWR, @ 32 Vdc, 3300 MHz, 120 Watts Peak Power
- Capable of Handling 3 dB Overdrive @ 32 Vdc

Features

- Characterized with Series Equivalent Large-Signal Impedance Parameters
- Internally Matched for Ease of Use
- Qualified Up to a Maximum of 32 V_{DD} Operation
- Integrated ESD Protection
- Greater Negative Gate-Source Voltage Range for Improved Class C Operation
- RoHS Compliant
- In Tape and Reel. R3 Suffix = 250 Units per 56 mm, 13 inch Reel.

MRF7S35120HSR3

**3100-3500 MHz, 120 W PEAK, 32 V
PULSED
LATERAL N-CHANNEL
RF POWER MOSFET**

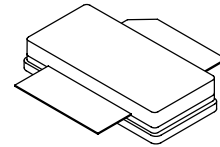

**CASE 465A-06, STYLE 1
NI-780S**

Table 1. Maximum Ratings

Rating	Symbol	Value	Unit
Drain-Source Voltage	V_{DSS}	-0.5, +65	Vdc
Gate-Source Voltage	V_{GS}	-6.0, +10	Vdc
Storage Temperature Range	T_{stg}	- 65 to +150	$^{\circ}$ C
Case Operating Temperature	T_C	150	$^{\circ}$ C
Operating Junction Temperature (1,2)	T_J	225	$^{\circ}$ C

Table 2. Thermal Characteristics

Characteristic	Symbol	Value (2,3)	Unit
Thermal Resistance, Junction to Case Case Temperature 79 $^{\circ}$ C, 120 W Pulsed, 100 μ sec Pulse Width, 20% Duty Cycle Case Temperature 72 $^{\circ}$ C, 120 W Pulsed, 500 μ sec Pulse Width, 10% Duty Cycle	$Z_{\theta JC}$	0.11 0.12	$^{\circ}$ C/W

1. Continuous use at maximum temperature will affect MTTF.
2. MTTF calculator available at <http://www.freescale.com/rf>. Select Software & Tools/Development Tools/Calculators to access MTTF calculators by product.
3. Refer to AN1955, *Thermal Measurement Methodology of RF Power Amplifiers*. Go to <http://www.freescale.com/rf>. Select Documentation/Application Notes - AN1955.

Table 3. ESD Protection Characteristics

Test Methodology	Class
Human Body Model (per JESD22-A114)	1C (Minimum)
Machine Model (per EIA/JESD22-A115)	A (Minimum)
Charge Device Model (per JESD22-C101)	IV (Minimum)

Table 4. Electrical Characteristics ($T_C = 25^\circ\text{C}$ unless otherwise noted)

Characteristic	Symbol	Min	Typ	Max	Unit
----------------	--------	-----	-----	-----	------

Off Characteristics

Gate-Source Leakage Current ($V_{GS} = 5\text{ Vdc}$, $V_{DS} = 0\text{ Vdc}$)	I_{GSS}	—	—	1	μAdc
Zero Gate Voltage Drain Leakage Current ($V_{DS} = 32\text{ Vdc}$, $V_{GS} = 0\text{ Vdc}$)	I_{DSS}	—	—	1	μAdc
Zero Gate Voltage Drain Leakage Current ($V_{DS} = 65\text{ Vdc}$, $V_{GS} = 0\text{ Vdc}$)	I_{DSS}	—	—	10	μAdc

On Characteristics

Gate Threshold Voltage ($V_{DS} = 10\text{ Vdc}$, $I_D = 400\ \mu\text{Adc}$)	$V_{GS(th)}$	1.2	1.9	2.7	Vdc
Gate Quiescent Voltage ($V_{DD} = 32\text{ Vdc}$, $I_D = 150\text{ mAdc}$, Measured in Functional Test)	$V_{GS(Q)}$	1.5	2.4	3	Vdc
Drain-Source On-Voltage ($V_{GS} = 10\text{ Vdc}$, $I_D = 2.0\text{ Adc}$)	$V_{DS(on)}$	0.1	0.17	0.3	Vdc

Dynamic Characteristics ⁽¹⁾

Reverse Transfer Capacitance ($V_{DS} = 32\text{ Vdc} \pm 30\text{ mV(rms)ac}$ @ 1 MHz, $V_{GS} = 0\text{ Vdc}$)	C_{rss}	—	0.87	—	pF
Output Capacitance ($V_{DS} = 32\text{ Vdc} \pm 30\text{ mV(rms)ac}$ @ 1 MHz, $V_{GS} = 0\text{ Vdc}$)	C_{oss}	—	464	—	pF
Input Capacitance ($V_{DS} = 32\text{ Vdc}$, $V_{GS} = 0\text{ Vdc} \pm 30\text{ mV(rms)ac}$ @ 1 MHz)	C_{iss}	—	214	—	pF

Functional Tests (In Freescale Test Fixture, 50 ohm system) $V_{DD} = 32\text{ Vdc}$, $I_{DQ} = 150\text{ mA}$, $P_{out} = 120\text{ W Peak}$ (24 W Avg.), $f = 3100\text{ MHz}$ and $f = 3500\text{ MHz}$, Pulsed, 100 μsec Pulse Width, 20% Duty Cycle, <25 ns Input Rise Time

Power Gain	G_{ps}	10.5	12	13.5	dB
Drain Efficiency	η_D	38	40	—	%
Input Return Loss	IRL	—	-15	-8	dB

Pulsed RF Performance (In Freescale Application Test Fixture, 50 ohm system) $V_{DD} = 32\text{ Vdc}$, $I_{DQ} = 150\text{ mA}$, $P_{out} = 120\text{ W Peak}$ (24 W Avg.), $f = 3100\text{ MHz}$ and $f = 3500\text{ MHz}$, Pulsed, 100 μsec Pulse Width, 20% Duty Cycle, <25 ns Input Rise Time

Output Pulse Droop (500 μsec Pulse Width, 10% Duty Cycle)	DRP_{out}	—	0.3	—	dB
Load Mismatch Tolerance (VSWR = 10:1 at all Phase Angles)	VSWR-T	No Degradation in Output Power			

1. Part internally matched both on input and output.

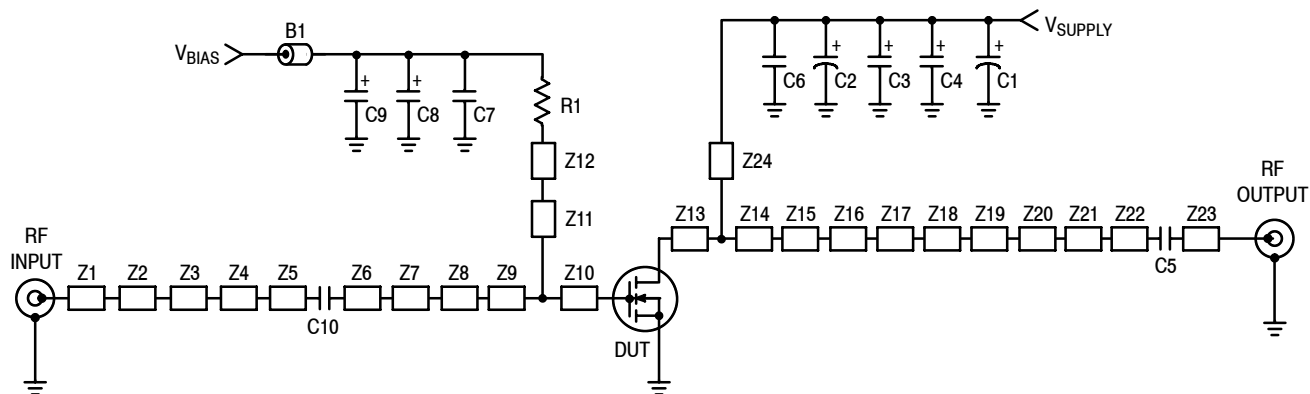

Z1	0.120" x 0.082" Microstrip	Z14	0.390" x 0.576" Microstrip
Z2*	0.094" x 0.310" Microstrip	Z15	0.202" x 0.082" Microstrip
Z3*	0.3502" x 0.082" Microstrip	Z16	0.066" x 0.162" Microstrip
Z4	0.120" x 0.629" Microstrip	Z17	0.084" x 0.330" Microstrip
Z5, Z22	0.050" x 0.082" Microstrip	Z18	0.105" x 0.082" Microstrip
Z6	0.052" x 0.082" Microstrip	Z19	0.080" x 0.147" Microstrip
Z7	0.084" x 0.436" Microstrip	Z20	0.366" x 0.082" Microstrip
Z8	1.142" x 0.082" Microstrip	Z21	0.070" x 0.207" Microstrip
Z9	0.144" x 0.564" Microstrip	Z23	0.734" x 0.082" Microstrip
Z10	0.078" x 0.564" Microstrip	Z24	0.071" x 0.477" Microstrip
Z11	0.048" x 1.349" Microstrip	PCB	Arlon CuClad 250GX-0300-55-22, 0.030", $\epsilon_r = 2.55$
Z12	0.120" x 0.175" Microstrip		
Z13	0.087" x 0.576" Microstrip		

* Line length includes microstrip bends

Figure 1. MRF7S35120HSR3 Test Circuit Schematic

Table 5. MRF7S35120HSR3 Test Circuit Component Designations and Values

Part	Description	Part Number	Manufacturer
B1	47 Ω , 100 MHz Short Ferrite Bead	2743019447	Fair-Rite
C1	470 μ F, 63 V Electrolytic Capacitor	477KXM063M	Illinois Capacitor
C2	47 μ F, 50 V Electrolytic Capacitor	476KXM050M	Illinois Capacitor
C3, C4	22 μ F, 35 V Tantalum Capacitors	T491X226K035AT	Kemet
C5	3.3 pF Chip Capacitor	ATC100B3R3CT500XT	ATC
C6, C7, C10	2.7 pF Chip Capacitors	ATC100B2R7BT500XT	ATC
C8, C9	22 μ F, 25 V Tantalum Capacitors	ECS-T1ED226R	Panasonic TE series
J1	Jumper	Copper Foil	
R1	51 Ω , 1/4 W Chip Resistor	CRCW120651R0FKEA	Vishay

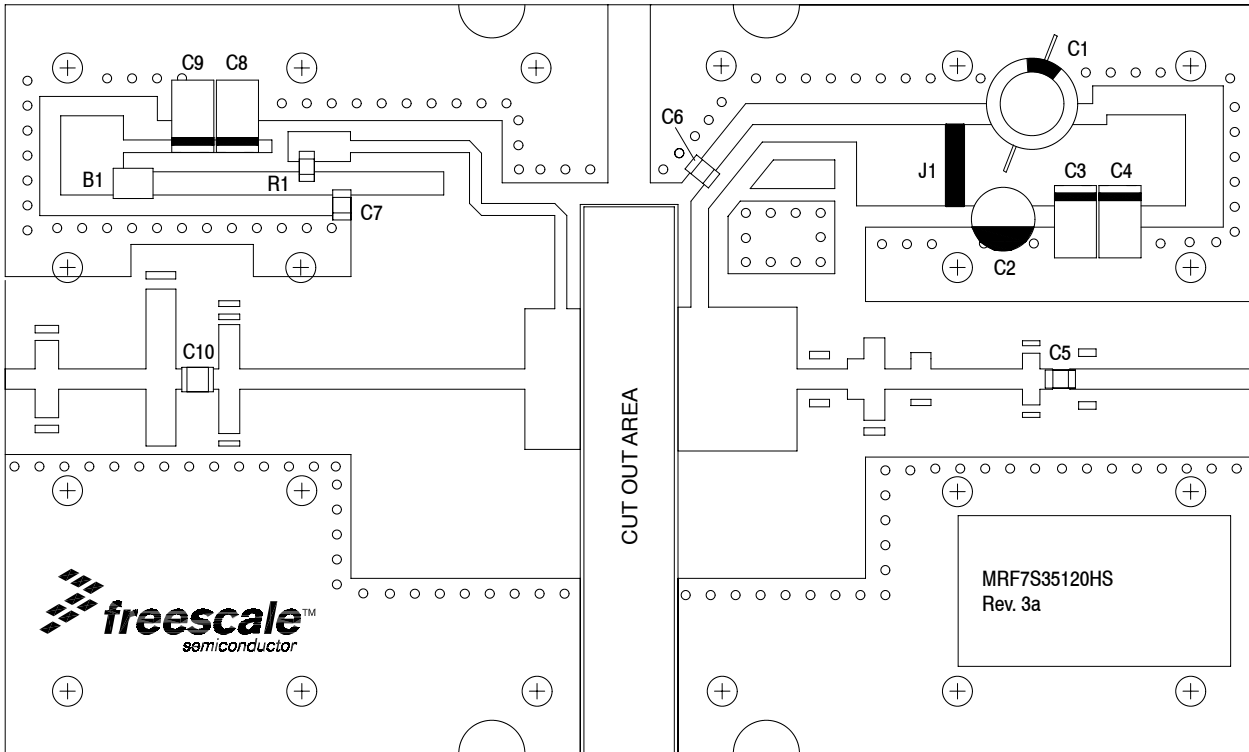

Figure 2. MRF7S35120HSR3 Test Circuit Component Layout

TYPICAL CHARACTERISTICS

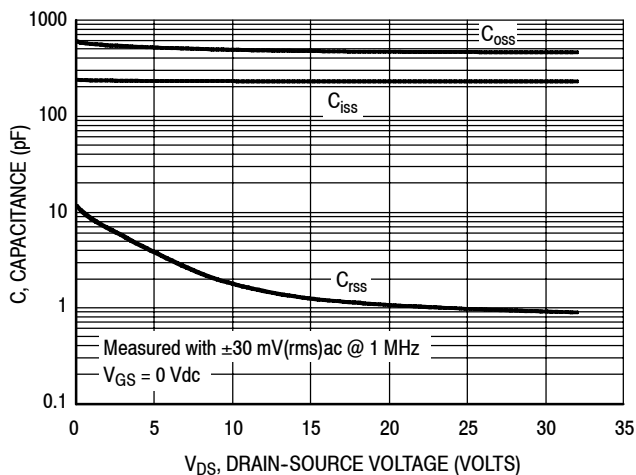

Figure 3. Capacitance versus Drain-Source Voltage

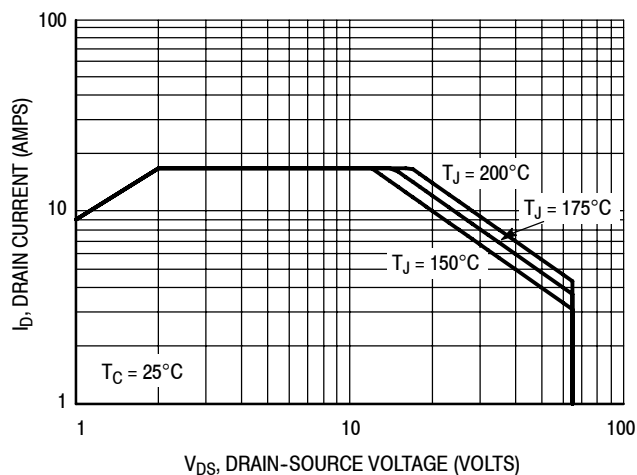

Figure 4. DC Safe Operating Area

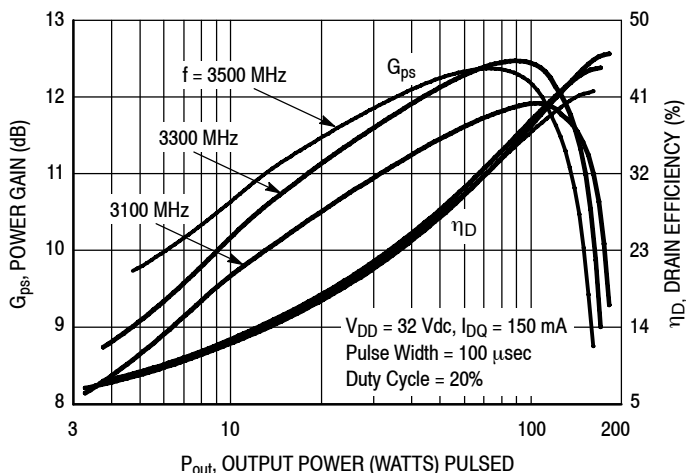

Figure 5. Pulsed Power Gain and Drain Efficiency versus Output Power

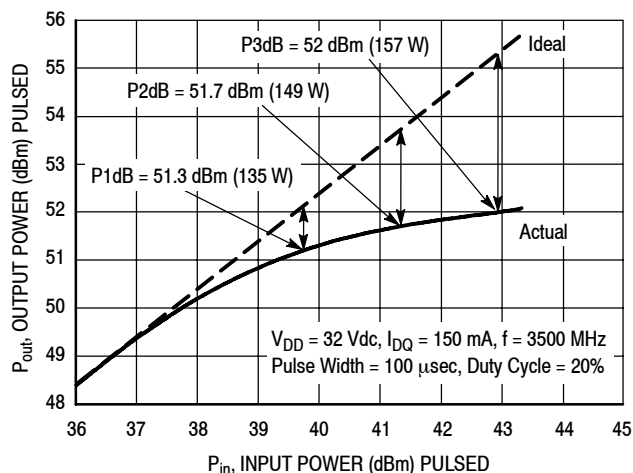

Figure 6. Pulsed Output Power versus Input Power

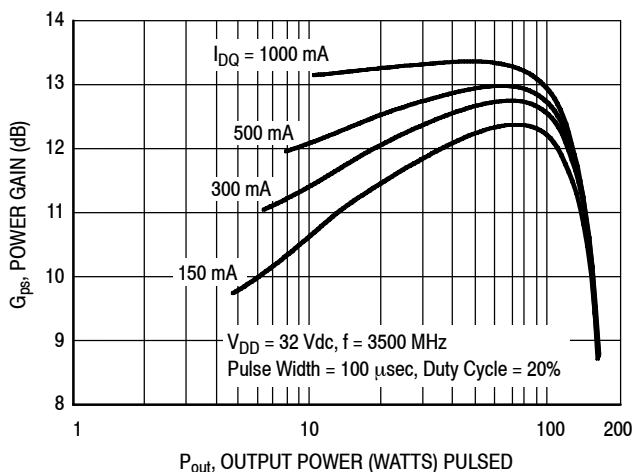

Figure 7. Pulsed Power Gain versus Output Power

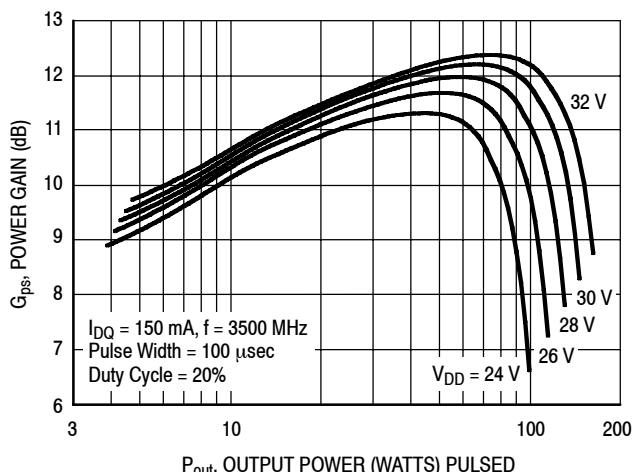

Figure 8. Pulsed Power Gain versus Output Power

TYPICAL CHARACTERISTICS

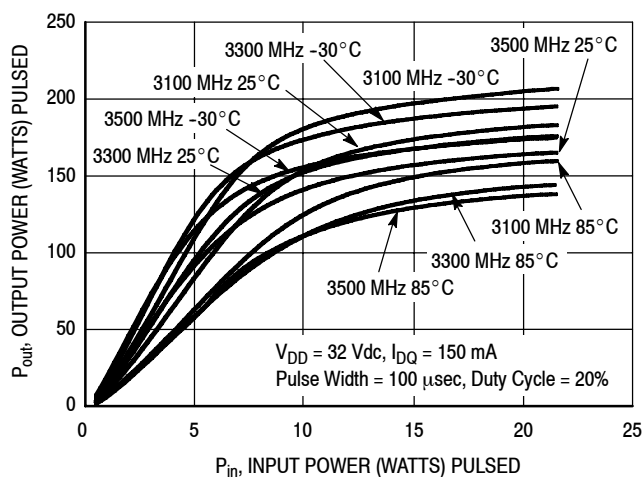

Figure 9. Pulsed Output Power versus Input Power

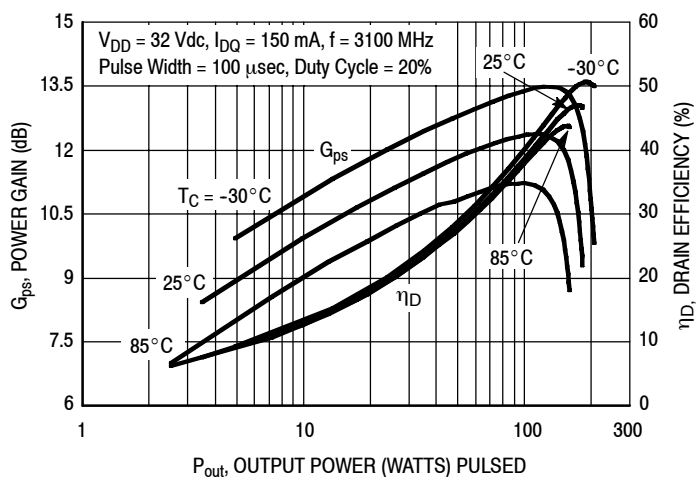

Figure 10. Pulsed Power Gain and Drain Efficiency versus Output Power — 3100 MHz

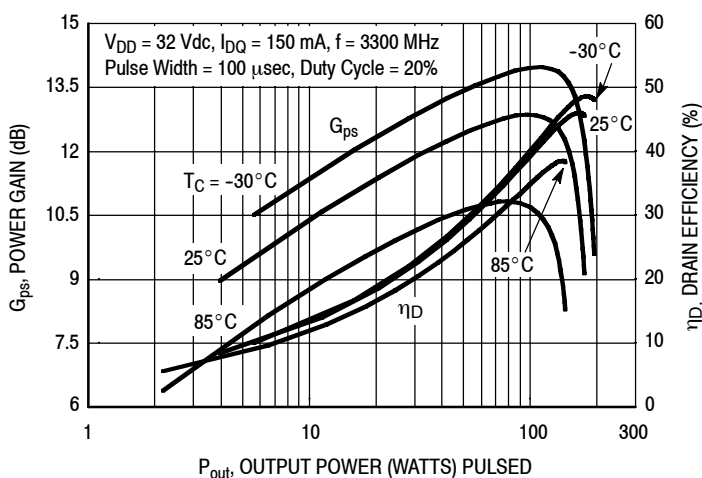

Figure 11. Pulsed Power Gain and Drain Efficiency versus Output Power — 3300 MHz

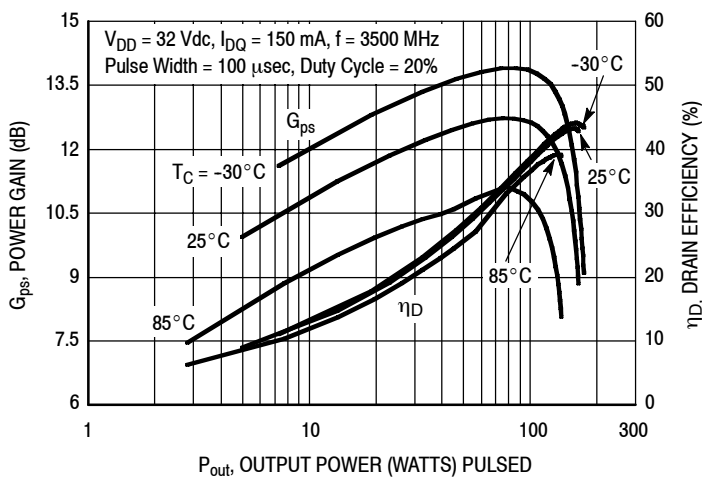

Figure 12. Pulsed Power Gain and Drain Efficiency versus Output Power — 3500 MHz

TYPICAL CHARACTERISTICS

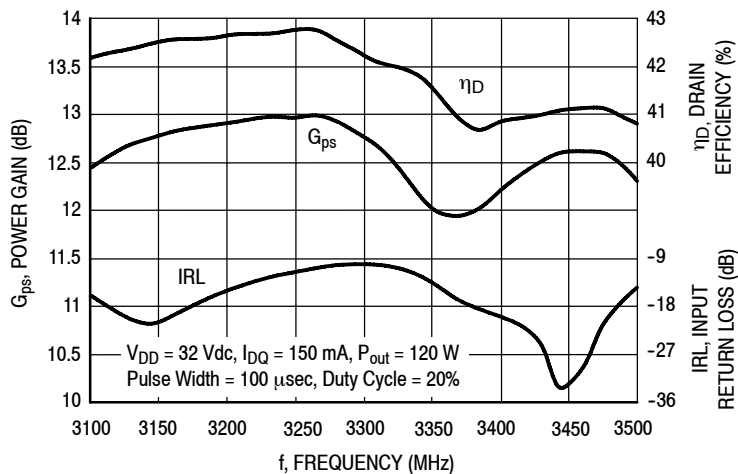

Figure 13. Pulsed Power Gain, Drain Efficiency and IRL versus Frequency

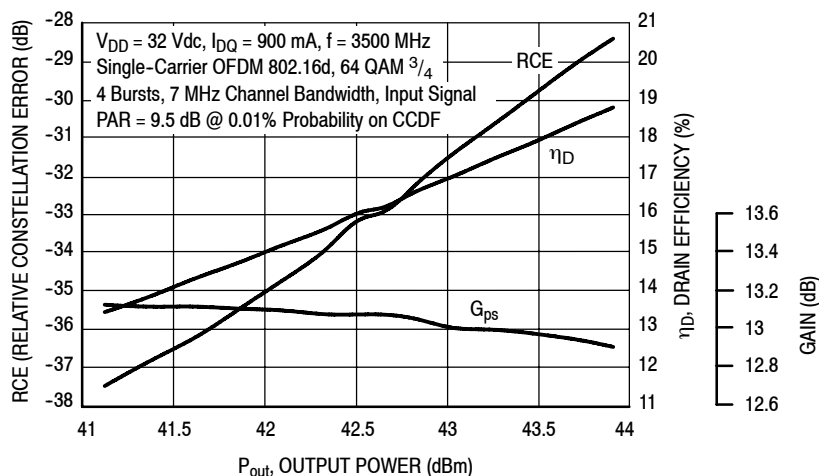
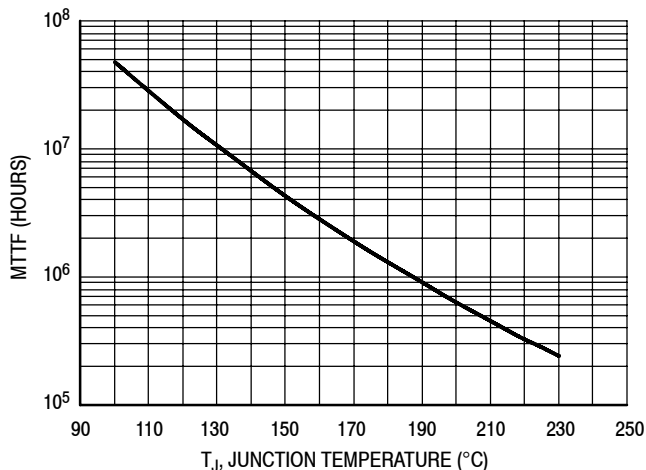

Figure 14. Single-Channel OFDM Relative Constellation Error, Drain Efficiency and Gain versus Output Power



This above graph displays calculated MTTF in hours when the device is operated at $V_{DD} = 32$ Vdc, $P_{out} = 120$ W Peak, Pulse Width = 100 μ sec, Duty Cycle = 20%, and $\eta_D = 40\%$.

MTTF calculator available at <http://www.freescale.com/rf>. Select Software & Tools/Development Tools/Calculators to access MTTF calculators by product.

Figure 15. MTTF versus Junction Temperature

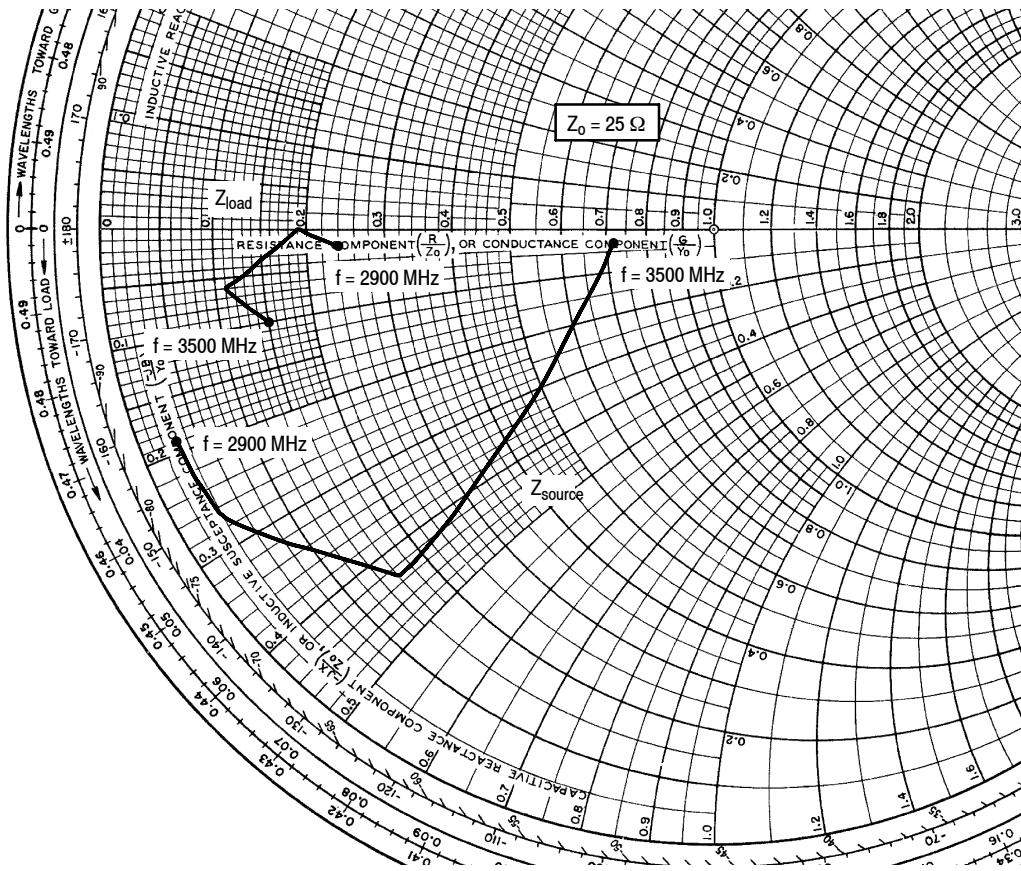

$V_{DD} = 32 \text{ Vdc}$, $I_{DQ} = 150 \text{ mA}$, $P_{out} = 120 \text{ W Peak}$

f MHz	Z_{source} Ω	Z_{load} Ω
2900	$0.825 - j4.72$	$6.03 - j0.487$
3100	$1.1 - j6.74$	$4.63 - j0.0472$
3300	$3.95 - j10.8$	$2.65 - j1.44$
3500	$18 - j1.1$	$3.65 - j2.56$

Z_{source} = Test circuit impedance as measured from gate to ground.

Z_{load} = Test circuit impedance as measured from drain to ground.

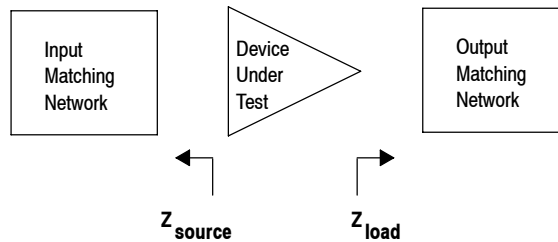
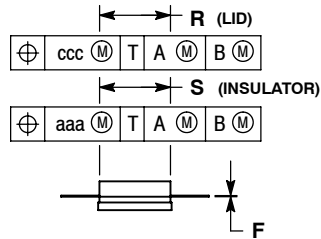
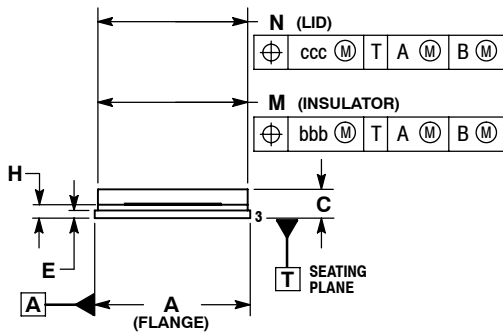
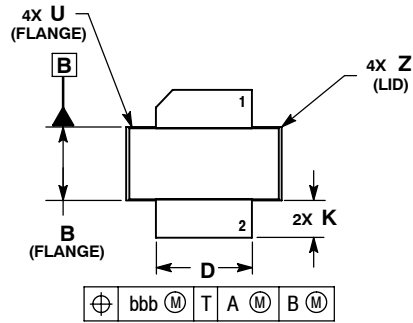

Figure 16. Series Equivalent Source and Load Impedance

PACKAGE DIMENSIONS



- NOTES:
1. DIMENSIONING AND TOLERANCING PER ANSI Y14.5M-1994.
 2. CONTROLLING DIMENSION: INCH.
 3. DELETED
 4. DIMENSION H IS MEASURED 0.030 (0.762) AWAY FROM PACKAGE BODY.

DIM	INCHES		MILLIMETERS	
	MIN	MAX	MIN	MAX
A	0.805	0.815	20.45	20.70
B	0.380	0.390	9.65	9.91
C	0.125	0.170	3.18	4.32
D	0.495	0.505	12.57	12.83
E	0.035	0.045	0.89	1.14
F	0.003	0.006	0.08	0.15
H	0.057	0.067	1.45	1.70
K	0.170	0.210	4.32	5.33
M	0.774	0.786	19.61	20.02
N	0.772	0.788	19.61	20.02
R	0.365	0.375	9.27	9.53
S	0.365	0.375	9.27	9.52
U	---	0.040	---	1.02
Z	---	0.030	---	0.76
aaa	0.005 REF		0.127 REF	
bbb	0.010 REF		0.254 REF	
ccc	0.015 REF		0.381 REF	

- STYLE 1:
 PIN 1. DRAIN
 2. GATE
 5. SOURCE

**CASE 465A-06
 ISSUE H
 NI-780S**

PRODUCT DOCUMENTATION

Refer to the following documents to aid your design process.

Application Notes

- AN1955: Thermal Measurement Methodology of RF Power Amplifiers

Engineering Bulletins

- EB212: Using Data Sheet Impedances for RF LDMOS Devices

REVISION HISTORY

The following table summarizes revisions to this document.

Revision	Date	Description
0	May 2008	<ul style="list-style-type: none">• Initial Release of Data Sheet
1	June 2008	<ul style="list-style-type: none">• Corrected P_{out} error and changed from 42.5 Watts to 18 Watts, Typical WiMAX Performance bullet, p. 1
2	Nov. 2008	<ul style="list-style-type: none">• Updated Fig. 15, MTF versus Junction Temperature, to correct a calculation error, p. 7
3	June 2010	<ul style="list-style-type: none">• Added Rise and Fall Time data to Typical Pulsed Performance bullet, p. 1• Reporting of pulsed thermal data now shown using the $Z_{\theta JC}$ symbol, Table 2, Thermal Characteristics, p. 1• Added less than sign (<) to 25 ns in Functional Tests table header and Pulsed RF Performance table header, p. 2• Added Jumper to Table 6, Test Circuit Component Designations and Values and to Fig. 2, Test Circuit Component Layout, p. 3, 4

How to Reach Us:

Home Page:

www.freescale.com

Web Support:

<http://www.freescale.com/support>

USA/Europe or Locations Not Listed:

Freescale Semiconductor, Inc.
Technical Information Center, EL516
2100 East Elliot Road
Tempe, Arizona 85284
1-800-521-6274 or +1-480-768-2130
www.freescale.com/support

Europe, Middle East, and Africa:

Freescale Halbleiter Deutschland GmbH
Technical Information Center
Schatzbogen 7
81829 Muenchen, Germany
+44 1296 380 456 (English)
+46 8 52200080 (English)
+49 89 92103 559 (German)
+33 1 69 35 48 48 (French)
www.freescale.com/support

Japan:

Freescale Semiconductor Japan Ltd.
Headquarters
ARCO Tower 15F
1-8-1, Shimo-Meguro, Meguro-ku,
Tokyo 153-0064
Japan
0120 191014 or +81 3 5437 9125
support.japan@freescale.com

Asia/Pacific:

Freescale Semiconductor China Ltd.
Exchange Building 23F
No. 118 Jianguo Road
Chaoyang District
Beijing 100022
China
+86 10 5879 8000
support.asia@freescale.com

For Literature Requests Only:

Freescale Semiconductor Literature Distribution Center
1-800-441-2447 or +1-303-675-2140
Fax: +1-303-675-2150
LDCForFreescaleSemiconductor@hibbertgroup.com

Information in this document is provided solely to enable system and software implementers to use Freescale Semiconductor products. There are no express or implied copyright licenses granted hereunder to design or fabricate any integrated circuits or integrated circuits based on the information in this document.

Freescale Semiconductor reserves the right to make changes without further notice to any products herein. Freescale Semiconductor makes no warranty, representation or guarantee regarding the suitability of its products for any particular purpose, nor does Freescale Semiconductor assume any liability arising out of the application or use of any product or circuit, and specifically disclaims any and all liability, including without limitation consequential or incidental damages. "Typical" parameters that may be provided in Freescale Semiconductor data sheets and/or specifications can and do vary in different applications and actual performance may vary over time. All operating parameters, including "Typicals", must be validated for each customer application by customer's technical experts. Freescale Semiconductor does not convey any license under its patent rights nor the rights of others. Freescale Semiconductor products are not designed, intended, or authorized for use as components in systems intended for surgical implant into the body, or other applications intended to support or sustain life, or for any other application in which the failure of the Freescale Semiconductor product could create a situation where personal injury or death may occur. Should Buyer purchase or use Freescale Semiconductor products for any such unintended or unauthorized application, Buyer shall indemnify and hold Freescale Semiconductor and its officers, employees, subsidiaries, affiliates, and distributors harmless against all claims, costs, damages, and expenses, and reasonable attorney fees arising out of, directly or indirectly, any claim of personal injury or death associated with such unintended or unauthorized use, even if such claim alleges that Freescale Semiconductor was negligent regarding the design or manufacture of the part.

Freescale™ and the Freescale logo are trademarks of Freescale Semiconductor, Inc. All other product or service names are the property of their respective owners.

© Freescale Semiconductor, Inc. 2008, 2010. All rights reserved.

