

FEATURES

- Accurate monitoring of up to four power supply voltages
- 2 factory-set threshold options for monitoring 1.8 V and 3.3 V
- Adjustable input threshold voltage 0.62 V ($\pm 1.5\%$ accuracy)
- 50 ms typical reset timeout
- Open-drain RESET output (10 μ A internal pull-up)
- Reset output stage: active low, valid to $IN_1 = 1$ V or $IN_2 = 1$ V
- Power supply glitch immunity
- Specified from -40°C to $+85^\circ\text{C}$
- 6-lead SOT-23 package

APPLICATIONS

- Telecommunications
- Microprocessor systems
- Desktop and notebook computers
- Data storage equipment
- Servers/workstations

GENERAL DESCRIPTION

The [ADM8710](#) is a low voltage, high accuracy supervisory circuit. The device monitors up to four system supply voltages.

The [ADM8710](#) incorporates two internally pretrimmed under-voltage threshold options for monitoring 1.8 V and 3.3 V supply voltages. It also offers two adjustable inputs with 0.62 V internal reference, allowing users to program the reset threshold through external resistor dividers. The combination of pretrimmed and adjustable inputs gives the [ADM8710](#) the advantage of being both space saving and flexible.

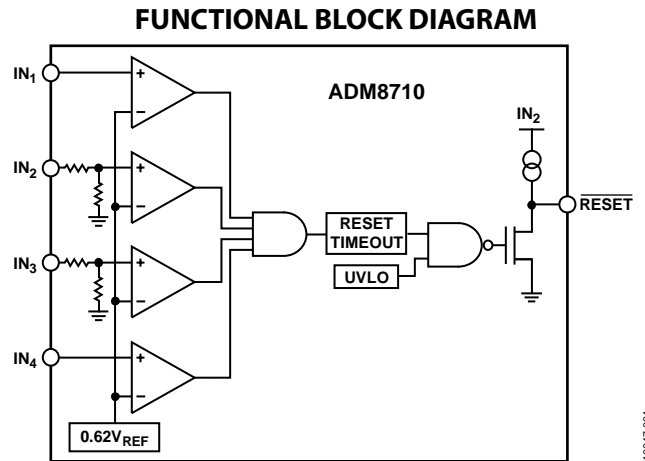

Figure 1.

10647-001

If a monitored power supply voltage falls below the minimum voltage threshold, a single active low output asserts, triggering a system reset. The output is open drain with a weak internal pull-up to the monitored IN_2 supply of typically 10 μ A. When all voltages rise above the selected threshold level, the RESET signal remains low for the reset timeout period. The [ADM8710](#) output remains valid as long as IN_1 or IN_2 exceeds 1 V.

Unused monitored inputs should not be allowed to float or to be grounded. Instead, connect them to a supply voltage greater than their specified threshold voltages.

The [ADM8710](#) is available in a 6-lead SOT-23 package. The device operates over the extended temperature range of -40°C to $+85^\circ\text{C}$.

Rev. 0

Information furnished by Analog Devices is believed to be accurate and reliable. However, no responsibility is assumed by Analog Devices for its use, nor for any infringements of patents or other rights of third parties that may result from its use. Specifications subject to change without notice. No license is granted by implication or otherwise under any patent or patent rights of Analog Devices. Trademarks and registered trademarks are the property of their respective owners.

ADM8710* PRODUCT PAGE QUICK LINKS

Last Content Update: 02/23/2017

COMPARABLE PARTS

View a parametric search of comparable parts.

DOCUMENTATION

Data Sheet

- ADM8710: Low Voltage, High Accuracy, Quad Voltage Microprocessor Supervisory Circuit Data Sheet

DESIGN RESOURCES

- ADM8710 Material Declaration
- PCN-PDN Information
- Quality And Reliability
- Symbols and Footprints

DISCUSSIONS

View all ADM8710 EngineerZone Discussions.

SAMPLE AND BUY

Visit the product page to see pricing options.

TECHNICAL SUPPORT

Submit a technical question or find your regional support number.

DOCUMENT FEEDBACK

Submit feedback for this data sheet.

TABLE OF CONTENTS

Features	1	Theory of Operation	8
Applications.....	1	Input Configuration.....	8
Functional Block Diagram	1	RESET Output Configuration	8
General Description	1	Addition of Manual Reset	8
Revision History	2	Tolerance and Accuracy	9
Specifications.....	3	Model Options	10
Absolute Maximum Ratings.....	4	Outline Dimensions	11
ESD Caution.....	4	Ordering Guide	11
Pin Configuration and Function Descriptions.....	5		
Typical Performance Characteristics	6		

REVISION HISTORY

8/12—Revision 0: Initial Version

SPECIFICATIONS

$V_{IN2} = 1\text{ V to }5.5\text{ V}$, $T_A = -40^\circ\text{C to }+85^\circ\text{C}$, unless otherwise noted. Typical values are $V_{IN2} = 3.0\text{ V to }3.3\text{ V}$, $T_A = 25^\circ\text{C}$.

Table 1.

Parameter	Min	Typ	Max	Units	Test Conditions/Comments
OPERATING VOLTAGE RANGE					
V_{IN2} ¹	1.0		5.5	V	$T_A = 0^\circ\text{C to }85^\circ\text{C}$
	1.2		5.5	V	$T_A = -40^\circ\text{C to }+85^\circ\text{C}$
INPUT CURRENT					
IN_x Input Current		55	115	μA	$IN_2 =$ nominal input voltage (3.3 V supplies); the supply splits into 25 μA for the resistor divider and 30 μA for other circuits
		25	40	μA	$IN_3 =$ nominal input voltage (1.8 V supplies)
			0.4	μA	$V_{IN1} = 0\text{ V to }0.85\text{ V}$
			0.2	μA	$V_{IN4} = 0\text{ V to }0.85\text{ V}$
THRESHOLD VOLTAGE					
Threshold Voltage (V_{TH})	3.010	3.07	3.130	V	IN_x decreasing; 3.3 V (–5% supply tolerance)
	1.705	1.73	1.760	V	IN_x decreasing; 1.8 V (–2% supply tolerance)
Adjustable Input Threshold Voltage (V_{TH})	0.611	0.62	0.629	V	IN_x decreasing
RESET					
Reset Threshold Hysteresis (V_{HYST})		0.3		$\%V_{TH}$	IN_x increasing relative to IN_x decreasing
Reset Threshold Temperature Coefficient (TCV_{TH})		60		ppm/ $^\circ\text{C}$	
IN_x to Reset Delay (t_{RP})		30		μs	V_{IN} falling at 10 mV/ μs from V_{TH} to $V_{TH} - 50\text{ mV}$
Reset Timeout Period (t_{RP})	35	50	70	ms	
$\overline{\text{RESET}}$ Output Low (V_{OL})			0.3	V	$V_{IN2} = 5\text{ V}$, $I_{SINK} = 2\text{ mA}$
			0.4	V	$V_{IN2} = 2.5\text{ V}$, $I_{SINK} = 1.2\text{ mA}$
			0.3	V	$V_{IN2} = 1.0$, $I_{SINK} = 20\text{ }\mu\text{A}$, $T_A = 0^\circ\text{C to }+85^\circ\text{C}$
$\overline{\text{RESET}}$ Output High (V_{OH})	$0.8 \times V_{IN2}$			V	$V_{IN2} \geq 2.0\text{ V}$, $I_{SOURCE} = 4\text{ }\mu\text{A}$, $\overline{\text{RESET}}$ deasserted
$\overline{\text{RESET}}$ Output High Source Current (I_{OH})		10		μA	$V_{IN2} \geq 2.0\text{ V}$, $\overline{\text{RESET}}$ deasserted

¹ The $\overline{\text{RESET}}$ output is guaranteed to be in the correct state for IN_1 or IN_2 down to 1 V.

ABSOLUTE MAXIMUM RATINGS

Table 2.

Parameter	Rating
I_{N_x} , $\overline{\text{RESET}}$ to GND	-0.3 V to +6 V
Continuous $\overline{\text{RESET}}$ Current	20 mA
Storage Temperature Range	-65°C to +125°C
Operating Temperature Range	-40°C to +85°C
Lead Temperature (10 sec)	300°C
Junction Temperature	135°C

Stresses above those listed under Absolute Maximum Ratings may cause permanent damage to the device. This is a stress rating only; functional operation of the device at these or any other conditions above those indicated in the operational section of this specification is not implied. Exposure to absolute maximum rating conditions for extended periods may affect device reliability.

Table 3. Thermal Resistance

Package Type	θ_{JA}	Unit
6-lead SOT-23	169.5	°C/W

ESD CAUTION



ESD (electrostatic discharge) sensitive device.

Charged devices and circuit boards can discharge without detection. Although this product features patented or proprietary protection circuitry, damage may occur on devices subjected to high energy ESD. Therefore, proper ESD precautions should be taken to avoid performance degradation or loss of functionality.

PIN CONFIGURATION AND FUNCTION DESCRIPTIONS

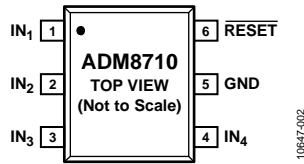

Figure 2. Pin Configuration

Table 4. Pin Function Descriptions

Pin No.	Mnemonic	Description
1	IN ₁	Input Voltage 1.
2	IN ₂	Input Voltage 2.
3	IN ₃	Input Voltage 3.
4	IN ₄	Input Voltage 4.
5	GND	Ground.
6	$\overline{\text{RESET}}$	Active Low $\overline{\text{RESET}}$ Output. $\overline{\text{RESET}}$ goes low when an input drops to less than the specified threshold. When all inputs rise higher than the threshold voltage, $\overline{\text{RESET}}$ remains low for the reset timeout period before going high. $\overline{\text{RESET}}$ is open drain with a weak internal pull-up to IN ₂ .

TYPICAL PERFORMANCE CHARACTERISTICS

$V_{IN2} = 3.0\text{ V}$, $T_A = 25^\circ\text{C}$, unless otherwise noted.

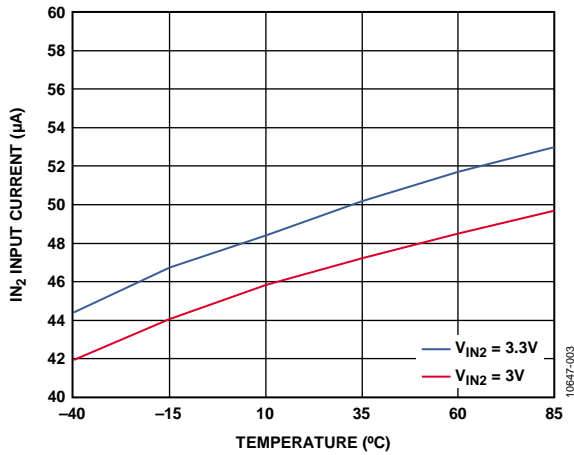

Figure 3. IN_2 Input Current vs. Temperature

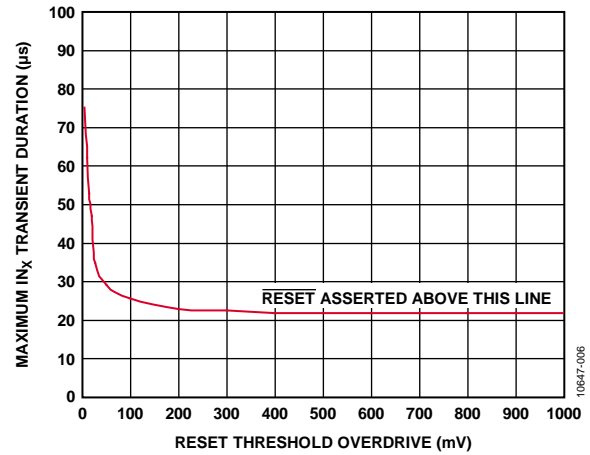

Figure 6. Maximum IN_x Transient Duration vs. Reset Threshold Overdrive

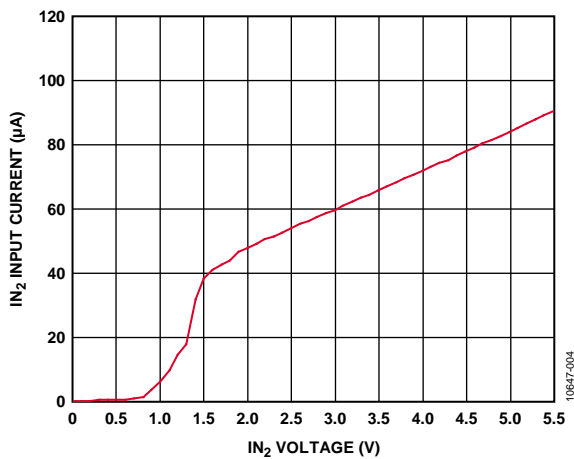

Figure 4. IN_2 Input Current vs. IN_2 Voltage

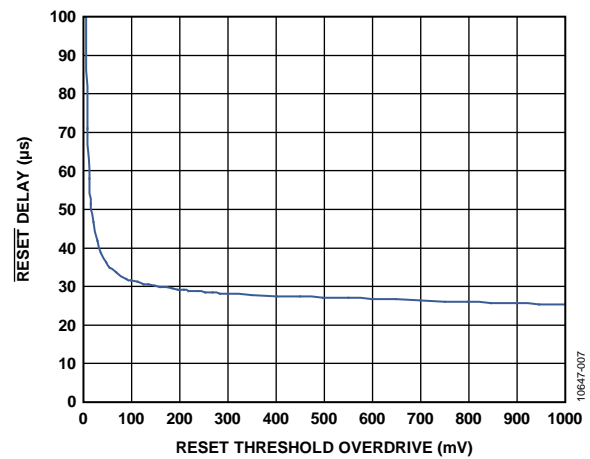

Figure 7. \overline{RESET} Delay vs. Reset Threshold Overdrive (IN_x Decreasing)

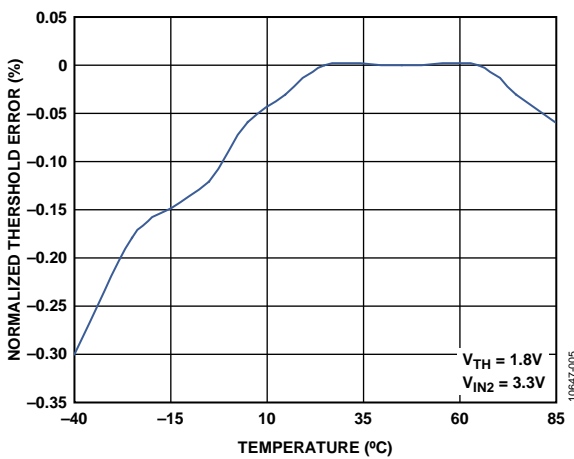

Figure 5. Normalized Threshold Error vs. Temperature

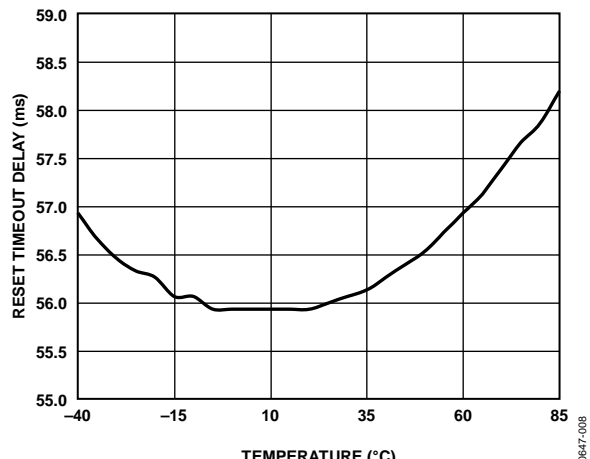

Figure 8. Normalized Reset Timeout Delay vs. Temperature

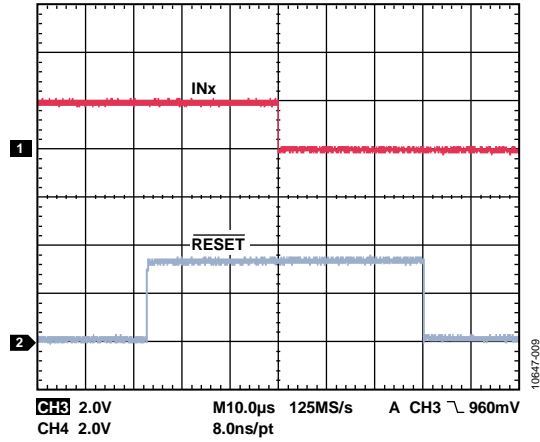

Figure 9. $\overline{\text{RESET}}$ Pull-Up and Pull-Down Response (10 $\mu\text{s}/\text{DIV}$)

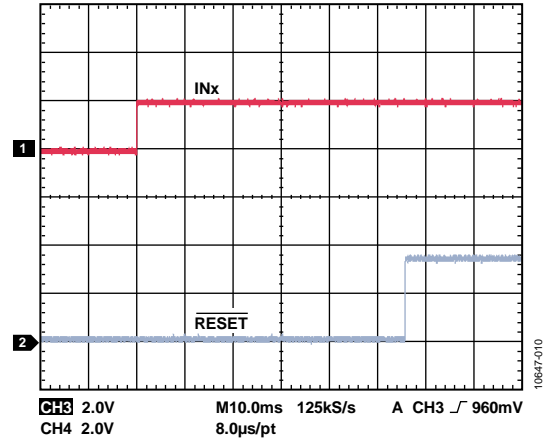

Figure 10. Timeout Delay (10 ms/DIV)

THEORY OF OPERATION

The ADM8710 is a compact, low power supervisory circuit capable of monitoring up to four voltages in a multisupply application.

The device includes two factory-set voltage threshold options for monitoring 1.8 V and 3.3 V supplies. It also provides two adjustable thresholds for monitoring voltages down to 0.62 V.

The ADM8710 is powered by IN_2 , which is a monitored voltage, and therefore monitors up to four voltages. If a monitored voltage drops below its associated threshold, the active low reset output asserts low and remains low while either IN_1 or IN_2 remains above 1.0 V.

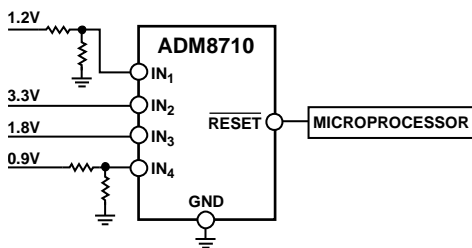

Figure 11. Typical Applications Circuit

INPUT CONFIGURATION

The ADM8710 provides numerous monitor choices with adjustable reset thresholds. Typically, the threshold voltage at each adjustable IN_x input is 0.62 V. To monitor a voltage greater than 0.62 V, connect a resistor divider network to the circuit as depicted in Figure 12, where

$$V_{INTH} = 0.62 V \left(\frac{R1 + R2}{R2} \right)$$

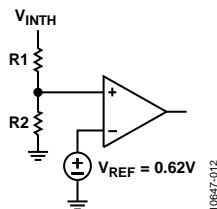

Figure 12. Setting the Adjustable Monitor

The internal comparators each typically have a hysteresis of 0.3% with respect to the reset threshold. This built-in hysteresis improves the immunity of the device to ambient noise without noticeably reducing the threshold accuracy. The ADM8710 is unaffected by short input transients.

The ADM8710 is powered from the monitored IN_2 . Monitored inputs are resistant to short power supply glitches. Figure 6 depicts the ADM8710 glitch immunity data. To increase noise immunity in noisy applications, place a 0.1 μ F capacitor between the IN_2 input and ground. Adding capacitance to IN_1 , IN_3 , and IN_4 also improves noise immunity.

Do not allow unused monitor inputs to float or to be grounded. Connect these inputs to a supply voltage greater than their specified threshold voltages. In the case of unused IN_x adjustable inputs, limit the bias current by connecting a 1 M Ω series resistor between the unused input and IN_2 .

RESET OUTPUT CONFIGURATION

The $\overline{\text{RESET}}$ output asserts low when a monitored IN_x voltage drops below its voltage threshold. When all voltages rise above the selected threshold level, the $\overline{\text{RESET}}$ signal remains low for the reset timeout period. The $\overline{\text{RESET}}$ output is open drain with a weak internal pull-up to the monitored IN_2 , typically 10 μ A.

Many applications that interface with other logic devices do not require an external pull-up resistor. However, if an external pull-up resistor is required and it is connected to a voltage ranging from 0 V to 5.5 V, it overdrives the internal pull-up. Reverse current flow from the external pull-up voltage to IN_2 is prevented by the internal circuitry.

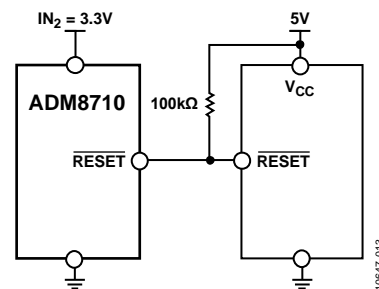

Figure 13. Interface with a Different Logic Supply Voltage

ADDITION OF MANUAL RESET

Use the circuit shown in Figure 14 to add manual reset to any of the ADM8710 adjustable inputs. When the switch is closed, the analog input shorts to ground and a $\overline{\text{RESET}}$ output commences. The switch must remain open for a minimum of 35 ms for the $\overline{\text{RESET}}$ output to deassert.

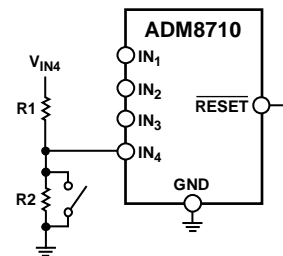

Figure 14. Addition of Manual Reset (IN_4 is an Adjustable Input)

TOLERANCE AND ACCURACY

The primary function of the voltage supervisor is to keep the processor in a reset state whenever the processor supply voltage is below the specification limit. It needs to be able to differentiate the voltage out-of-processor limit from supply variations caused by voltage converter output tolerance. This means that the supervisor rest threshold should fit inside the narrow band between processor input tolerance and supply tolerance.

The ADM8710 offers up to $\pm 2\%$ accuracy on factory trimmed monitoring thresholds and $\pm 1.5\%$ accuracy on adjustable thresholds over the entire operating temperature range.

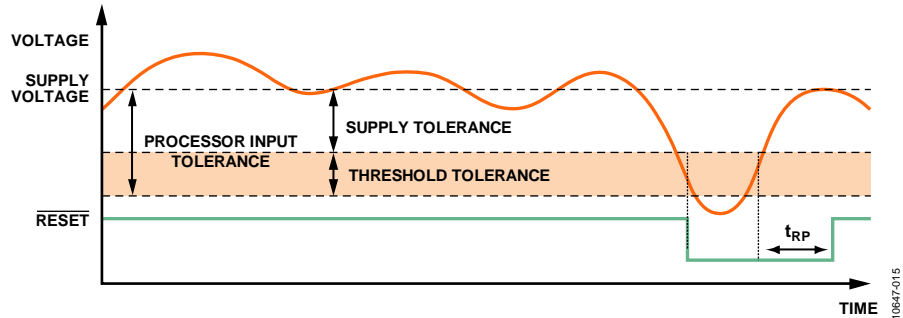

Figure 15. Tighter Threshold Tolerance on Voltage Supervisor Reduces Accuracy Requirement on Monitored Supply

MODEL OPTIONS

Table 5. Reset Voltage Threshold Options

Reset Threshold Code ¹	IN ₁		IN ₂		IN ₃		IN ₄	
	Nominal Input Voltage (V)	Supply Tolerance (%)	Nominal Input Voltage (V)	Supply Tolerance (%)	Nominal Input Voltage (V)	Supply Tolerance (%)	Nominal Input Voltage (V)	Supply Tolerance (%)
L	Adjustable	Not applicable	3.3	-5	1.8	-2	Adjustable	Not applicable

¹ Adjustable voltage based on 0.62 V internal threshold. The external threshold voltage can be set using an external resistor divider.

Table 6. Reset Timeout Options

Reset Timeout Period Code ¹	T _A = -40°C to +85°C			Unit
	Min	Typ	Max	
ADM8710x2	35	50	70	ms

¹x = do not care.

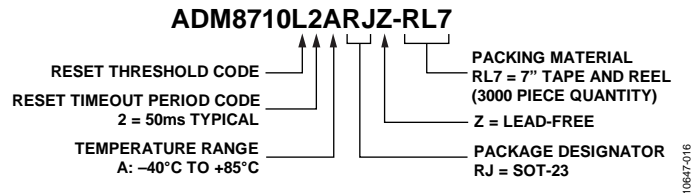
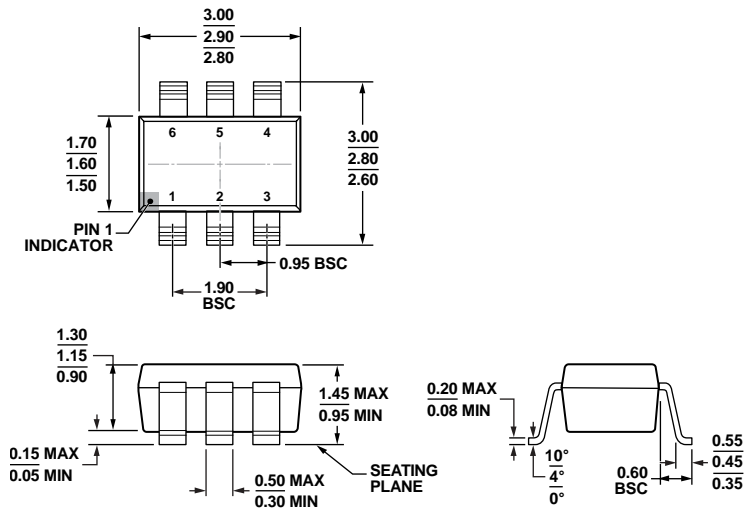

Figure 16. ADM8710 Ordering Code Structure

OUTLINE DIMENSIONS



COMPLIANT TO JEDEC STANDARDS MO-178-AB
 Figure 17. 6-Lead Small Outline Transistor Package [SOT-23]
 (RJ-6)
 Dimensions shown in millimeters

12-16-2008-A

ORDERING GUIDE

Model ^{1, 2}	Monitored Input Voltage (V)				Minimum Reset Timeout (ms)	Temperature Range	Ordering Quantity	Package Description	Package Option	Branding
	IN ₁	IN ₂	IN ₃	IN ₄						
ADM8710L2ARJZ-RL7	Adj.	3.07	1.73	Adj.	35	-40°C to +85°C	3,000	6-Lead SOT-23	RJ-6	LN3

¹ Z = RoHS Compliant Part.

² Adjustable voltage based on 0.62 V internal threshold. The external threshold voltage can be set using an external resistor divider.

NOTES