

# MMDFS6N303

## Power MOSFET 6 Amps, 30 Volts

### N-Channel SO-8, FETKY™

The FETKY product family incorporates low  $R_{DS(on)}$ , true logic level MOSFETs packaged with industry leading, low forward drop, low leakage Schottky Barrier rectifiers to offer high efficiency components in a space saving configuration. Independent pinouts for MOSFET and Schottky die allow the flexibility to use a single component for switching and rectification functions in a wide variety of applications such as Buck Converter, Buck-Boost, Synchronous Rectification, Low Voltage Motor Control, and Load Management in Battery Packs, Chargers, Cell Phones and other Portable Products.

#### Features

- Power MOSFET with Low  $V_F$
- Lower Component Placement and Inventory Costs along with Board Space Savings
- Logic Level Gate Drive — Can be Driven by Logic ICs
- Mounting Information for SO-8 Package Provided
- Applications Information Provided
- R2 Suffix for Tape and Reel (2500 units/13" reel)
- Marking: 6N303

#### MOSFET MAXIMUM RATINGS

( $T_J = 25^\circ\text{C}$  unless otherwise noted) (Note 1)

Rating	Symbol	Value	Unit
Drain-to-Source Voltage	$V_{DSS}$	30	Vdc
Drain-to-Gate Voltage ( $R_{GS} = 1.0\text{ M}\Omega$ )	$V_{DGR}$	30	Vdc
Gate-to-Source Voltage — Continuous	$V_{GS}$	$\pm 20$	Vdc
Drain Current (Note 2)			
- Continuous @ $T_A = 25^\circ\text{C}$	$I_D$	6.0	Adc
- Single Pulse ( $t_p \leq 10\ \mu\text{s}$ )	$I_{DM}$	30	Apk
Total Power Dissipation @ $T_A = 25^\circ\text{C}$ (Note 2)	$P_D$	2.0	Watts
Single Pulse Drain-to-Source Avalanche Energy — Startin $T_J = 25^\circ\text{C}$ $V_{DD} = 30\text{ Vdc}$ , $V_{GS} = 5.0\text{ Vdc}$ , $V_{DS} = 20$ $V_{dc}$ , $I_L = 9.0\text{ Apk}$ , $L = 10\text{ mH}$ , $R_G = 25\ \Omega$	$E_{AS}$	325	mJ

1. Pulse Test: Pulse Width  $\leq 250\ \mu\text{s}$ , Duty Cycle  $\leq 2.0\%$ .
2. Mounted on 2" square FR4 board (1" sq. 2 oz. Cu 0.06" thick single sided), 10 sec. max.



ON Semiconductor®

<http://onsemi.com>

**6 AMPERES**  
**30 VOLTS**  
 $R_{DS(on)} = 35\text{ m}\Omega$   
 $V_F = 0.42\text{ Volts}$

N-Channel

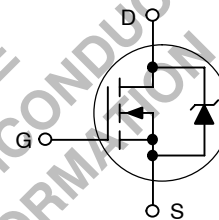

SO-8  
CASE 751  
STYLE 18

#### MARKING DIAGRAM

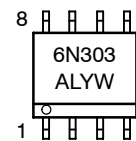

A = Assembly Location  
L = Wafer Lot  
Y = Year  
W = Work Week

#### PIN ASSIGNMENT

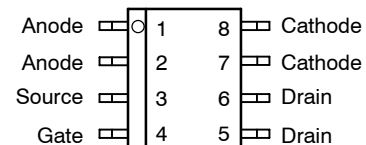

Top View

#### ORDERING INFORMATION

Device	Package	Shipping†
MMDFS6N303R2	SO-8	2500/Tape & Reel

†For information on tape and reel specifications, including part orientation and tape sizes, please refer to our Tape and Reel Packaging Specification Brochure, BRD8011/D.

# MMDFS6N303

## SCHOTTKY RECTIFIER MAXIMUM RATINGS ( $T_J = 25^\circ\text{C}$ unless otherwise noted)

Peak Repetitive Reverse Voltage DC Blocking Voltage	$V_{RRM}$ $V_R$	30	Volts
Average Forward Current (Note 3) (Rated $V_R$ ) $T_A = 104^\circ\text{C}$	$I_O$	2.0	Amps
Peak Repetitive Forward Current (Note 3) (Rated $V_R$ , Square Wave, 20 kHz) $T_A = 108^\circ\text{C}$	$I_{frm}$	4.0	Amps
Non-Repetitive Peak Surge Current (Surge applied at rated load conditions, halfwave, single phase, 60 Hz)	$I_{fsm}$	30	Amps

## THERMAL CHARACTERISTICS — SCHOTTKY AND MOSFET

Thermal Resistance — Junction-to-Ambient (Note 4) — MOSFET	$R_{\theta JA}$	167	$^\circ\text{C/W}$
Thermal Resistance — Junction-to-Ambient (Note 5) — MOSFET	$R_{\theta JA}$	97	
Thermal Resistance — Junction-to-Ambient (Note 2) — MOSFET	$R_{\theta JA}$	62.5	
Thermal Resistance — Junction-to-Ambient (Note 4) — Schottky	$R_{\theta JA}$	197	
Thermal Resistance — Junction-to-Ambient (Note 5) — Schottky	$R_{\theta JA}$	97	
Thermal Resistance — Junction-to-Ambient (Note 3) — Schottky	$R_{\theta JA}$	62.5	
Operating and Storage Temperature Range	$T_j, T_{stg}$	-55 to 150	

## MOSFET ELECTRICAL CHARACTERISTICS ( $T_C = 25^\circ\text{C}$ unless otherwise noted) (Note 6)

Characteristic	Symbol	Min	Typ	Max	Unit
----------------	--------	-----	-----	-----	------

### OFF CHARACTERISTICS

Drain-Source Voltage ( $V_{GS} = 0$ Vdc, $I_D = 0.25$ mA) Temperature Coefficient (Positive)	$V_{(BR)DSS}$	30	—	—	Vdc mV/ $^\circ\text{C}$
Zero Gate Drain Current ( $V_{DS} = 24$ Vdc, $V_{GS} = 0$ Vdc) ( $V_{DS} = 24$ Vdc, $V_{GS} = 0$ Vdc, $T_J = 125^\circ\text{C}$ )	$I_{DSS}$	—	—	1.0 20	$\mu\text{Adc}$
Gate Body Leakage Current ( $V_{GS} = \pm 20$ Vdc, $V_{DS} = 0$ )	$I_{GSS}$	—	—	100	nAdc

### ON CHARACTERISTICS (Note 6)

Gate Threshold Voltage ( $V_{DS} = V_{GS}$ , $I_D = 0.25$ mA) Temperature Coefficient (Negative)	$V_{GS(th)}$	1.0	—	—	Vdc
Static Drain-Source Resistance ( $V_{GS} = 10$ Vdc, $I_D = 5.0$ Adc) ( $V_{GS} = 4.5$ Vdc, $I_D = 3.9$ Adc)	$R_{DS(on)}$	—	28 42	35 50	$\text{m}\Omega$
Forward Transconductance ( $V_{DS} = 15$ Vdc, $I_D = 5.0$ Adc)	$g_{FS}$	—	9.0	—	mhos

### DYNAMIC CHARACTERISTICS

Input Capacitance	$(V_{DS} = 24$ Vdc, $V_{GS} = 0$ Vdc, $f = 1.0$ MHz)	$C_{iss}$	—	430	600	pF
Output Capacitance		$C_{oss}$	—	217	300	
Reverse Transfer Capacitance		$C_{rss}$	—	67.5	135	

- Mounted on 2" square FR4 board (1" sq. 2 oz. Cu 0.06" thick single sided), 10 sec. max.
- Mounted with minimum recommended pad size, PC Board FR4.
- Mounted on 2" square FR4 board (1" sq. 2 oz. Cu 0.06" thick single sided), Steady State.
- Pulse Test: Pulse Width  $\leq 300$   $\mu\text{s}$ , Duty Cycle  $\leq 2.0\%$ .

# MMDFS6N303

## MOSFET ELECTRICAL CHARACTERISTICS – continued ( $T_C = 25^\circ\text{C}$ unless otherwise noted) (Note 7)

Characteristic	Symbol	Min	Typ	Max	Unit
----------------	--------	-----	-----	-----	------

### SWITCHING CHARACTERISTICS (Note 8)

Turn-On Delay Time	$(V_{DD} = 15\text{ Vdc}, I_D = 1.0\text{ Adc}, V_{GS} = 10\text{ Vdc}, R_G = 6.0\ \Omega)$	$t_{d(on)}$	—	8.2	16.5	ns
Rise Time		$t_r$	—	8.5	17	
Turn-Off Delay Time		$t_{d(off)}$	—	89.6	179	
Fall Time		$t_f$	—	61.1	122	
Gate Charge	$(V_{DS} = 15\text{ Vdc}, I_D = 5.0\text{ Adc}, V_{GS} = 10\text{ Vdc})$	$Q_T$	—	15.7	31.4	nC
		$Q_1$	—	2.0	—	
		$Q_2$	—	4.6	—	
		$Q_3$	—	3.9	—	

### DRAIN SOURCE DIODE CHARACTERISTICS

Forward On-Voltage (Note 7)	$(I_S = 1.7\text{ Adc}, V_{GS} = 0\text{ Vdc})$	$V_{SD}$	—	0.77	1.2	Vdc
Reverse Recovery Time	$(V_{GS} = 0\text{ V}, I_S = 5.0\text{ A}, dI_S/dt = 100\text{ A}/\mu\text{s})$	$t_{rr}$	—	54.5	—	ns
		$t_a$	—	14.8	—	
		$t_b$	—	39.7	—	
Reverse Recovery Stored Charge		$Q_{RR}$	—	0.048	—	$\mu\text{C}$

### SCHOTTKY RECTIFIER ELECTRICAL CHARACTERISTICS ( $T_C = 25^\circ\text{C}$ unless otherwise noted)

Maximum Instantaneous Forward Voltage (Note 7) $I_F = 100\text{ mAdc}$ $I_F = 3.0\text{ Adc}$ $I_F = 6.0\text{ Adc}$	$V_F$	$T_J = 25^\circ\text{C}$	$T_J = 125^\circ\text{C}$	Volts
		0.28	0.13	
		0.42	0.33	
Maximum Instantaneous Reverse Current (Note 7) $V_R = 30\text{ V}$	$I_R$	$T_J = 25^\circ\text{C}$	$T_J = 125^\circ\text{C}$	$\mu\text{A}$
		250	—	
		—	25	$\text{mA}$
Maximum Voltage Rate of Change $V_R = 30\text{ V}$	$dV/dt$	10,000		$\text{V}/\mu\text{s}$

7. Pulse Test: Pulse Width  $\leq 300\ \mu\text{s}$ , Duty Cycle  $\leq 2.0\%$ .

8. Switching characteristics are independent of operating junction temperature.

TYPICAL FET ELECTRICAL CHARACTERISTICS

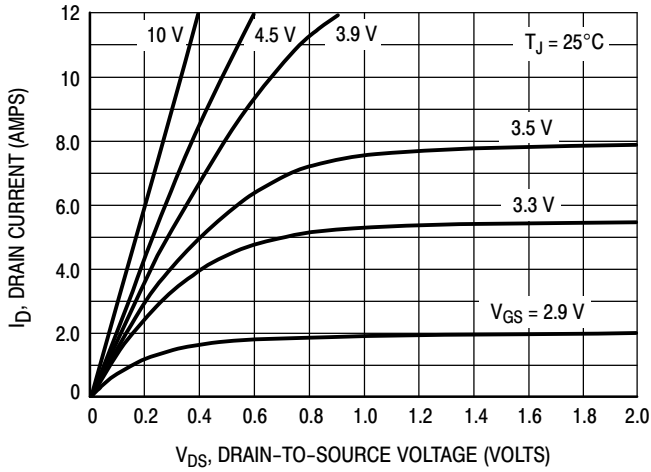

Figure 1. On-Region Characteristics

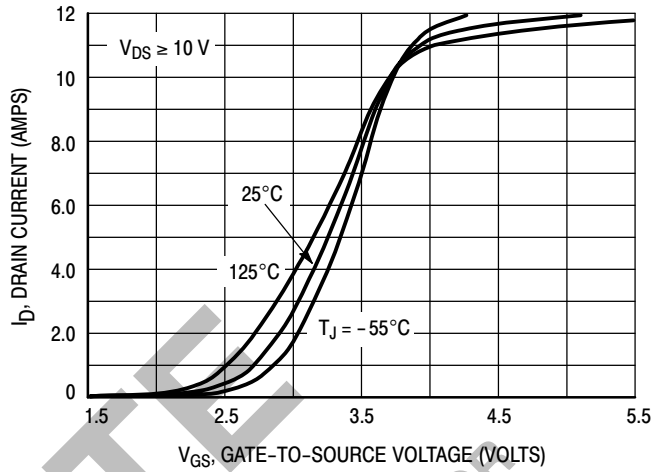

Figure 2. Transfer Characteristics

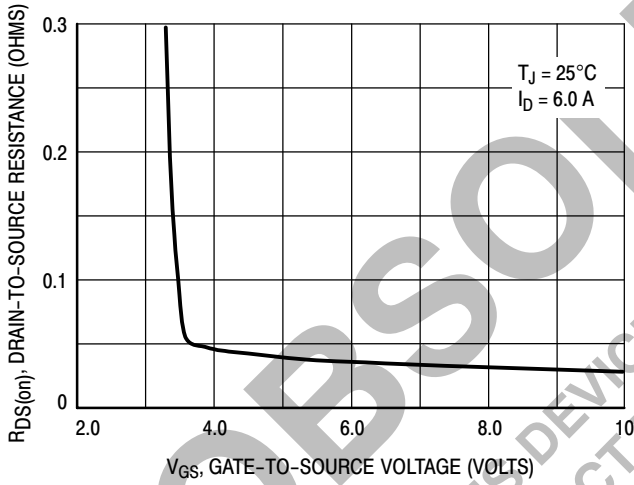

Figure 3. On-Resistance versus Gate-to-Source Voltage

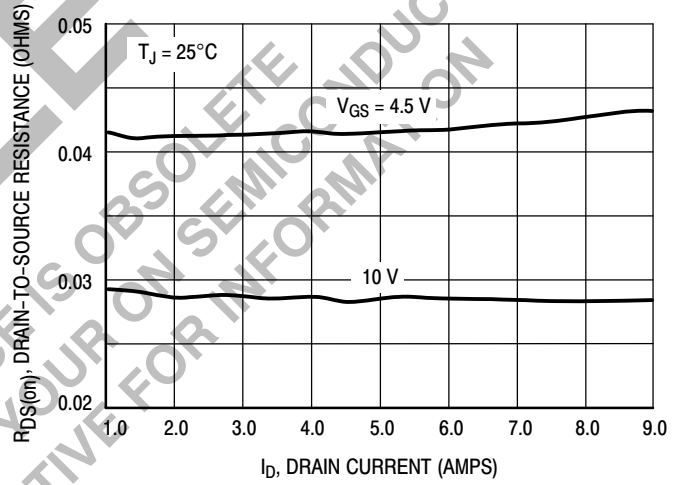

Figure 4. On-Resistance versus Drain Current and Gate Voltage

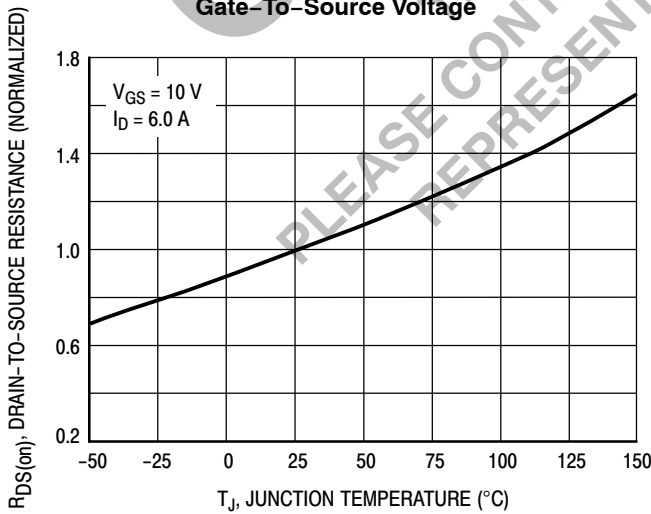

Figure 5. On-Resistance Variation with Temperature

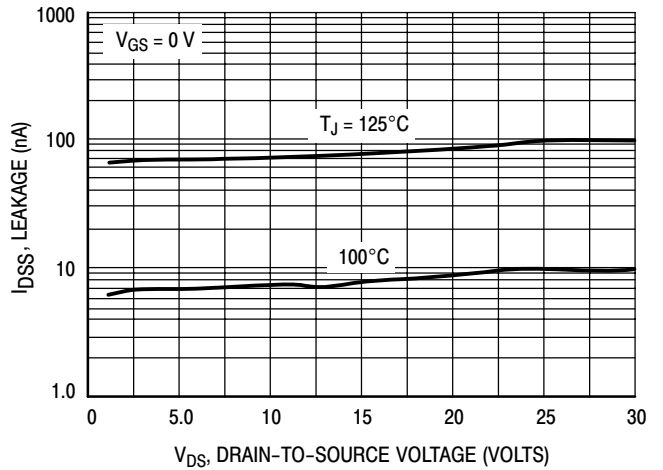

Figure 6. Drain-to-Source Leakage Current versus Voltage

TYPICAL FET ELECTRICAL CHARACTERISTICS

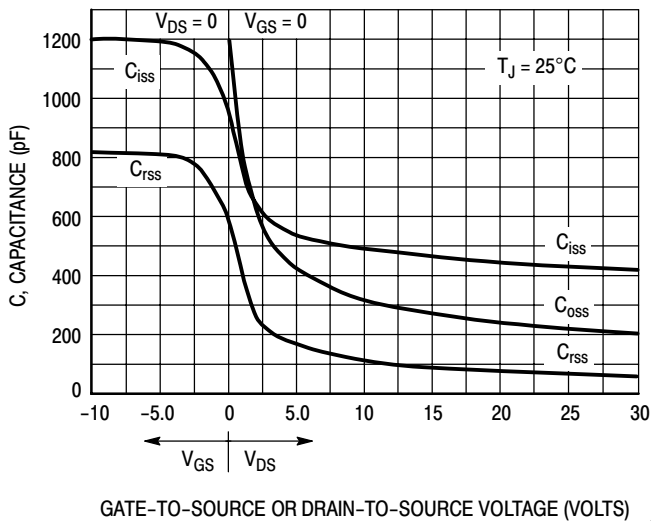

Figure 7. Capacitance Variation

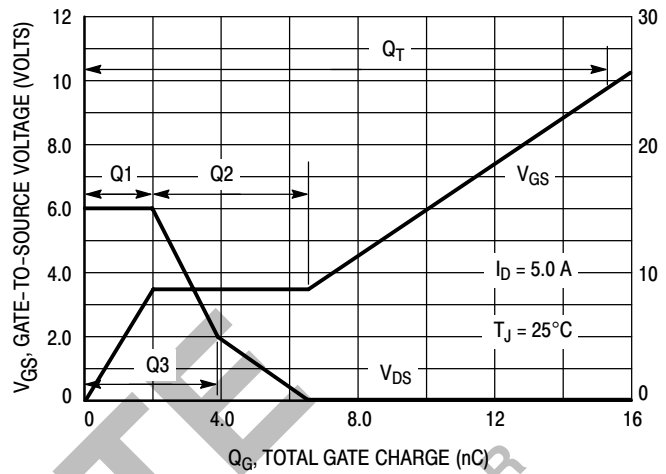

Figure 8. Gate-To-Source and Drain-To-Source Voltage versus Total Charge

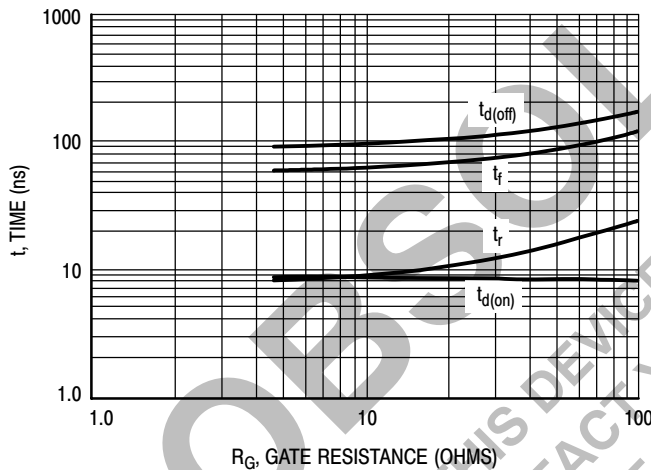

Figure 9. Resistive Switching Time Variation versus Gate Resistance

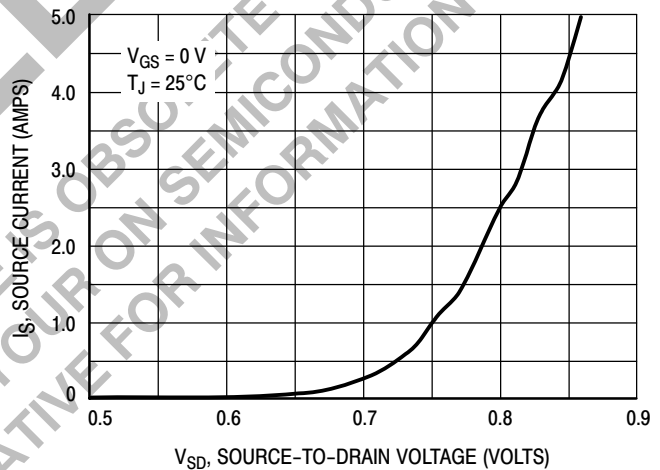

Figure 10. Diode Forward Voltage versus Current

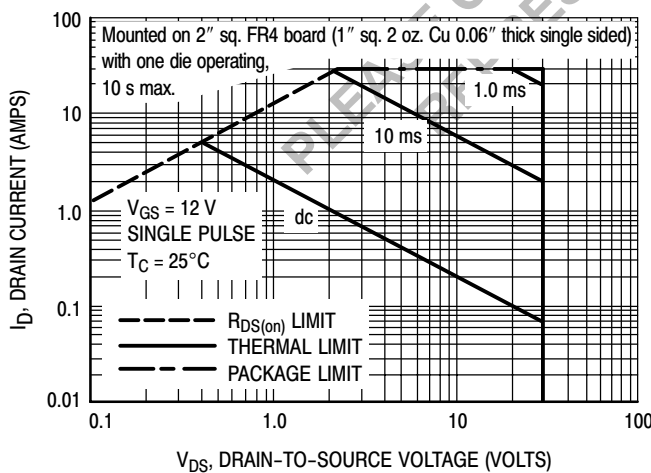

Figure 11. Maximum Rated Forward Biased Safe Operating Area

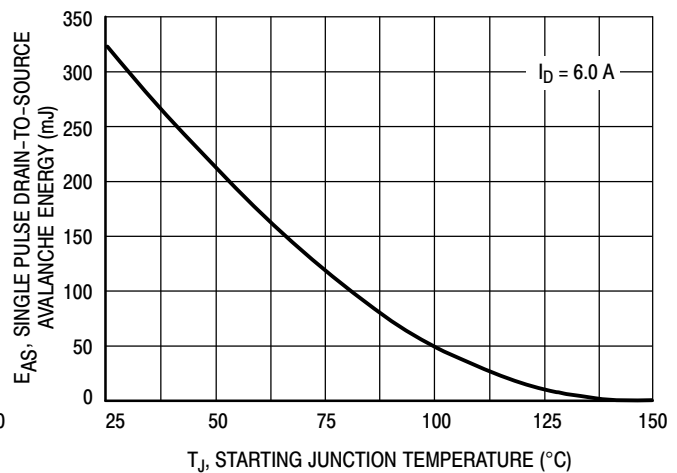

Figure 12. Maximum Avalanche Energy versus Starting Junction Temperature

TYPICAL FET ELECTRICAL CHARACTERISTICS

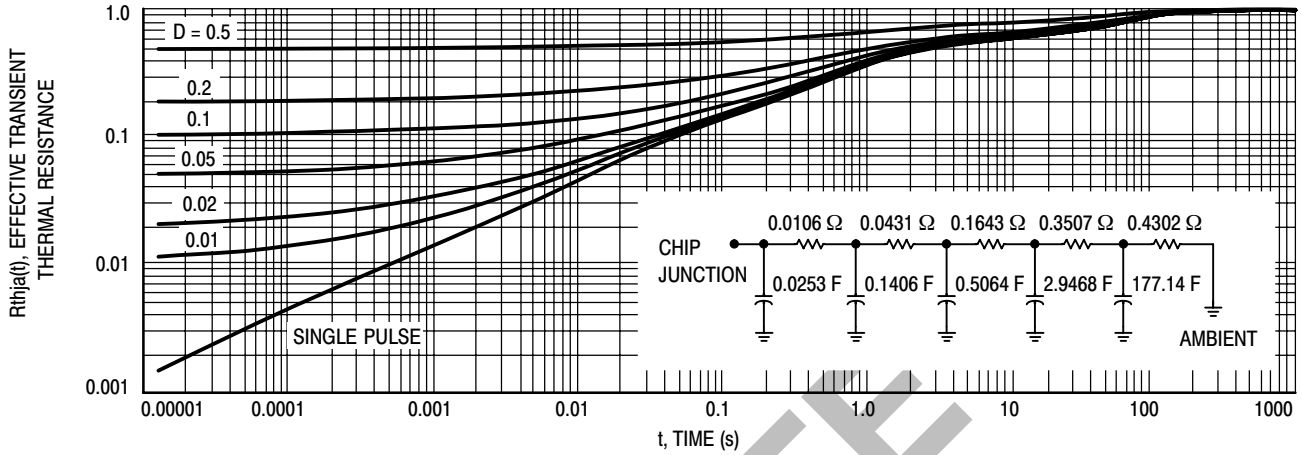

Figure 13. FET Thermal Response

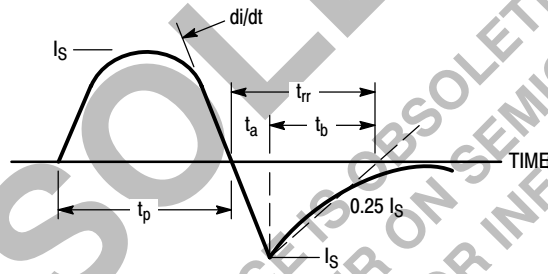

Figure 14. Diode Reverse Recovery Waveform

TYPICAL SCHOTTKY ELECTRICAL CHARACTERISTICS

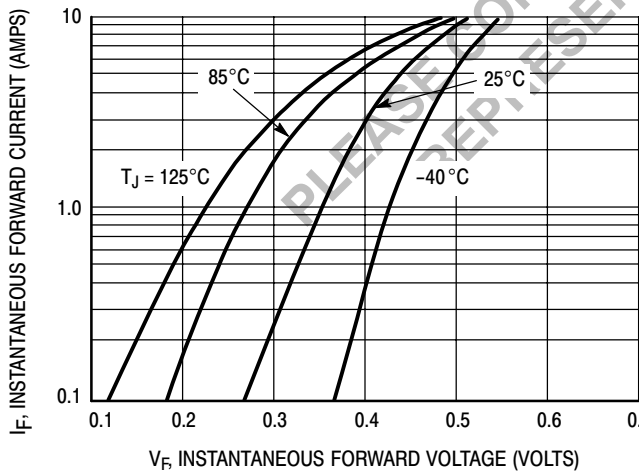

Figure 15. Typical Forward Voltage

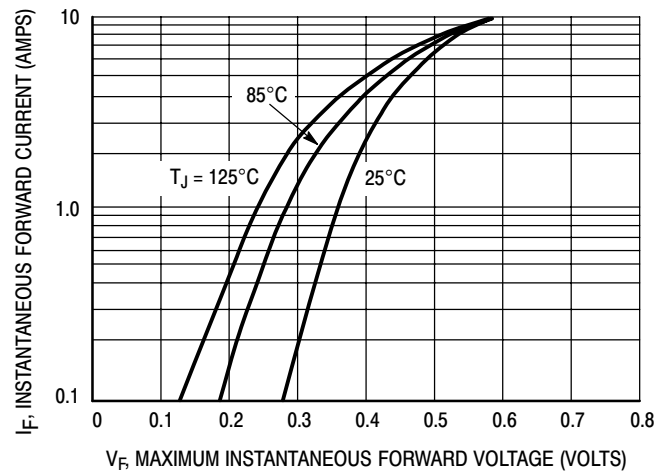

Figure 16. Maximum Forward Voltage

TYPICAL SCHOTTKY ELECTRICAL CHARACTERISTICS

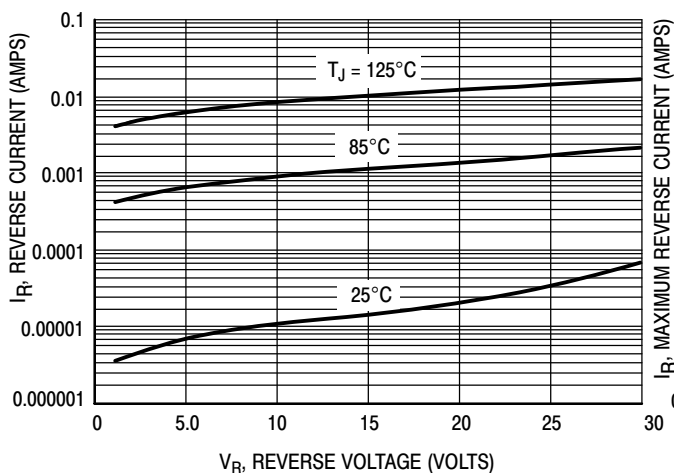

Figure 17. Typical Reverse Current

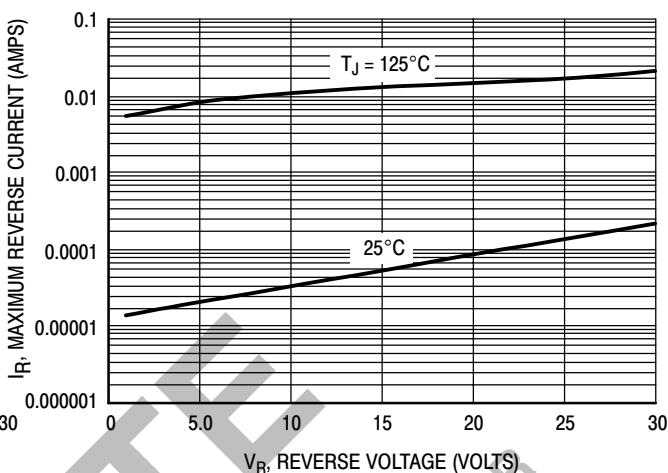

Figure 18. Maximum Reverse Current

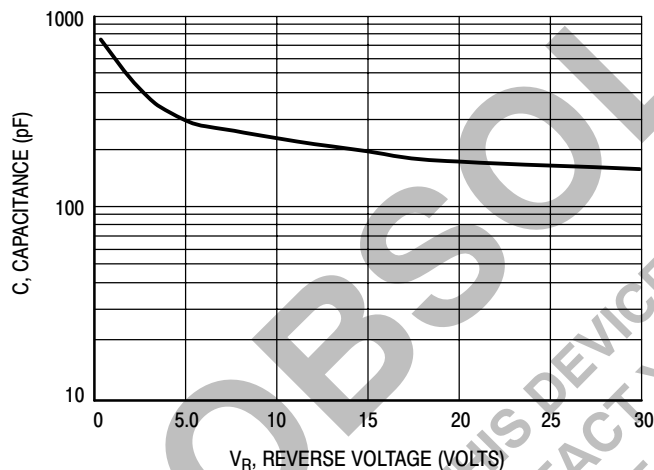

Figure 19. Typical Capacitance

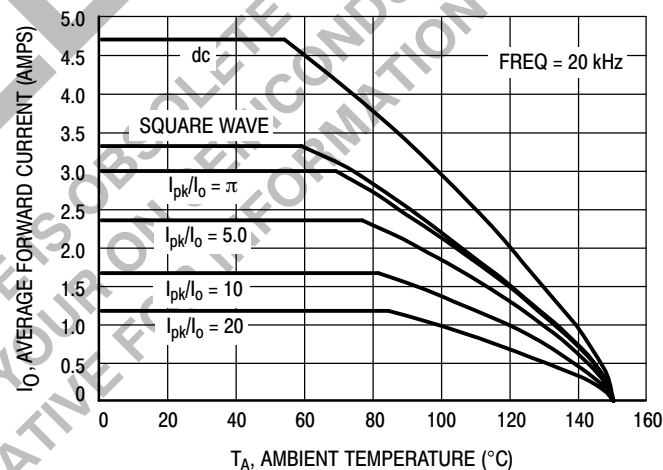

Figure 20. Current Derating

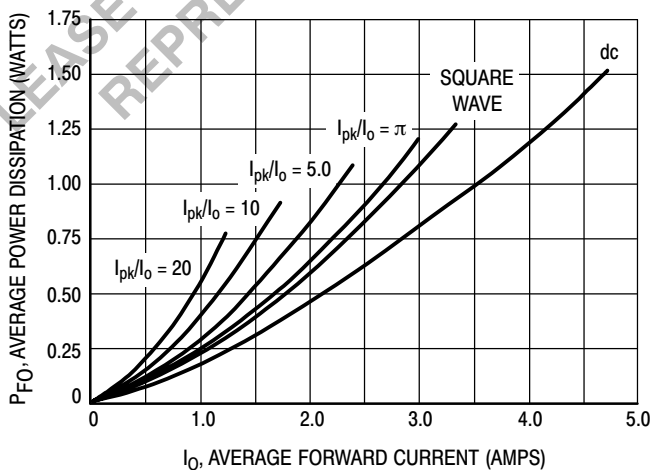

Figure 21. Forward Power Dissipation

TYPICAL SCHOTTKY ELECTRICAL CHARACTERISTICS

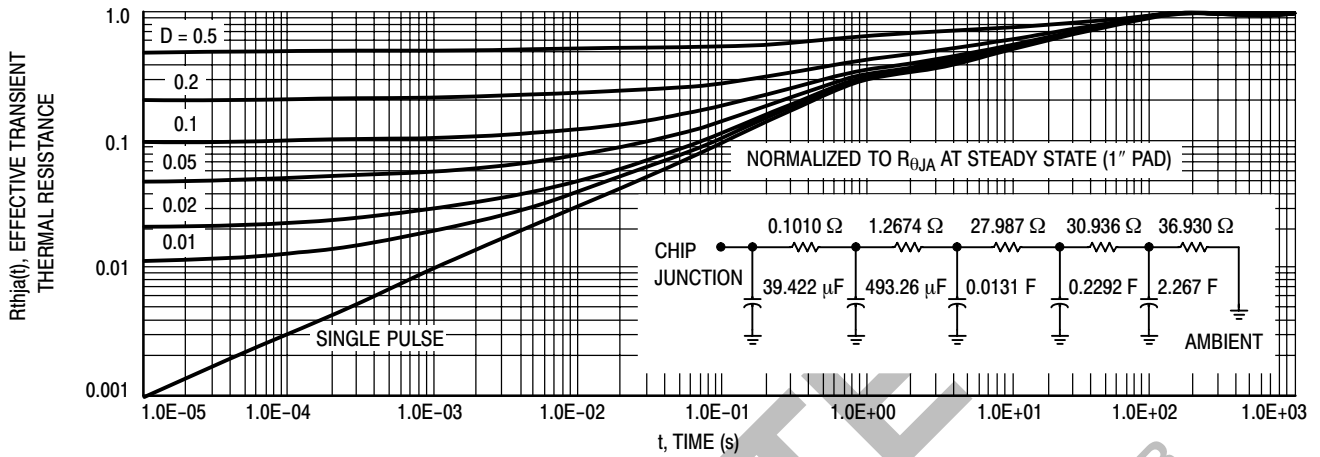
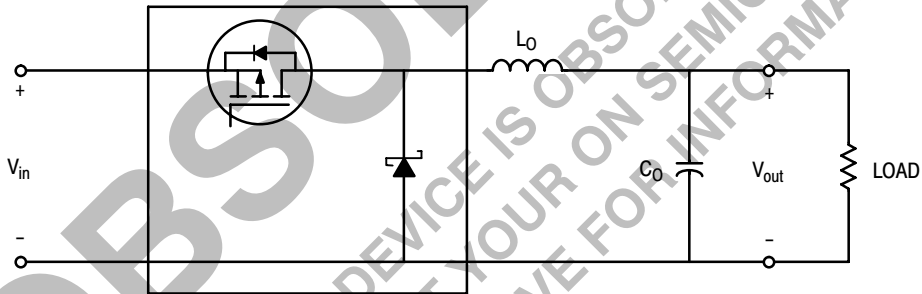

Figure 22. Schottky Thermal Response

TYPICAL APPLICATIONS

STEP DOWN SWITCHING REGULATORS



Buck Regulator

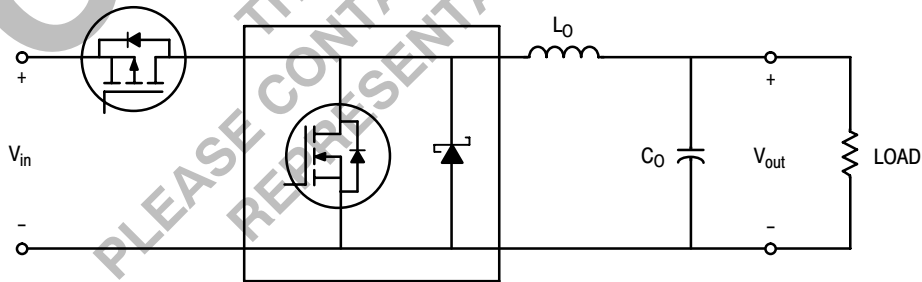

Synchronous Buck Regulator



# MMDFS6N303

## TYPICAL APPLICATIONS

### STEP UP SWITCHING REGULATORS

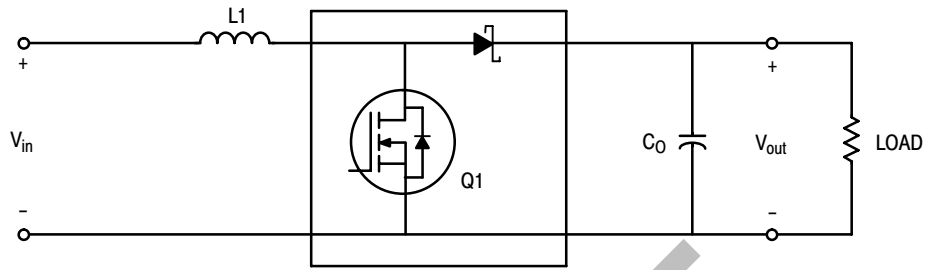

**Boost Regulator**

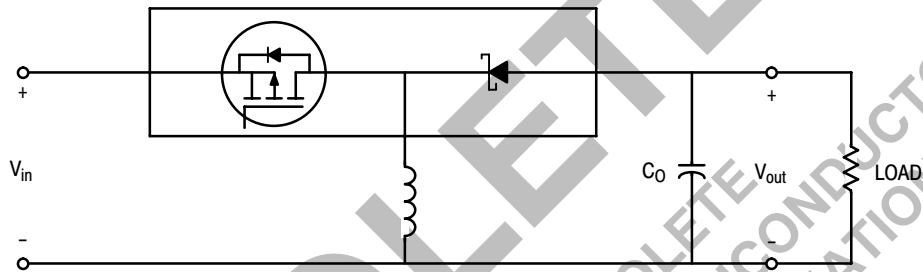

**Buck-Boost Regulator**

### MULTIPLE BATTERY CHARGERS

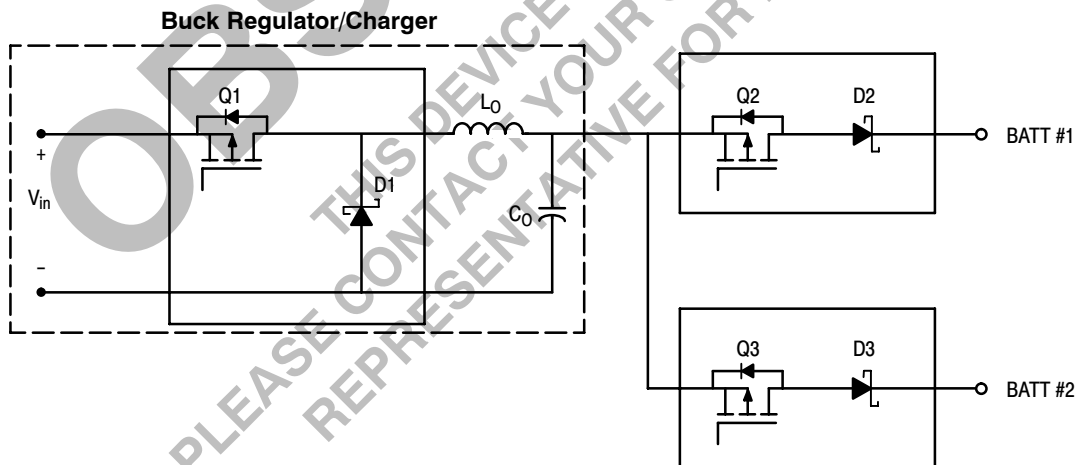

PLEASE CONTACT YOUR ONSEMI CONDUCTOR REPRESENTATIVE FOR INFORMATION

# MMDFS6N303

## TYPICAL APPLICATIONS

### Li-Ion BATTERY PACK APPLICATIONS

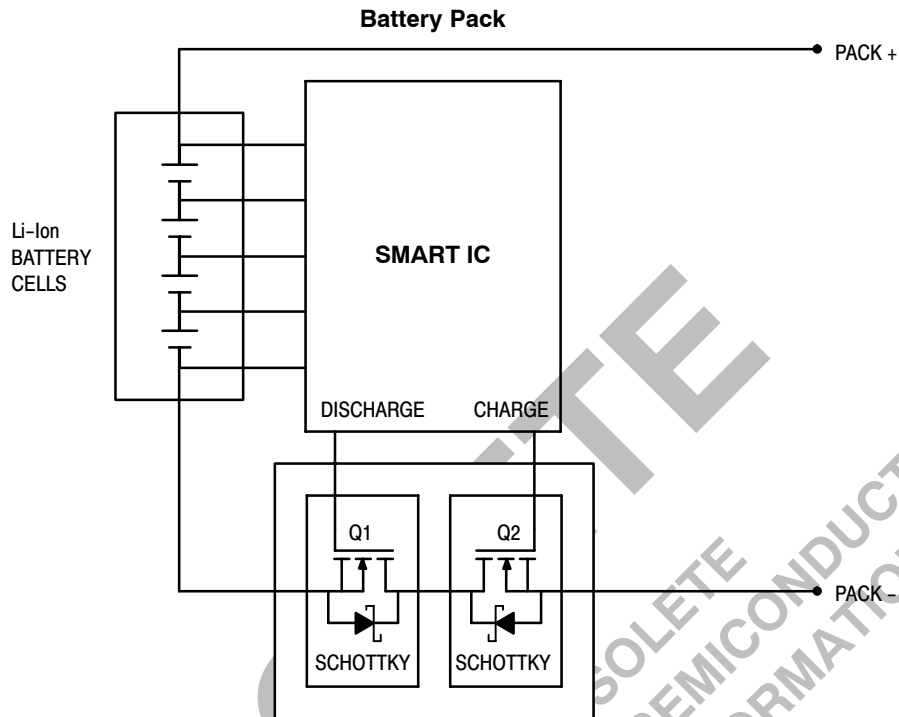

- Applicable in battery packs which require a high current level.
- During charge cycle Q2 is on and Q1 is off. Schottky can reduce power loss during fast charge.
- During discharge Q1 is on and Q2 is off. Again, Schottky can reduce power dissipation.
- Under normal operation, both transistors are on.

# MMDFS6N303

## PACKAGE DIMENSIONS

SO-8  
CASE 751-07  
ISSUE AB

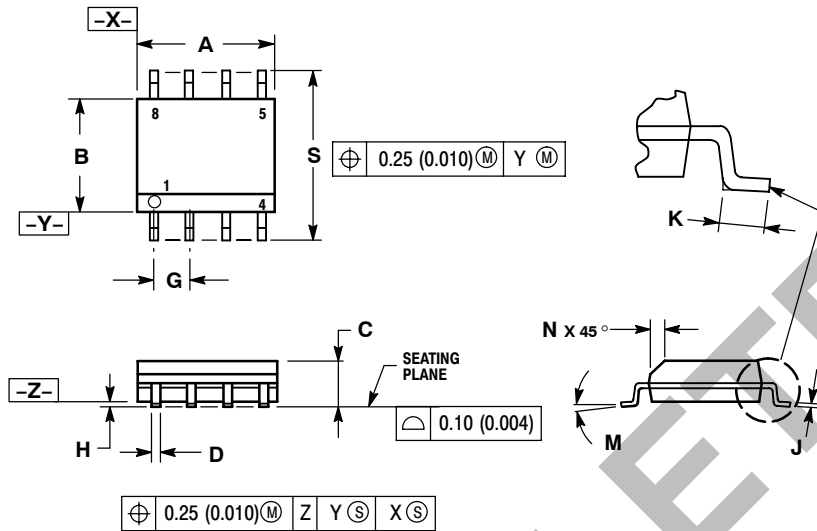

- NOTES:
1. DIMENSIONING AND TOLERANCING PER ANSI Y14.5M, 1982.
  2. CONTROLLING DIMENSION: MILLIMETER.
  3. DIMENSION A AND B DO NOT INCLUDE MOLD PROTRUSION.
  4. MAXIMUM MOLD PROTRUSION 0.15 (0.006) PER SIDE.
  5. DIMENSION D DOES NOT INCLUDE DAMBAR PROTRUSION. ALLOWABLE DAMBAR PROTRUSION SHALL BE 0.127 (0.005) TOTAL IN EXCESS OF THE D DIMENSION AT MAXIMUM MATERIAL CONDITION.
  6. 751-01 THRU 751-06 ARE OBSOLETE. NEW STANDARD IS 751-07.

DIM	MILLIMETERS		INCHES	
	MIN	MAX	MIN	MAX
A	4.80	5.00	0.189	0.197
B	3.80	4.00	0.150	0.157
C	1.35	1.75	0.053	0.069
D	0.33	0.51	0.013	0.020
G	1.27 BSC		0.050 BSC	
H	0.10	0.25	0.004	0.010
J	0.19	0.25	0.007	0.010
K	0.40	1.27	0.016	0.050
M	0°	8°	0°	8°
N	0.25	0.50	0.010	0.020
S	5.80	6.20	0.228	0.244

- STYLE 18:
1. ANODE
  2. ANODE
  3. SOURCE
  4. GATE
  5. DRAIN
  6. DRAIN
  7. CATHODE
  8. CATHODE

### SOLDERING FOOTPRINT\*

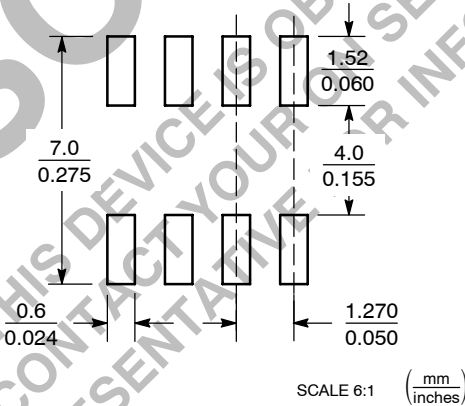

\*For additional information on our Pb-Free strategy and soldering details, please download the ON Semiconductor Soldering and Mounting Techniques Reference Manual, SOLDERRM/D.

FETKY is a trademark of International Rectifier Corporation.

ON Semiconductor and are registered trademarks of Semiconductor Components Industries, LLC (SCILLC). SCILLC reserves the right to make changes without further notice to any products herein. SCILLC makes no warranty, representation or guarantee regarding the suitability of its products for any particular purpose, nor does SCILLC assume any liability arising out of the application or use of any product or circuit, and specifically disclaims any and all liability, including without limitation special, consequential or incidental damages. "Typical" parameters which may be provided in SCILLC data sheets and/or specifications can and do vary in different applications and actual performance may vary over time. All operating parameters, including "Typicals" must be validated for each customer application by customer's technical experts. SCILLC does not convey any license under its patent rights nor the rights of others. SCILLC products are not designed, intended, or authorized for use as components in systems intended for surgical implant into the body, or other applications intended to support or sustain life, or for any other application in which the failure of the SCILLC product could create a situation where personal injury or death may occur. Should Buyer purchase or use SCILLC products for any such unintended or unauthorized application, Buyer shall indemnify and hold SCILLC and its officers, employees, subsidiaries, affiliates, and distributors harmless against all claims, costs, damages, and expenses, and reasonable attorney fees arising out of, directly or indirectly, any claim of personal injury or death associated with such unintended or unauthorized use, even if such claim alleges that SCILLC was negligent regarding the design or manufacture of the part. SCILLC is an Equal Opportunity/Affirmative Action Employer. This literature is subject to all applicable copyright laws and is not for resale in any manner.

### PUBLICATION ORDERING INFORMATION

**LITERATURE FULFILLMENT:**  
Literature Distribution Center for ON Semiconductor  
P.O. Box 5163, Denver, Colorado 80217 USA  
**Phone:** 303-675-2175 or 800-344-3860 Toll Free USA/Canada  
**Fax:** 303-675-2176 or 800-344-3867 Toll Free USA/Canada  
**Email:** orderlit@onsemi.com

**N. American Technical Support:** 800-282-9855 Toll Free  
USA/Canada

**Japan:** ON Semiconductor, Japan Customer Focus Center  
2-9-1 Kamimeguro, Meguro-ku, Tokyo, Japan 153-0051  
**Phone:** 81-3-5773-3850

**ON Semiconductor Website:** <http://onsemi.com>

**Order Literature:** <http://www.onsemi.com/litorder>

For additional information, please contact your local Sales Representative.

MMDFS6N303/D