

Dual N-Channel 30 V (D-S) MOSFET

PRODUCT SUMMARY				
	V _{DS} (V)	R _{DS(on)} (Ω)	I _D (A) ^a	Q _g (Typ.)
Channel 1	30	0.0153 at V _{GS} = 10 V	8 ^e	8.4
		0.0184 at V _{GS} = 4.5 V	8 ^e	
Channel 2	30	0.0280 at V _{GS} = 10 V	8	3.6
		0.0340 at V _{GS} = 4.5 V	7.1	

FEATURES

- TrenchFET[®] Power MOSFET
- 100 % R_G Tested
- 100 % UIS Tested
- Compliant to RoHS Directive 2002/95/EC

RoHS
COMPLIANT

APPLICATIONS

- DC/DC for Notebook PC

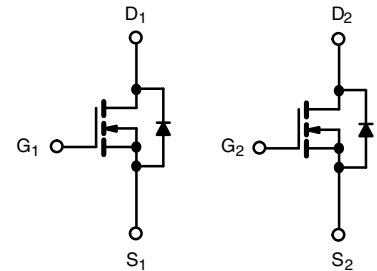
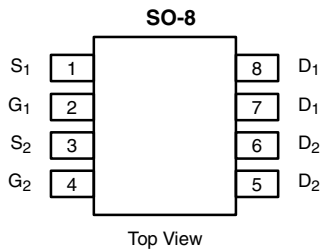

N-Channel MOSFET N-Channel MOSFET

Ordering Information: Si4276DY-T1-E3 (Lead (Pb)-free)

ABSOLUTE MAXIMUM RATINGS (T _A = 25 °C, unless otherwise noted)					
Parameter	Symbol	Channel 1	Channel 2	Unit	
Drain-Source Voltage	V _{DS}	30		V	
Gate-Source Voltage	V _{GS}	± 20			
Continuous Drain Current (T _J = 150 °C)	I _D	T _C = 25 °C	8 ^e	8	
		T _C = 70 °C	8 ^e	6.4	
		T _A = 25 °C	8 ^{b, c, e}	6.8 ^{b, c}	
		T _A = 70 °C	7.6 ^{b, c}	5.5 ^{b, c}	
Pulsed Drain Current (10 μs Pulse Width)	I _{DM}	50	30	A	
Source-Drain Current Diode Current	I _S	T _C = 25 °C	3.0		2.3
		T _A = 25 °C	1.7 ^{b, c}		1.7 ^{b, c}
Single Pulse Avalanche Current	I _{AS}	20	10		mJ
Avalanche Energy	E _{AS}	20	5		
Maximum Power Dissipation	P _D	T _C = 25 °C	3.6	2.8	
		T _C = 70 °C	2.3	1.8	
		T _A = 25 °C	2.1 ^{b, c}	2.0 ^{b, c}	
		T _A = 70 °C	1.3 ^{b, c}	1.3 ^{b, c}	
Operating Junction and Storage Temperature Range	T _J , T _{stg}	- 55 to 150		°C	

THERMAL RESISTANCE RATINGS							
Parameter	Symbol	Channel 1		Channel 2		Unit	
		Typical	Maximum	Typical	Maximum		
Maximum Junction-to-Ambient ^{b, d}	t ≤ 10 s	R _{thJA}	47	60	58	62.5	°C/W
Maximum Junction-to-Foot (Drain)	Steady	R _{thJF}	30	35	38	45	

Notes:

- Based on T_C = 25 °C.
- Surface mounted on 1" x 1" FR4 board.
- t = 10 s.
- Maximum under steady state conditions is 107 °C/W (Ch 1) and 110 °C/W (Ch 2).
- Package limited.

SPECIFICATIONS ($T_J = 25\text{ }^\circ\text{C}$, unless otherwise noted)							
Parameter	Symbol	Test Conditions	Min.	Typ. ^a	Max.	Unit	
Static							
Drain-Source Breakdown Voltage	V_{DS}	$V_{GS} = 0\text{ V}, I_D = 250\text{ }\mu\text{A}$	Ch 1	30			V
		$V_{GS} = 0\text{ V}, I_D = 250\text{ }\mu\text{A}$	Ch 2	30			
V_{DS} Temperature Coefficient	$\Delta V_{DS}/T_J$	$I_D = 250\text{ }\mu\text{A}$	Ch 1		29		mV/ $^\circ\text{C}$
		$I_D = 250\text{ }\mu\text{A}$	Ch 2		30		
$V_{GS(th)}$ Temperature Coefficient	$\Delta V_{GS(th)}/T_J$	$I_D = 250\text{ }\mu\text{A}$	Ch 1		- 5.2		
		$I_D = 250\text{ }\mu\text{A}$	Ch 2		- 4.4		
Gate Threshold Voltage	$V_{GS(th)}$	$V_{DS} = V_{GS}, I_D = 250\text{ }\mu\text{A}$	Ch 1	1.2		2.5	V
		$V_{DS} = V_{GS}, I_D = 250\text{ }\mu\text{A}$	Ch 2	1.2		2.5	
Gate-Body Leakage	I_{GSS}	$V_{DS} = 0\text{ V}, V_{GS} = \pm 20\text{ V}$	Ch 1			100	nA
			Ch 2			100	
Zero Gate Voltage Drain Current	I_{DSS}	$V_{DS} = 30\text{ V}, V_{GS} = 0\text{ V}$	Ch 1			1	μA
		$V_{DS} = 30\text{ V}, V_{GS} = 0\text{ V}$	Ch 2			1	
		$V_{DS} = 30\text{ V}, V_{GS} = 0\text{ V}, T_J = 55\text{ }^\circ\text{C}$	Ch 1			10	
		$V_{DS} = 30\text{ V}, V_{GS} = 0\text{ V}, T_J = 55\text{ }^\circ\text{C}$	Ch 2			10	
On-State Drain Current ^b	$I_{D(on)}$	$V_{DS} = 5\text{ V}, V_{GS} = 10\text{ V}$	Ch 1	10			A
		$V_{DS} = 5\text{ V}, V_{GS} = 10\text{ V}$	Ch 2	10			
Drain-Source On-State Resistance ^b	$R_{DS(on)}$	$V_{GS} = 10\text{ V}, I_D = 9.5\text{ A}$	Ch 1		0.0127	0.0153	Ω
		$V_{GS} = 10\text{ V}, I_D = 6.8\text{ A}$	Ch 2		0.0230	0.0280	
		$V_{GS} = 4.5\text{ V}, I_D = 8.7\text{ A}$	Ch 1		0.0146	0.0184	
		$V_{GS} = 4.5\text{ V}, I_D = 6.1\text{ A}$	Ch 2		0.0280	0.0340	
Forward Transconductance ^b	g_{fs}	$V_{DS} = 15\text{ V}, I_D = 9.5\text{ A}$	Ch 1		43		S
		$V_{DS} = 15\text{ V}, I_D = 6.8\text{ A}$	Ch 2		17		
Dynamic^a							
Input Capacitance	C_{iss}	Channel 1 $V_{DS} = 15\text{ V}, V_{GS} = 0\text{ V}, f = 1\text{ MHz}$ Channel 2 $V_{DS} = 15\text{ V}, V_{GS} = 0\text{ V}, f = 1\text{ MHz}$	Ch 1		1000		μF
			Ch 2		366		
Output Capacitance	C_{oss}		Ch 1		215		
			Ch 2		82		
Reverse Transfer Capacitance	C_{rss}		Ch 1		85		
			Ch 2		45		
Total Gate Charge	Q_g	$V_{DS} = 15\text{ V}, V_{GS} = 10\text{ V}, I_D = 9.5\text{ A}$	Ch 1		17.2	26	nC
		$V_{DS} = 15\text{ V}, V_{GS} = 10\text{ V}, I_D = 6.8\text{ A}$	Ch 2		7.3	15	
		Channel 1 $V_{DS} = 15\text{ V}, V_{GS} = 4.5\text{ V}, I_D = 9.5\text{ A}$	Ch 1		8.4	17	
			Ch 2		3.6	8	
Gate-Source Charge	Q_{gs}	Channel 2 $V_{DS} = 15\text{ V}, V_{GS} = 4.5\text{ V}, I_D = 6.8\text{ A}$	Ch 1		3		
			Ch 2		1.1		
Gate-Drain Charge	Q_{gd}	Ch 1		2.6			
		Ch 2		1.3			
Gate Resistance	R_g	$f = 1\text{ MHz}$	Ch 1	0.6	3.1	6.2	Ω
			Ch 2	0.5	2.6	5.2	



SPECIFICATIONS (T _J = 25 °C, unless otherwise noted)							
Parameter	Symbol	Test Conditions	Min.	Typ. ^a	Max.	Unit	
Dynamic^a							
Turn-On Delay Time	t _{d(on)}	Channel 1 V _{DD} = 15 V, R _L = 2 Ω I _D ≅ 7.6 A, V _{GEN} = 10 V, R _g = 1 Ω	Ch 1		8	16	ns
			Ch 2		4	8	
Rise Time	t _r		Ch 1		10	20	
			Ch 2		8	16	
Turn-Off Delay Time	t _{d(off)}	Channel 2 V _{DD} = 15 V, R _L = 2.7 Ω I _D ≅ 5.5 A, V _{GEN} = 10 V, R _g = 1 Ω	Ch 1		20	30	
			Ch 2		11	20	
Fall Time	t _f		Ch 1		7	14	
			Ch 2		7	14	
Turn-On Delay Time	t _{d(on)}	Channel 1 V _{DD} = 15 V, R _L = 2 Ω I _D ≅ 7.6 A, V _{GEN} = 4.5 V, R _g = 1 Ω	Ch 1		14	21	
			Ch 2		8	16	
Rise Time	t _r		Ch 1		11	20	
			Ch 2		10	20	
Turn-Off Delay Time	t _{d(off)}	Channel 2 V _{DD} = 15 V, R _L = 2.7 Ω I _D ≅ 5.5 A, V _{GEN} = 4.5 V, R _g = 1 Ω	Ch 1		18	27	
			Ch 2		10	20	
Fall Time	t _f		Ch 1		7	14	
			Ch 2		7	14	
Drain-Source Body Diode Characteristics							
Continuous Source-Drain Diode Current	I _S	T _C = 25 °C	Ch 1			3	A
			Ch 2			2.3	
Pulse Diode Forward Current ^a	I _{SM}		Ch 1			50	
			Ch 2			30	
Body Diode Voltage	V _{SD}	I _S = 7.6 A	Ch 1		0.82	1.2	V
		I _S = 5.5 A	Ch 2		0.85	1.2	
Body Diode Reverse Recovery Time	t _{rr}	Channel 1 I _F = 7.7 A, di/dt = 100 A/μs, T _J = 25 °C	Ch 1		20	30	ns
			Ch 2		13	20	
Body Diode Reverse Recovery Charge	Q _{rr}		Ch 1		12	20	nC
			Ch 2		6	12	
Reverse Recovery Fall Time	t _a	Channel 2 I _F = 5.5 A, di/dt = 100 A/μs, T _J = 25 °C	Ch 1		11		ns
			Ch 2		7		
Reverse Recovery Rise Time	t _b		Ch 1		9		
			Ch 2		6		

Notes:

- a. Guaranteed by design, not subject to production testing.
- b. Pulse test; pulse width ≤ 300 μs, duty cycle ≤ 2 %.

Stresses beyond those listed under "Absolute Maximum Ratings" may cause permanent damage to the device. These are stress ratings only, and functional operation of the device at these or any other conditions beyond those indicated in the operational sections of the specifications is not implied. Exposure to absolute maximum rating conditions for extended periods may affect device reliability.

CHANNEL-1 TYPICAL CHARACTERISTICS (25 °C, unless otherwise noted)

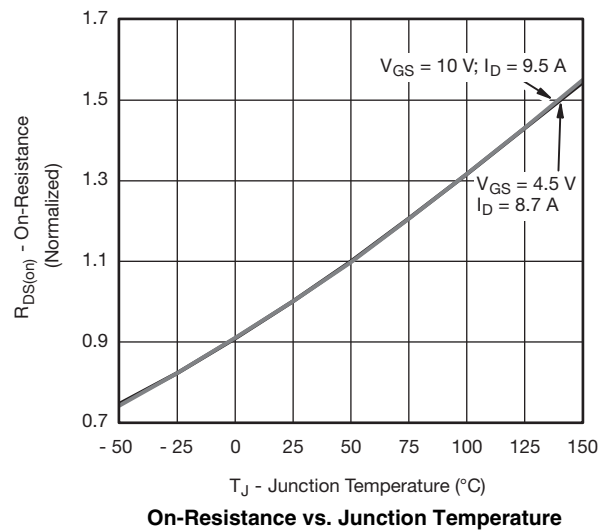
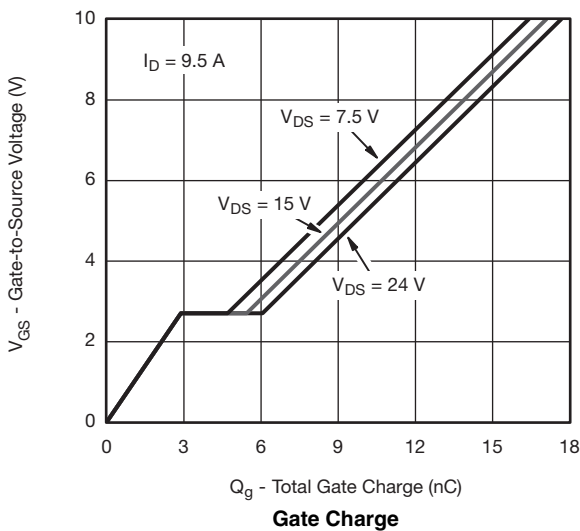
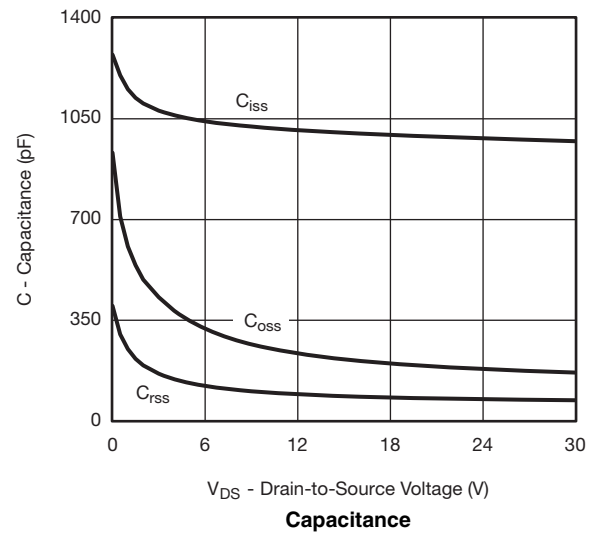
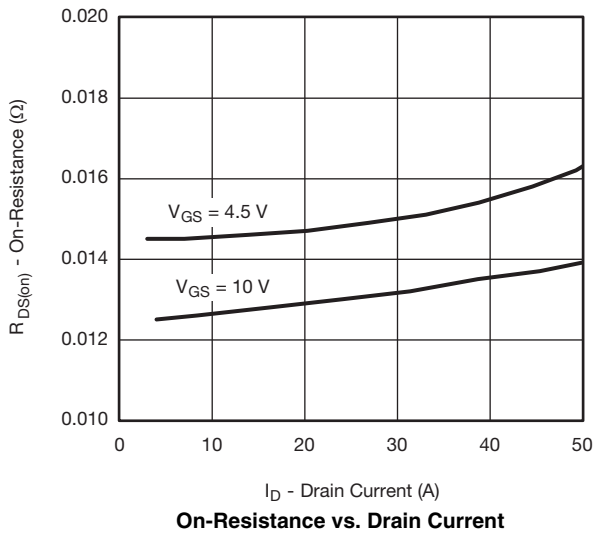
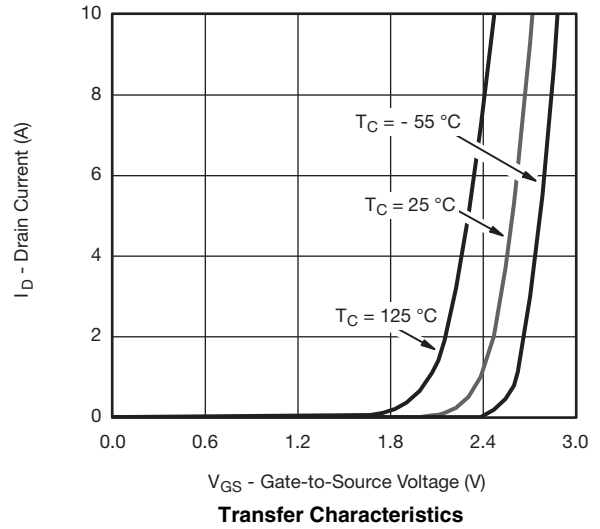
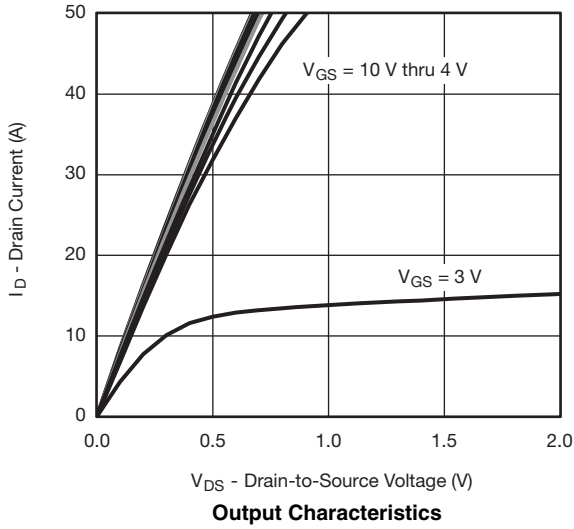

CHANNEL-1 TYPICAL CHARACTERISTICS (25 °C, unless otherwise noted)

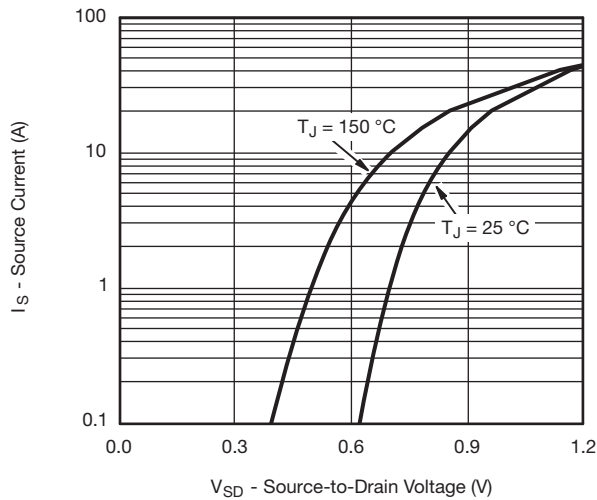

Source-Drain Diode Forward Voltage

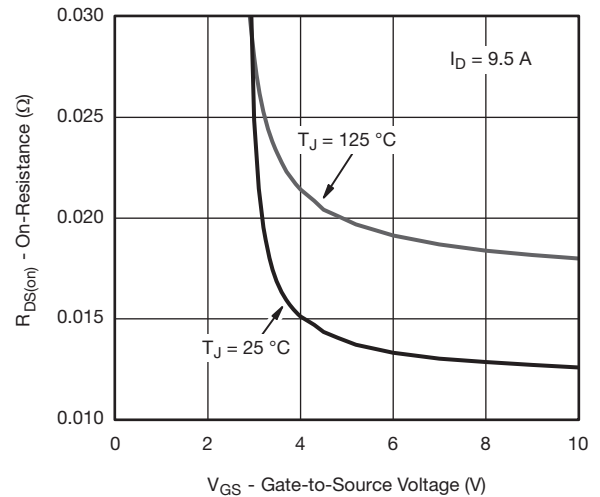

On-Resistance vs. Gate-to-Source Voltage

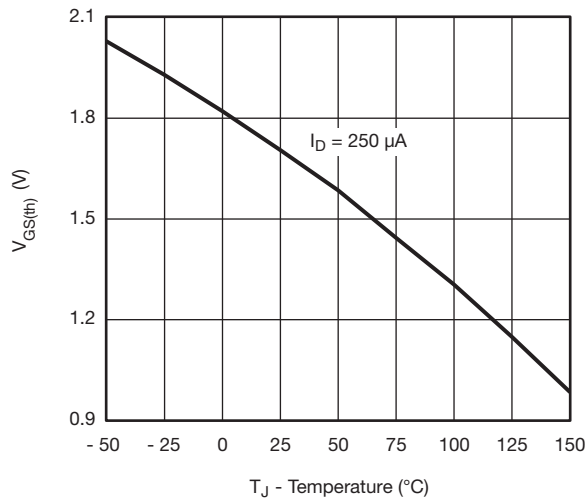

Threshold Voltage

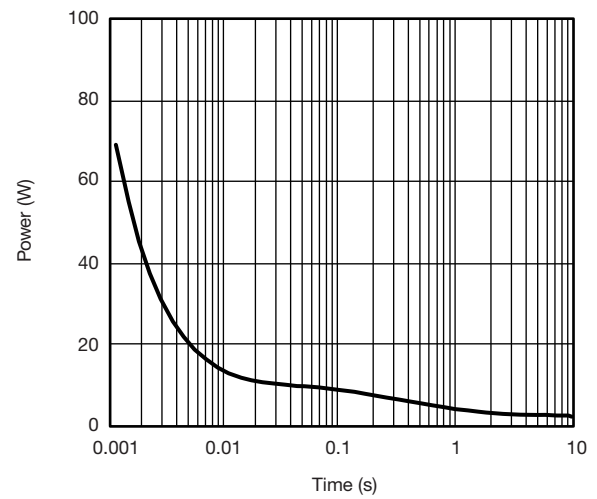

Single Pulse Power, Junction-to-Ambient

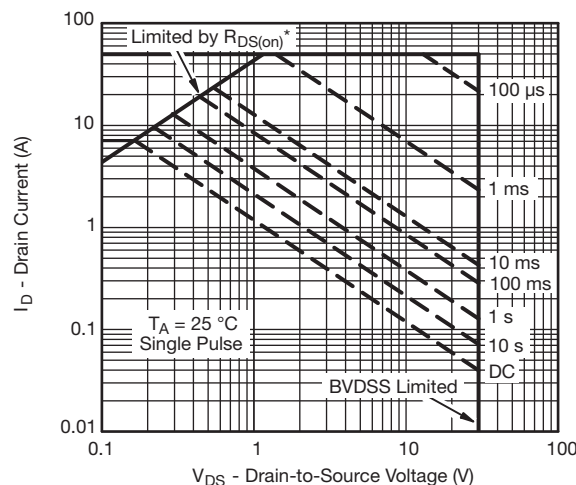

Safe Operating Area, Junction-to-Ambient

CHANNEL-1 TYPICAL CHARACTERISTICS (25 °C, unless otherwise noted)

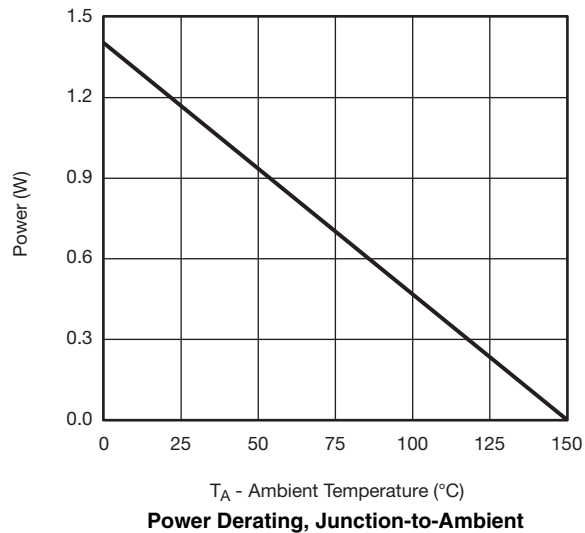
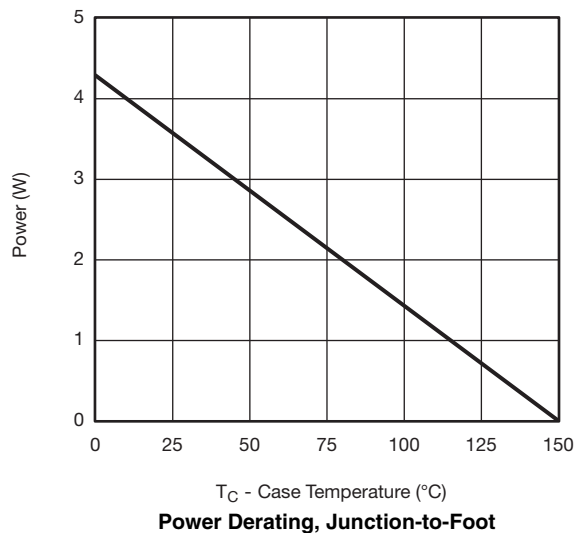
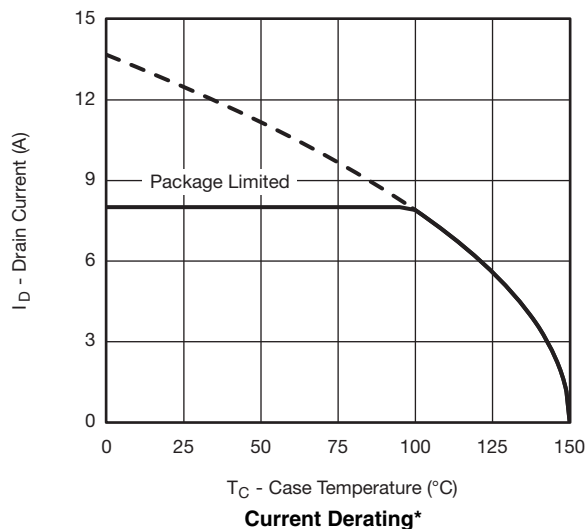

* The power dissipation P_D is based on $T_{J(max)} = 150$ °C, using junction-to-case thermal resistance, and is more useful in settling the upper dissipation limit for cases where additional heatsinking is used. It is used to determine the current rating, when this rating falls below the package limit.

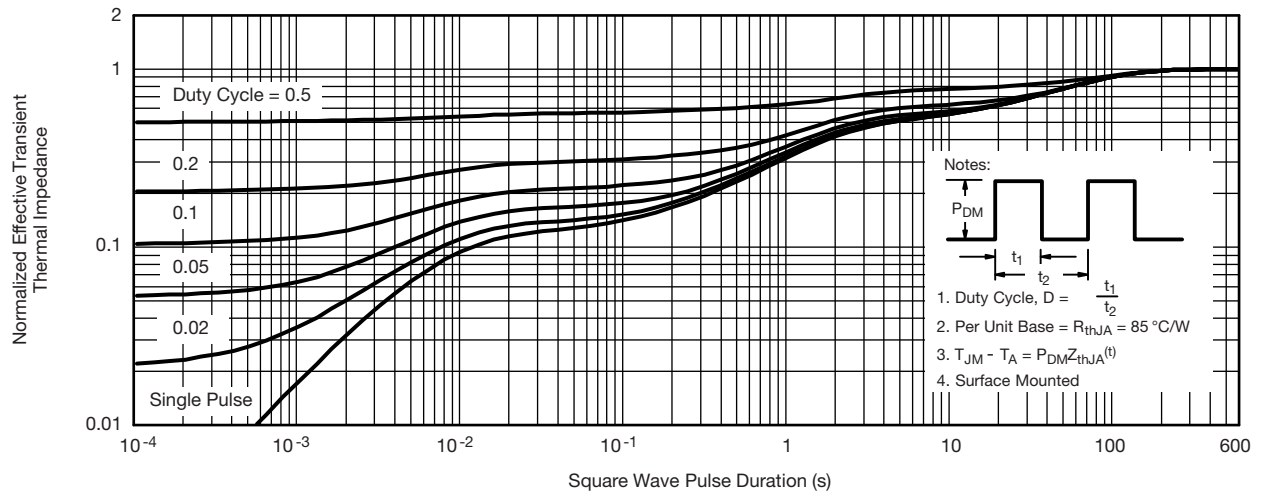
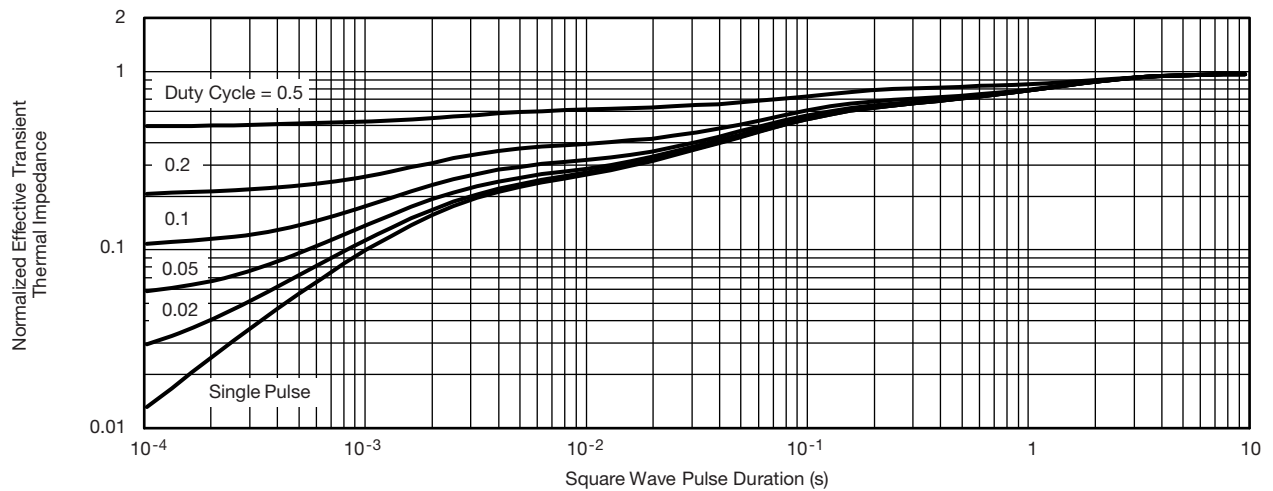
CHANNEL-1 TYPICAL CHARACTERISTICS (25 °C, unless otherwise noted)

Normalized Thermal Transient Impedance, Junction-to-Ambient

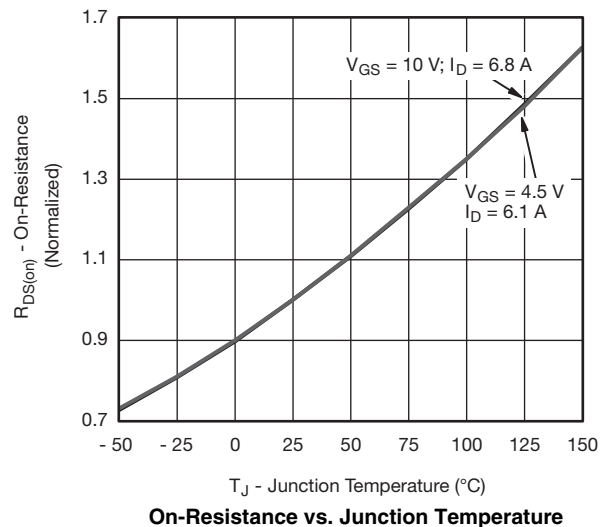
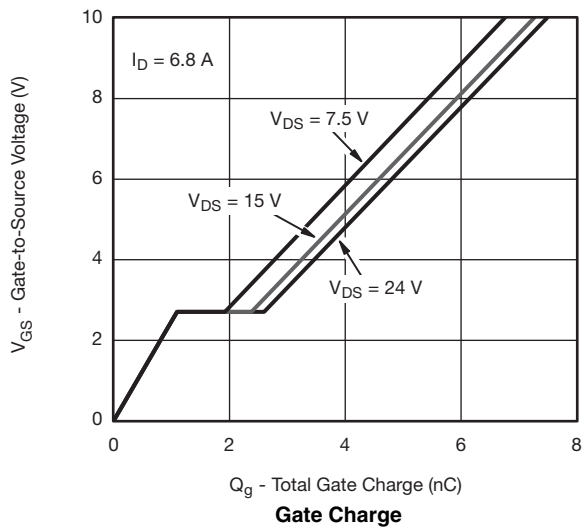
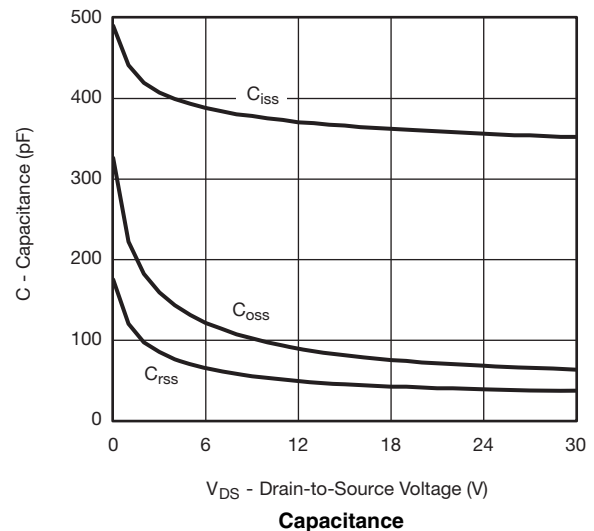
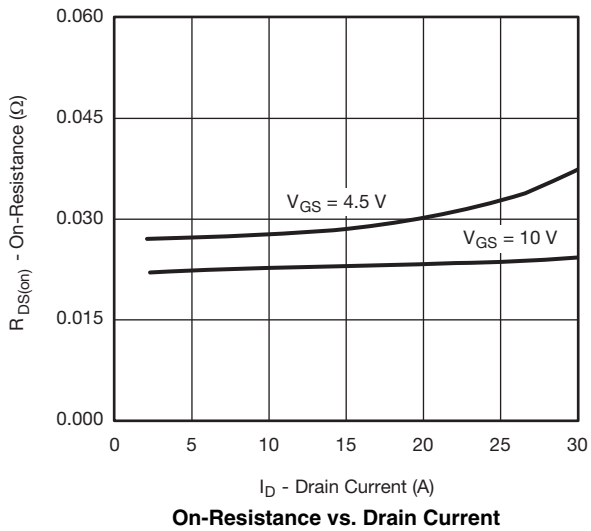
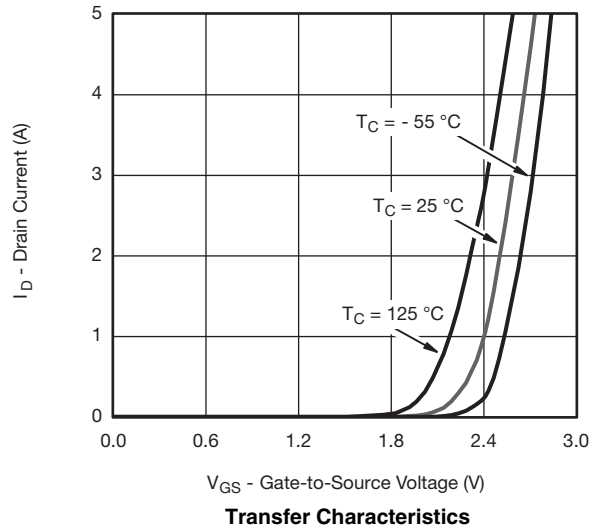
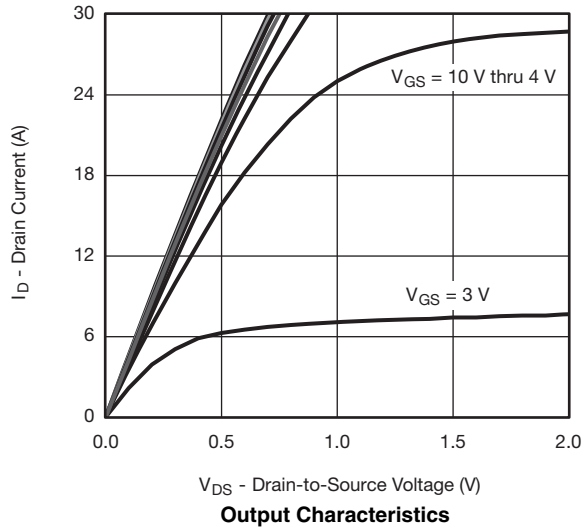
Normalized Thermal Transient Impedance, Junction-to-Foot

CHANNEL-2 TYPICAL CHARACTERISTICS (25 °C, unless otherwise noted)

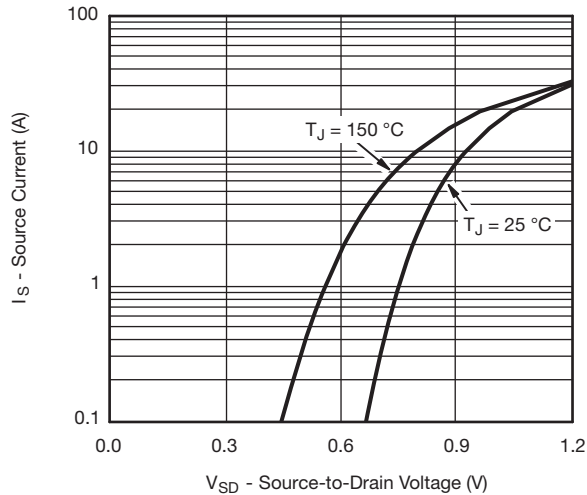

CHANNEL-2 TYPICAL CHARACTERISTICS (25 °C, unless otherwise noted)



Source-Drain Diode Forward Voltage

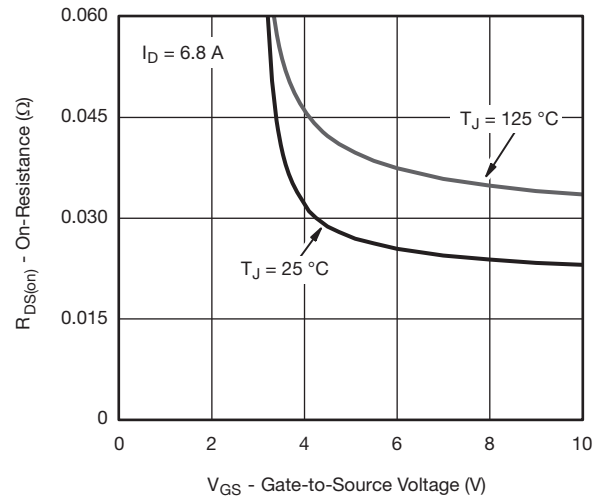

On-Resistance vs. Gate-to-Source Voltage

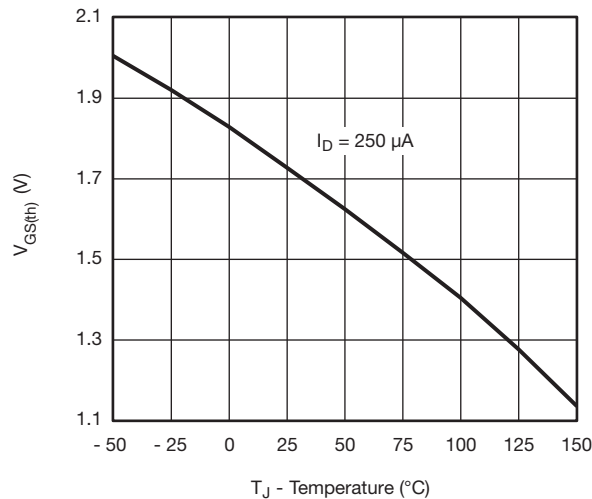

Threshold Voltage

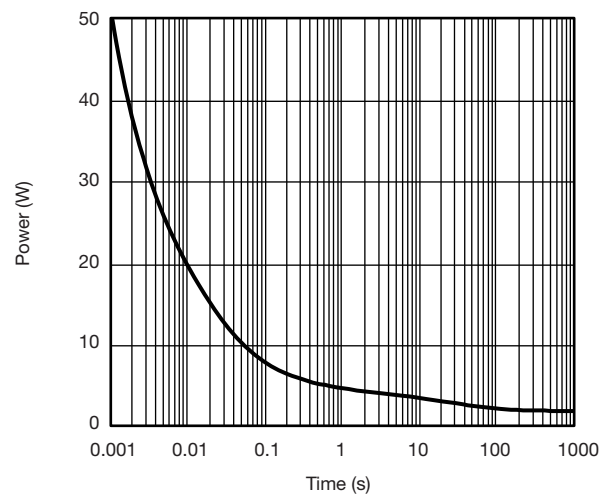

Single Pulse Power, Junction-to-Ambient

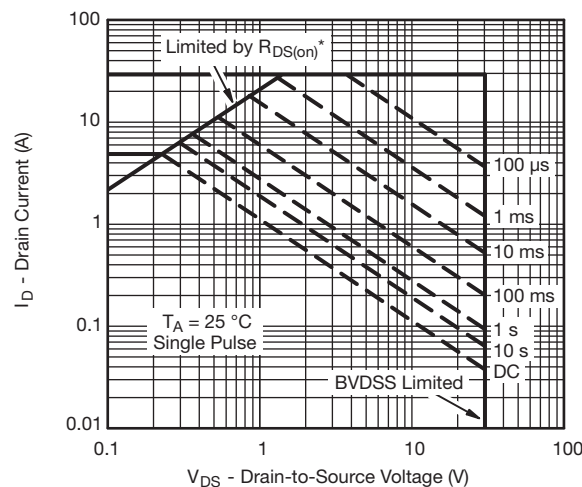

* $V_{GS} >$ minimum V_{GS} at which $R_{DS(on)}$ is specified

Safe Operating Area, Junction-to-Ambient

CHANNEL-2 TYPICAL CHARACTERISTICS (25 °C, unless otherwise noted)

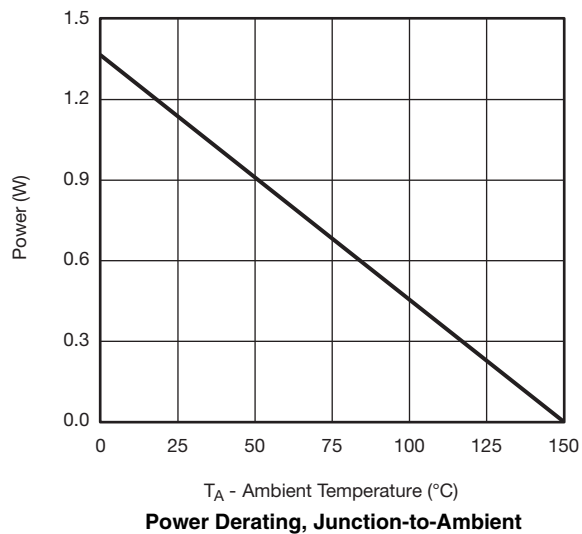
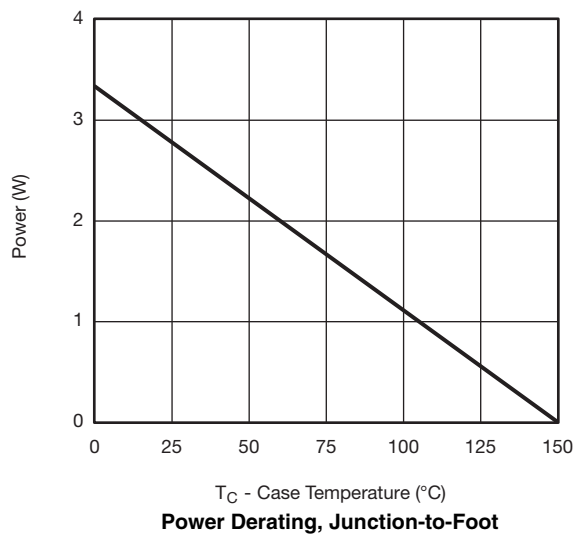
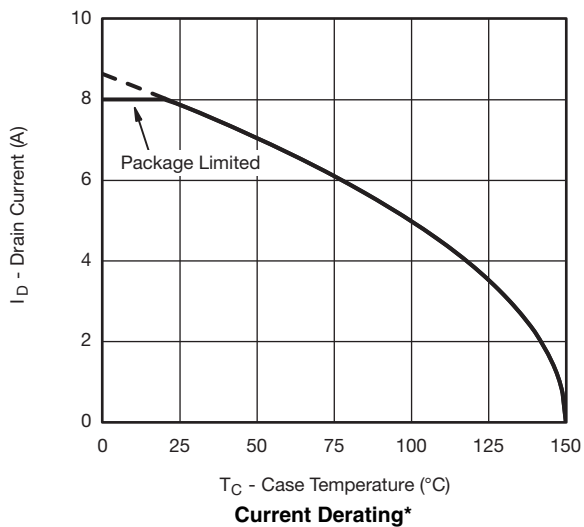

* The power dissipation P_D is based on $T_{J(max)} = 150\text{ °C}$, using junction-to-case thermal resistance, and is more useful in settling the upper dissipation limit for cases where additional heatsinking is used. It is used to determine the current rating, when this rating falls below the package limit.

CHANNEL-2 TYPICAL CHARACTERISTICS (25 °C, unless otherwise noted)

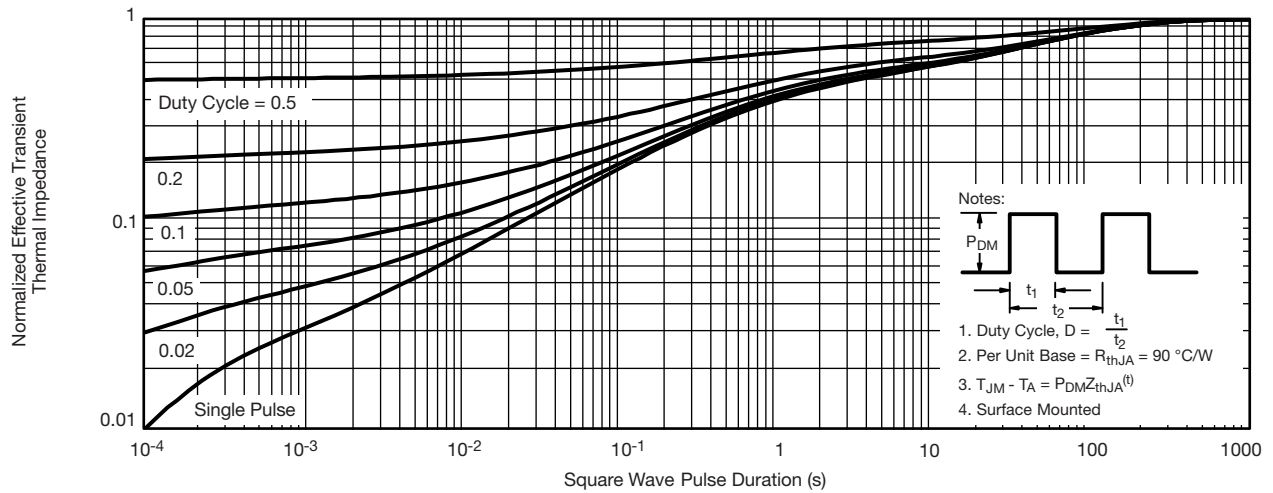

Normalized Thermal Transient Impedance, Junction-to-Ambient

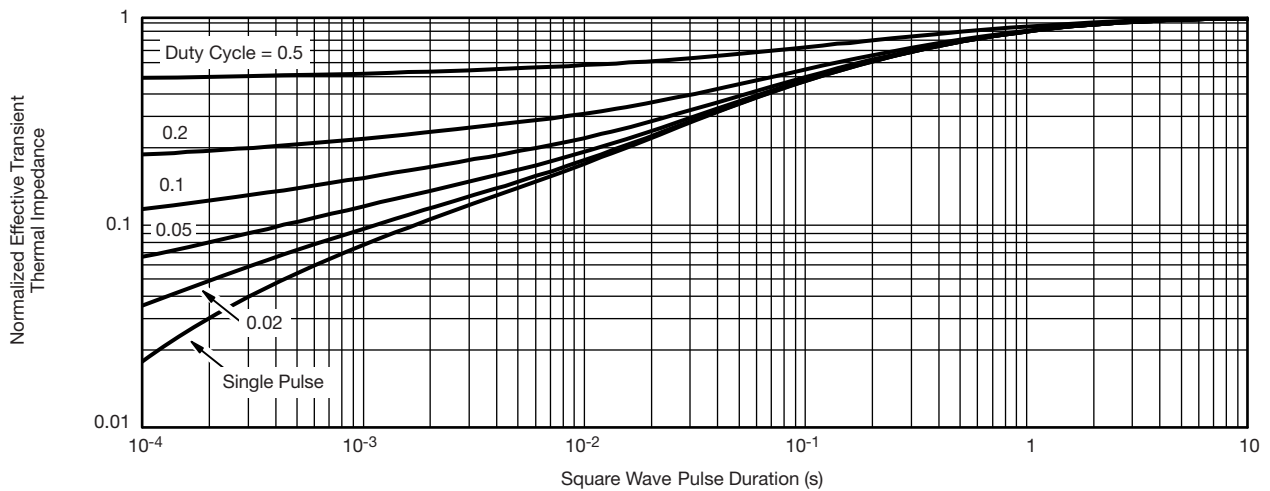

Normalized Thermal Transient Impedance, Junction-to-Foot

Vishay Siliconix maintains worldwide manufacturing capability. Products may be manufactured at one of several qualified locations. Reliability data for Silicon Technology and Package Reliability represent a composite of all qualified locations.

SOIC (NARROW): 8-LEAD

JEDEC Part Number: MS-012

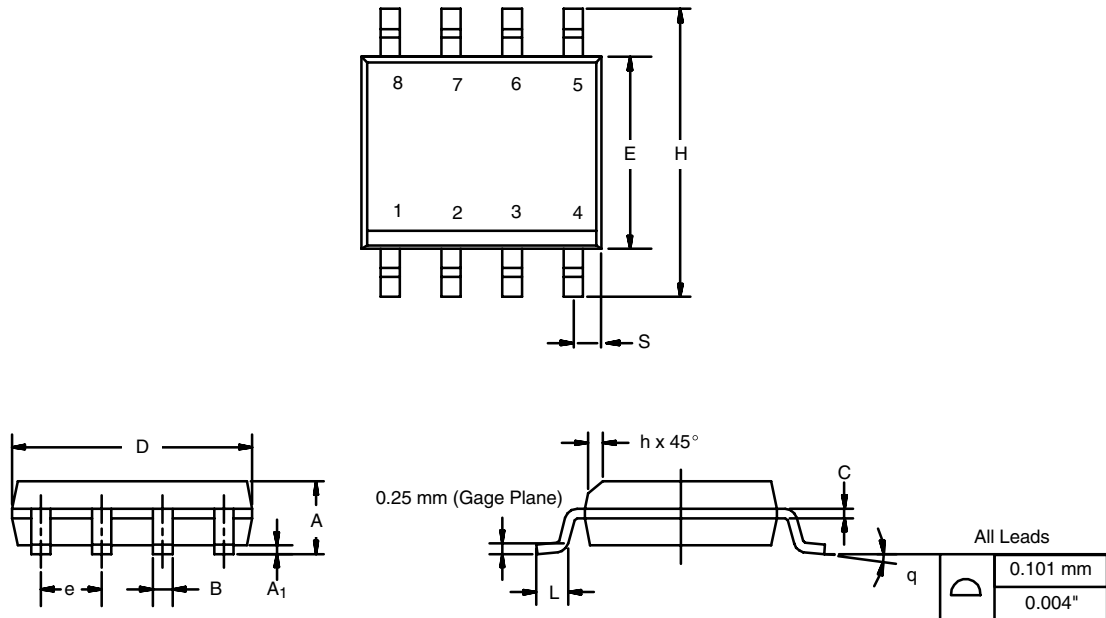

DIM	MILLIMETERS		INCHES	
	Min	Max	Min	Max
A	1.35	1.75	0.053	0.069
A ₁	0.10	0.20	0.004	0.008
B	0.35	0.51	0.014	0.020
C	0.19	0.25	0.0075	0.010
D	4.80	5.00	0.189	0.196
E	3.80	4.00	0.150	0.157
e	1.27 BSC		0.050 BSC	
H	5.80	6.20	0.228	0.244
h	0.25	0.50	0.010	0.020
L	0.50	0.93	0.020	0.037
q	0°	8°	0°	8°
S	0.44	0.64	0.018	0.026
ECN: C-06527-Rev. I, 11-Sep-06				
DWG: 5498				

RECOMMENDED MINIMUM PADS FOR SO-8



Recommended Minimum Pads
Dimensions in Inches/(mm)

[Return to Index](#)



Disclaimer

ALL PRODUCT, PRODUCT SPECIFICATIONS AND DATA ARE SUBJECT TO CHANGE WITHOUT NOTICE TO IMPROVE RELIABILITY, FUNCTION OR DESIGN OR OTHERWISE.

Vishay Intertechnology, Inc., its affiliates, agents, and employees, and all persons acting on its or their behalf (collectively, "Vishay"), disclaim any and all liability for any errors, inaccuracies or incompleteness contained in any datasheet or in any other disclosure relating to any product.

Vishay makes no warranty, representation or guarantee regarding the suitability of the products for any particular purpose or the continuing production of any product. To the maximum extent permitted by applicable law, Vishay disclaims (i) any and all liability arising out of the application or use of any product, (ii) any and all liability, including without limitation special, consequential or incidental damages, and (iii) any and all implied warranties, including warranties of fitness for particular purpose, non-infringement and merchantability.

Statements regarding the suitability of products for certain types of applications are based on Vishay's knowledge of typical requirements that are often placed on Vishay products in generic applications. Such statements are not binding statements about the suitability of products for a particular application. It is the customer's responsibility to validate that a particular product with the properties described in the product specification is suitable for use in a particular application. Parameters provided in datasheets and / or specifications may vary in different applications and performance may vary over time. All operating parameters, including typical parameters, must be validated for each customer application by the customer's technical experts. Product specifications do not expand or otherwise modify Vishay's terms and conditions of purchase, including but not limited to the warranty expressed therein.

Except as expressly indicated in writing, Vishay products are not designed for use in medical, life-saving, or life-sustaining applications or for any other application in which the failure of the Vishay product could result in personal injury or death. Customers using or selling Vishay products not expressly indicated for use in such applications do so at their own risk. Please contact authorized Vishay personnel to obtain written terms and conditions regarding products designed for such applications.

No license, express or implied, by estoppel or otherwise, to any intellectual property rights is granted by this document or by any conduct of Vishay. Product names and markings noted herein may be trademarks of their respective owners.