

**SCR/Diode
POW-R-BLOK™ Modules
90 Amperes/1200-1600 Volts**

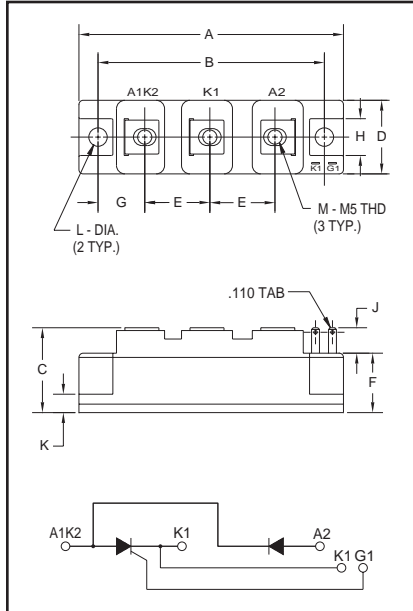

Outline Drawing

| Dimension | Inches | Millimeters |
|-----------|------------|-------------|
| A | 3.681 Max. | 93.5 Max. |
| B | 3.150 | 80 |
| C | 1.181 Max. | 30 Max. |
| D | 1.024 Max. | 26 Max. |
| E | 0.906 | 23 |
| F | 0.827 | 21 |
| G | 0.650 | 16.5 |
| H | 0.512 | 13 |
| J | 0.354 | 9 |
| K | 0.256 | 6.5 |
| L | 0.256 Dia. | Dia. 6.5 |
| M | M5 Metric | M5 |



**CM421290, CM421690
SCR/Diode
POW-R-BLOK™ Modules
90 Amperes/1200-1600 Volts**

Description:

Powerex SCR/Diode POW-R-BLOK™ Modules are designed for use in applications requiring Half-Control and isolated packaging. The modules are isolated for easy mounting with other components on common heatsinks.

Features:

- Isolated Mounting
- Glass Passivated Chips
- Metal Baseplate
- Low Thermal Impedance

Applications:

- Battery Supplies
- Bridge Circuits
- AC and DC Motor Control
- Tap Changers
- Lighting Control

Ordering Information:

Select the complete eight digit module part number you desire from the table below. Example: CM421290 is a 1200 Volt, 90 Ampere SCR/Diode POW-R-BLOK™ Module.

| Type | Voltage Volts (x100) | Current Rating Amperes (90) |
|------|-------------------------|--------------------------------|
| CM42 | 12 16 | 90 |



Powerex, Inc., 200 Hillis Street, Youngwood, Pennsylvania 15697-1800 (724) 925-7272

CM421290, CM421690
SCR/Diode POW-R-BLOK™ Modules
90 Amperes/1200-1600 Volts

Absolute Maximum Ratings

| Characteristics | Symbol | CM421290 | CM421690 | Units |
|--|------------------------------------|------------|------------|------------------------|
| Peak Forward Blocking Voltage | V_{DRM} | 1200 | 1600 | Volts |
| Transient Peak Forward Blocking Voltage (Non-Repetitive), $t < 5\text{ms}$ | V_{DSM} | 1350 | 1700 | Volts |
| DC Forward Blocking Voltage | $V_{D(DC)}$ | 960 | 1280 | Volts |
| Peak Reverse Blocking Voltage | V_{RRM} | 1200 | 1600 | Volts |
| Transient Peak Reverse Blocking Voltage (Non-Repetitive), $t < 5\text{ms}$ | V_{RSM} | 1350 | 1700 | Volts |
| DC Reverse Blocking Voltage | $V_{R(DC)}$ | 960 | 1280 | Volts |
| RMS On-State Current | $I_T(\text{RMS}), I_F(\text{RMS})$ | 140 | 140 | Amperes |
| Average On-State Current, $T_C = 82^\circ\text{C}$ | $I_T(\text{AV}), I_F(\text{AV})$ | 90 | 90 | Amperes |
| Peak One-Cycle Surge (Non-Repetitive) On-State Current (60Hz) | I_{TSM}, I_{FSM} | 1800 | 1800 | Amperes |
| Peak One-Cycle Surge (Non-Repetitive) On-State Current (50Hz) | I_{TSM}, I_{FSM} | 1730 | 1730 | Amperes |
| I^2t (for Fusing), 8.3 milliseconds | I^2t | 15000 | 15000 | A^2sec |
| Critical Rate-of-Rise of On-State Current* | di/dt | 100 | 100 | Amperes/ μs |
| Peak Gate Power Dissipation | P_{GM} | 5.0 | 5.0 | Watts |
| Average Gate Power Dissipation | $P_{G(\text{AV})}$ | 0.5 | 0.5 | Watts |
| Peak Forward Gate Voltage | V_{GFM} | 10 | 10 | Volts |
| Peak Reverse Gate Voltage | V_{GRM} | 5.0 | 5.0 | Volts |
| Peak Forward Gate Current | I_{GFM} | 2.0 | 2.0 | Amperes |
| Storage Temperature | T_{STG} | -40 to 125 | -40 to 125 | $^\circ\text{C}$ |
| Operating Temperature | T_j | -40 to 125 | -40 to 125 | $^\circ\text{C}$ |
| Maximum Mounting Torque M6 Mounting Screw | — | 26 | 26 | in.-lb. |
| Maximum Mounting Torque M5 Terminal Screw | — | 17 | 17 | in.-lb. |
| Module Weight (Typical) | — | 160 | 160 | Grams |
| V Isolation | V_{RMS} | 2500 | 2500 | Volts |

* $T_j = 125^\circ\text{C}$, $I_G = 1.0\text{A}$, $V_D = 1/2 V_{DRM}$

Electrical and Thermal Characteristics, $T_j = 25^\circ\text{C}$ unless otherwise specified

| Characteristics | Symbol | Test Conditions | CM421290/CM421690 | Units |
|---|-------------------|--|-------------------|------------------------------|
| Blocking State Maximums | | | | |
| Forward Leakage Current, Peak | I_{DRM} | $T_j = 125^\circ\text{C}$, $V_{DRM} = \text{Rated}$ | 15 | mA |
| Reverse Leakage Current, Peak | I_{RRM} | $T_j = 125^\circ\text{C}$, $V_{RRM} = \text{Rated}$ | 15 | mA |
| Conducting State Maximums | | | | |
| Peak On-State Voltage | V_{FM}, V_{TM} | $I_{FM} = 270\text{A}$, $I_{TM} = 270\text{A}$ | 1.4 | Volts |
| Switching Minimums | | | | |
| Critical Rate-of-Rise of Off-State Voltage | dv/dt | $T_j = 125^\circ\text{C}$, $V_D = 2/3 V_{DRM}$ | 500 | Volts/ μs |
| Thermal Maximums | | | | |
| Thermal Resistance, Junction-to-Case | $R_{\theta(J-C)}$ | Per Module | 0.3 | $^\circ\text{C}/\text{Watt}$ |
| Thermal Resistance, Case-to-Sink (Lubricated) | $R_{\theta(C-S)}$ | Per Module | 0.2 | $^\circ\text{C}/\text{Watt}$ |
| Gate Parameters Maximums | | | | |
| Gate Current-to-Trigger | I_{GT} | $V_D = 6\text{V}$, $R_L = 2\Omega$ | 100 | mA |
| Gate Voltage-to-Trigger | V_{GT} | $V_D = 6\text{V}$, $R_L = 2\Omega$ | 2.0 | Volts |
| Non-Triggering Gate Voltage | V_{GDM} | $T_j = 125^\circ\text{C}$, $V_D = 1/2 V_{DRM}$ | 0.25 | Volts |

CM421290, CM421690
SCR/Diode POW-R-BLOK™ Modules
 90 Amperes/1200-1600 Volts

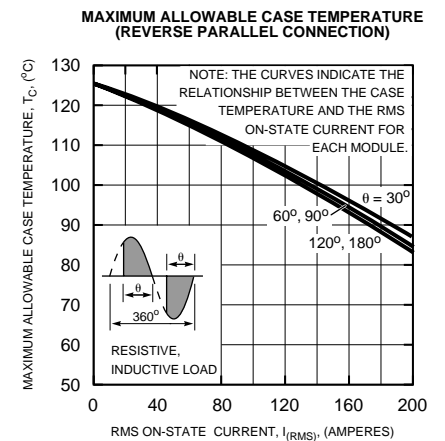
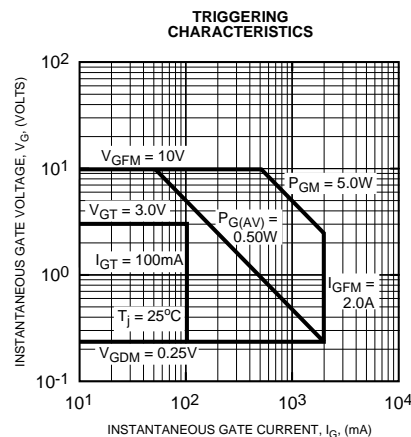
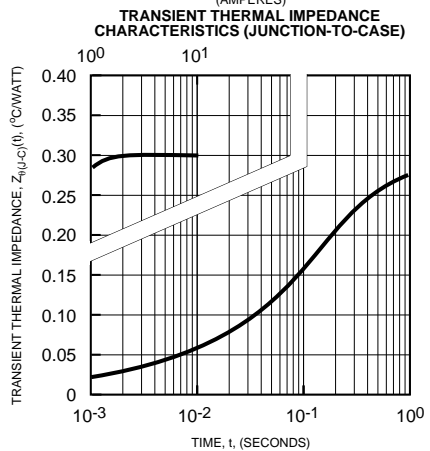
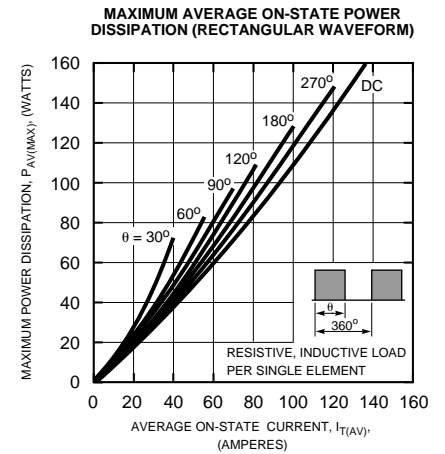
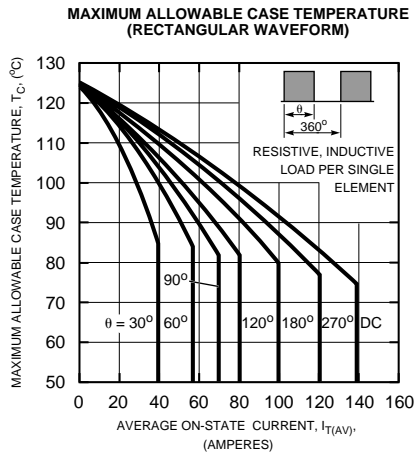
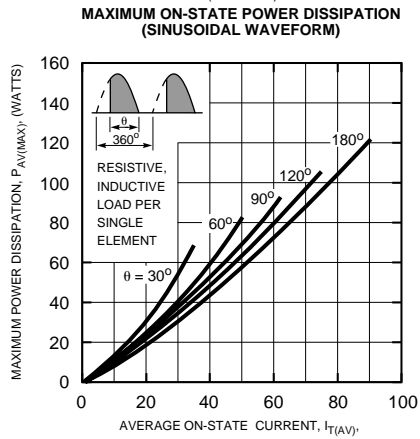
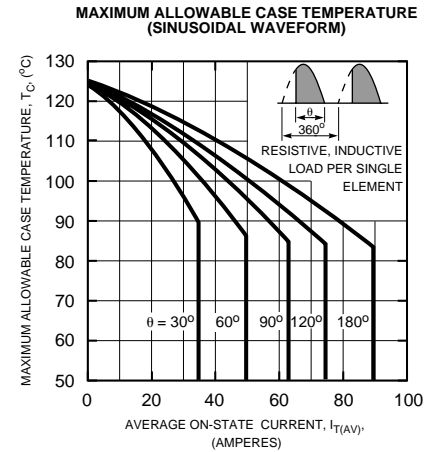
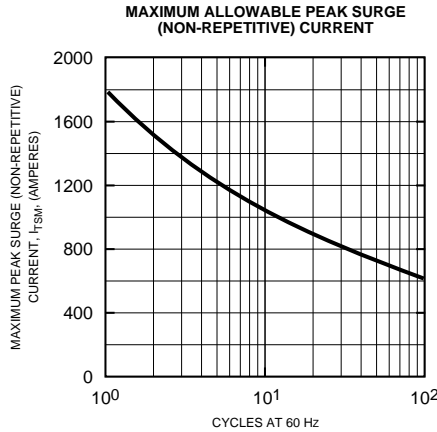
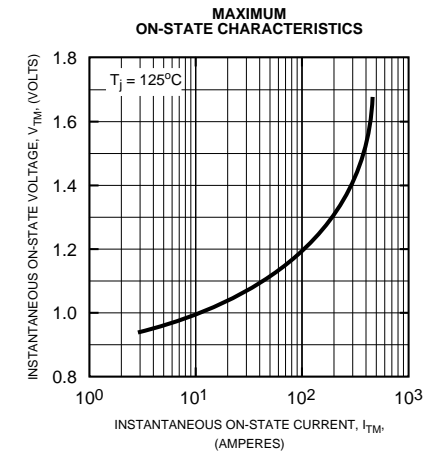

CM421290, CM421690
SCR/Diode POW-R-BLOK™ Modules
 90 Amperes/1200-1600 Volts

MAXIMUM ON-STATE POWER DISSIPATION (REVERSE PARALLEL CONNECTION)

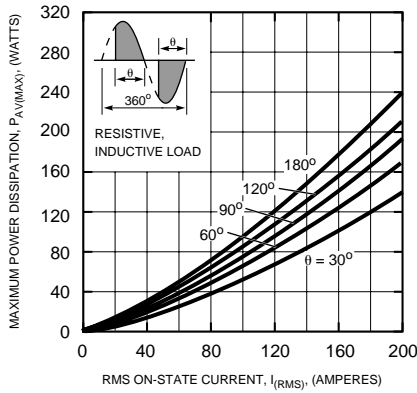

NOTE: THE CURVES INDICATE THE RELATIONSHIP BETWEEN THE AVERAGE ON-STATE POWER DISSIPATION PER MODULE AND THE RMS ON-STATE CURRENT.

MAXIMUM ALLOWABLE CASE TEMPERATURE (SINGLE PHASE BRIDGE CONNECTION)

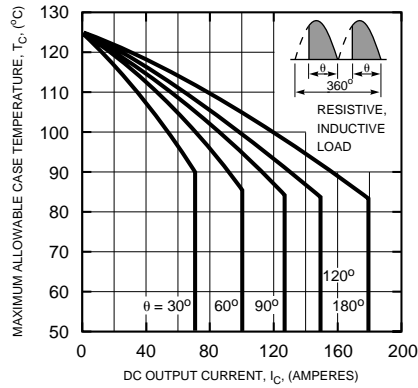

NOTE: THE CURVES INDICATE THE RELATIONSHIP BETWEEN THE CASE TEMPERATURE AND THE DC OUTPUT CURRENT (FOR TWO ELEMENTS) WHEN USED IN THE SINGLE PHASE BRIDGE CONFIGURATION.

MAXIMUM ON-STATE POWER DISSIPATION (SINGLE PHASE BRIDGE CONNECTION)

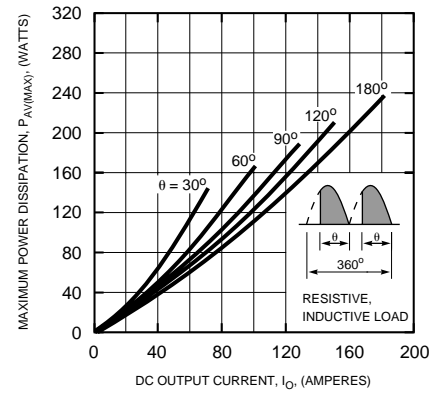

NOTE: THE CURVES INDICATE THE RELATIONSHIP BETWEEN THE AVERAGE ON-STATE POWER DISSIPATION AND THE DC OUTPUT CURRENT FOR THE SINGLE PHASE BRIDGE CONFIGURATION (POWER DISSIPATION EXPRESSED FOR EACH MODULE AND DC OUTPUT CURRENT EXPRESSED FOR THE PAIR)

MAXIMUM ALLOWABLE CASE TEMPERATURE (THREE PHASE BRIDGE CONNECTION)

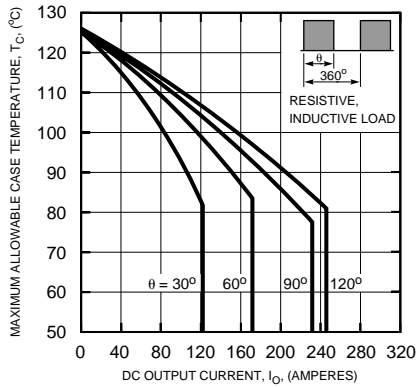

NOTE: THE CURVES INDICATE THE RELATIONSHIP BETWEEN THE CASE TEMPERATURE AND THE DC OUTPUT CURRENT (FOR THREE MODULES) IN THE THREE PHASE CONFIGURATION.

MAXIMUM ON-STATE POWER DISSIPATION (THREE PHASE BRIDGE CONNECTION)

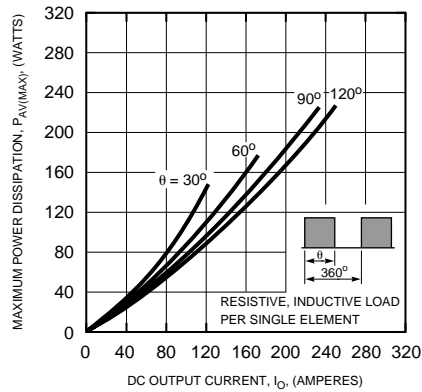

NOTE: THE CURVES INDICATE THE RELATIONSHIP BETWEEN THE ON-STATE POWER DISSIPATION (PER MODULE) AND THE DC OUTPUT CURRENT (FOR THREE MODULES) IN THE THREE PHASE BRIDGE CONFIGURATION.