

### FEATURES

**Dual 10-bit, 40 MSPS, 65 MSPS, 80 MSPS, and 105 MSPS ADC**  
**Low power: 275 mW at 105 MSPS per channel**  
**On-chip reference and track-and-hold**  
**300 MHz analog bandwidth each channel**  
**SNR = 57 dB @ 41 MHz, Encode = 80 MSPS**  
**1 V p-p or 2 V p-p analog input range each channel**  
**3.0 V single-supply operation (2.7 V to 3.6 V)**  
**Power-down mode for single-channel operation**  
**Twos complement or offset binary output mode**  
**Output data alignment mode**  
**Pin compatible with the 8-bit AD9288**  
**-75 dBc crosstalk between channels**

### APPLICATIONS

**Battery-powered instruments**  
**Hand-held scopemeters**  
**Low cost digital oscilloscopes**  
**I and Q communications**  
**Ultrasound equipment**

### GENERAL DESCRIPTION

The AD9218 is a dual 10-bit monolithic sampling analog-to-digital converter with on-chip track-and-hold circuits. The product is low cost, low power, and is small and easy to use. The AD9218 operates at a 105 MSPS conversion rate with outstanding dynamic performance over its full operating range. Each channel can be operated independently.

The ADC requires only a single 3.0 V (2.7 V to 3.6 V) power supply and a clock for full operation. No external reference or driver components are required for many applications. The digital outputs are TTL/CMOS compatible and a separate output power supply pin supports interfacing with 3.3 V or 2.5 V logic.

The clock input is TTL/CMOS compatible and the 10-bit digital outputs can be operated from 3.0 V (2.5 V to 3.6 V) supplies. User-selectable options offer a combination of power-down modes, digital data formats, and digital data timing schemes. In power-down mode, the digital outputs are driven to a high impedance state.

### FUNCTIONAL BLOCK DIAGRAM

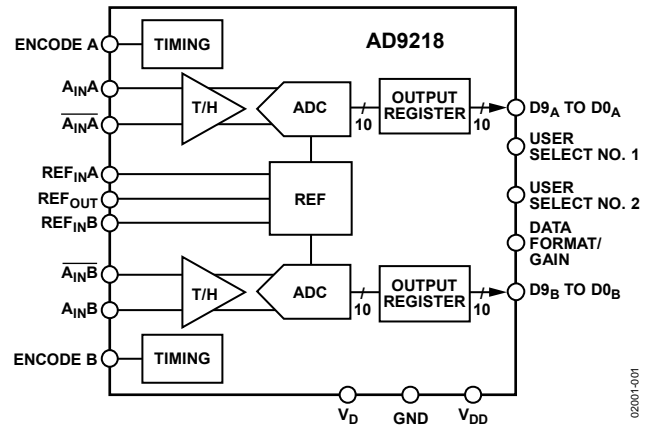

Figure 1.

### PRODUCT HIGHLIGHTS

1. **Low Power.** Only 275 mW power dissipation per channel at 105 MSPS. Other speed grades proportionally scaled down while maintaining high ac performance.
2. **Pin Compatibility Upgrade.** Allows easy migration from 8-bit to 10-bit devices. Pin compatible with the 8-bit AD9288 dual ADC.
3. **Easy to Use.** On-chip reference and user controls provide flexibility in system design.
4. **High Performance.** Maintains 54 dB SNR at 105 MSPS with a Nyquist input.
5. **Channel Crosstalk.** Very low at -75 dBc.
6. **Fabricated on an Advanced CMOS Process.** Available in a 48-lead low profile quad flat package (7 mm × 7 mm LQFP) specified over the industrial temperature range (-40°C to +85°C).

#### Rev. C

Information furnished by Analog Devices is believed to be accurate and reliable. However, no responsibility is assumed by Analog Devices for its use, nor for any infringements of patents or other rights of third parties that may result from its use. Specifications subject to change without notice. No license is granted by implication or otherwise under any patent or patent rights of Analog Devices. Trademarks and registered trademarks are the property of their respective owners.

# AD9218\* PRODUCT PAGE QUICK LINKS

Last Content Update: 02/23/2017

---

## COMPARABLE PARTS

View a parametric search of comparable parts.

## DOCUMENTATION

### Application Notes

- AN-282: Fundamentals of Sampled Data Systems
- AN-345: Grounding for Low-and-High-Frequency Circuits
- AN-501: Aperture Uncertainty and ADC System Performance
- AN-715: A First Approach to IBIS Models: What They Are and How They Are Generated
- AN-737: How ADIsimADC Models an ADC
- AN-741: Little Known Characteristics of Phase Noise
- AN-756: Sampled Systems and the Effects of Clock Phase Noise and Jitter
- AN-835: Understanding High Speed ADC Testing and Evaluation
- AN-905: Visual Analog Converter Evaluation Tool Version 1.0 User Manual
- AN-935: Designing an ADC Transformer-Coupled Front End

### Data Sheet

- AD9218: 10-Bit, 40/65/80/105 MSPS 3 V Dual Analog-to-Digital Converter Data Sheet

## TOOLS AND SIMULATIONS

- Visual Analog
- AD9218 IBIS Models

## REFERENCE MATERIALS

### Technical Articles

- Correlating High-Speed ADC Performance to Multicarrier 3G Requirements
- DNL and Some of its Effects on Converter Performance
- MS-2210: Designing Power Supplies for High Speed ADC
- Single Chip Realizes Direct-Conversion Rx

## DESIGN RESOURCES

- AD9218 Material Declaration
- PCN-PDN Information
- Quality And Reliability
- Symbols and Footprints

## DISCUSSIONS

View all AD9218 EngineerZone Discussions.

## SAMPLE AND BUY

Visit the product page to see pricing options.

## TECHNICAL SUPPORT

Submit a technical question or find your regional support number.

## DOCUMENT FEEDBACK

Submit feedback for this data sheet.

## TABLE OF CONTENTS

Features .....	1	Using the AD9218 ENCODE Input.....	18
Applications.....	1	Digital Outputs .....	18
Functional Block Diagram .....	1	Analog Input .....	18
General Description .....	1	Voltage Reference .....	19
Product Highlights .....	1	Timing .....	19
Revision History .....	2	User Select Options.....	19
Specifications.....	3	Application Information .....	19
DC Specifications .....	3	AD9218/AD9288 Customer PCB BOM.....	20
Digital Specifications .....	4	Evaluation Board .....	21
AC Specifications.....	5	Power Connector.....	21
Switching Specifications .....	6	Analog Inputs .....	21
Timing Diagrams.....	6	Voltage Reference .....	21
Absolute Maximum Ratings.....	8	Clocking.....	21
Explanation of Test Levels.....	8	Data Outputs.....	21
ESD Caution.....	8	Data Format/Gain .....	21
Pin Configuration and Function Descriptions.....	9	Timing .....	21
Terminology .....	10	Troubleshooting.....	21
Equivalent Circuits .....	12	Outline Dimensions .....	25
Typical Performance Characteristics .....	13	Ordering Guide .....	25
Theory of Operation .....	18		

## REVISION HISTORY

### 12/06—Rev. B to Rev. C

Updated Format.....	Universal
Changes to DC Specifications.....	3

### 1/04—Rev. A. to Rev. B

Updated format.....	Universal
Changes to General Description .....	1
Changes to DC Specifications.....	3
Changes to Switching Specifications.....	6
Added AD9218/AD9288 Customer PCB BOM section .....	20
Added Evaluation Board section .....	21

### 7/03—Rev. 0 to Rev. A

Updated Ordering Guide.....	6
Changes to Terminology section .....	8
Changes to Figure 17b.....	19
Updated Outline Dimensions .....	24

# SPECIFICATIONS

## DC SPECIFICATIONS

$V_{DD} = 3.0\text{ V}$ ,  $V_D = 3.0\text{ V}$ ; external reference, unless otherwise noted.

Table 1.

Parameter	Temp	Test Level	AD9218BST-40/-65			AD9218BST-80/-105			Unit
			Min	Typ	Max	Min	Typ	Max	
RESOLUTION			10			10			Bits
ACCURACY			Guaranteed, not tested			Guaranteed, not tested			
No Missing Codes <sup>1</sup>	Full	VI	Guaranteed, not tested			Guaranteed, not tested			
Offset Error <sup>2</sup>	25°C	I	-18	2	18	-18	2	18	LSB
Gain Error <sup>2</sup>	25°C	I	-2	3	8	-2	3.5	8	% FS
Differential Nonlinearity (DNL)	25°C	I	-1	$\pm 0.3/\pm 0.6$	1/1.3	-1	$\pm 0.5/\pm 0.8$	1.2/1.7	LSB
Integral Nonlinearity (INL)	Full	VI	$\pm 0.8$			$\pm 0.6/\pm 0.9$			LSB
	25°C	I	-1/-1.6	$\pm 0.3/\pm 1$	1/1.6	-1.35/-2.7	$\pm 0.75/\pm 2$	+1.35/2.7	LSB
	Full	VI	$\pm 1$			$\pm 1/\pm 2.3$			LSB
TEMPERATURE DRIFT									
Offset Error	Full	V	10			4			ppm/°C
Gain Error <sup>2</sup>	Full	V	80			100			ppm/°C
Reference	Full	V	40			40			ppm/°C
REFERENCE									
Internal Reference Voltage (REF <sub>OUT</sub> )	25°C	I	1.18	1.24	1.28	1.18	1.24	1.28	V
Input Resistance (REF <sub>IN</sub> A, REF <sub>IN</sub> B)	Full	VI	9	11	13	9	11	13	kΩ
ANALOG INPUTS									
Differential Input Voltage Range ( $A_{IN}$ , $\overline{A_{IN}}$ ) <sup>3</sup>	Full	V	1 or 2			1			V
Common-Mode Voltage <sup>3</sup>	Full	V	$V_D/3$			$V_D/3$			V
Input Resistance	Full	VI	8	10	14	8	10	14	kΩ
Input Capacitance	25°C	V	3			3			pF
POWER SUPPLY									
$V_D$	Full	IV	2.7	3	3.6	2.7	3	3.6	V
$V_{DD}$	Full	IV	2.7	3	3.6	2.7	3	3.6	V
Supply Currents									
$I_{V_D}$ ( $V_D = 3.0\text{ V}$ ) <sup>4</sup>	Full	VI	108/117		113/130	172/183		175/188	mA
$I_{V_{DD}}$ ( $V_{DD} = 3.0\text{ V}$ ) <sup>4</sup>	25°C	V	7/11			13/17			mA
Power Dissipation DC <sup>5</sup>	Full	VI	325/350		340/390	515/550		525/565	mW
$I_{V_D}$ Power-Down Current <sup>6</sup>	Full	VI	20			22			mA
Power Supply Rejection Ratio	25°C	I	$\pm 1$			$\pm 1$			mV/V

<sup>1</sup> No missing codes across industrial temperature range guaranteed for 40 MSPS, 65 MSPS, and 80 MSPS grades. No missing codes at room temperature guaranteed for 105 MSPS grade.

<sup>2</sup> Gain error and gain temperature coefficients are based on the ADC only (with a fixed 1.25 V external reference) 65 grade in 2 V p-p range, 40, 80, 105 grades in 1 V p-p range.

<sup>3</sup>  $(A_{IN} - \overline{A_{IN}}) = \pm 0.5\text{ V}$  in 1 V range (full scale),  $(A_{IN} - \overline{A_{IN}}) = \pm 1\text{ V}$  in 2 V range (full scale). The analog inputs self-bias to  $V_D/3$ . This common-mode voltage can be overdriven externally by a low impedance source by  $\pm 300\text{ mV}$  (differential drive, gain = 1) or  $\pm 150\text{ mV}$  (differential drive, gain = 2).

<sup>4</sup> AC power dissipation measured with rated encode and a 10.3 MHz analog input @ 0.5 dBFS,  $C_{LOAD} = 5\text{ pF}$ .

<sup>5</sup> DC power dissipation measured with rated encode and a dc analog input (outputs static,  $I_{V_{DD}} = 0$ ).

<sup>6</sup> In power-down state,  $I_{V_{DD}} = \pm 10\text{ }\mu\text{A}$  typical (all grades).

# AD9218

## DIGITAL SPECIFICATIONS

$V_{DD} = 3.0\text{ V}$ ,  $V_D = 3.0\text{ V}$ ; external reference, unless otherwise noted.

Table 2.

Parameter	Temp	Test Level	AD9218BST-40/-65			AD9218BST-80/-105			Unit
			Min	Typ	Max	Min	Typ	Max	
DIGITAL INPUTS									
Encode Input Common Mode	Full	V	$V_D/2$			$V_D/2$			V
Encode 1 Voltage	Full	VI	2			2			V
Encode 0 Voltage	Full	VI			0.8			0.8	V
Encode Input Resistance	Full	VI	1.8	2.0	2.3	1.8	2.0	2.3	k $\Omega$
Logic 1 Voltage—S1, S2, DFS	Full	VI	2			2			V
Logic 0 Voltage—S1, S2, DFS	Full	VI			0.8			0.8	V
Logic 1 Current—S1	Full	VI	-50	$\pm 0$	50	-50	$\pm 0$	50	$\mu\text{A}$
Logic 0 Current—S1	Full	VI	-400	-230	-50	-400	-230	-50	$\mu\text{A}$
Logic 1 Current—S2	Full	VI	50	230	400	50	230	400	$\mu\text{A}$
Logic 0 Current—S2	Full	VI	-50	$\pm 0$	50	-50	$\pm 0$	50	$\mu\text{A}$
Logic 1 Current—DFS	Full	VI	30	100	200	30	100	200	$\mu\text{A}$
Logic 0 Current—DFS	Full	VI	-400	-230	-50	-400	-230	-50	$\mu\text{A}$
Input Capacitance—S1, S2, Encode Inputs	25°C	V		2			2		pF
Input Capacitance DFS	25°C	V		4.5			4.5		pF
DIGITAL OUTPUTS									
Logic 1 Voltage	Full	VI	2.45			2.45			V
Logic 0 Voltage	Full	VI			0.05			0.05	V
Output Coding			Twos complement or offset binary			Twos complement or offset binary			

## AC SPECIFICATIONS

$V_{DD} = 3.0\text{ V}$ ,  $V_D = 3.0\text{ V}$ ; external reference, unless otherwise noted.

Table 3.

Parameter	Temp	Test Level	AD9218BST-40/-65			AD9218BST-80/-105			Unit
			Min	Typ	Max	Min	Typ	Max	
DYNAMIC PERFORMANCE <sup>1</sup>									
Signal-to-Noise Ratio (SNR) (Without Harmonics)									
$f_{IN} = 10.3\text{ MHz}$	25°C	I	58/55	59/57		57/53	58/55	dB	
$f_{IN} = \text{Nyquist}^2$	25°C	I	-/54	59/56		55/52	57/54	dB	
Signal-to-Noise and Distortion (SINAD) (With Harmonics)									
$f_{IN} = 10.3\text{ MHz}$	25°C	I	58/54	59/56		56/52	58/53	dB	
$f_{IN} = \text{Nyquist}^2$	25°C	I	-/53	59/55		55/51	57/53	dB	
Effective Number of Bits									
$f_{IN} = 10.3\text{ MHz}$	25°C	I	9.4/8.8	9.6/9.1		9.1/8.4	9.4/8.6	Bits	
$f_{IN} = \text{Nyquist}^2$	25°C	I	-/8.6	9.6/8.9		9/8.3	9.3/8.6	Bits	
Second Harmonic Distortion									
$f_{IN} = 10.3\text{ MHz}$	25°C	I	-72/-66	-89/-77		-69/-60	-77/-68	dBc	
$f_{IN} = \text{Nyquist}^2$	25°C	I	-/-63	-89/-72		-65/-57	-76/-66	dBc	
Third Harmonic Distortion									
$f_{IN} = 10.3\text{ MHz}$	25°C	I	-68/-62	-79/-68		-62/-57	-71/-63	dBc	
$f_{IN} = \text{Nyquist}^2$	25°C	I	-/-60	-78/-64		-63/-57	-73/-69	dBc	
Spurious Free Dynamic Range (SFDR)									
$f_{IN} = 10.3\text{ MHz}$	25°C	I	-68/-62	-79/-67		-62/-57	-69/-62	dBc	
$f_{IN} = \text{Nyquist}^2$	25°C	I	-/-60	-78/-64		-63/-57	-70/-63	dBc	
Two-Tone Intermodulation Distortion (IMD)									
$f_{IN1} = 10\text{ MHz}$ , $f_{IN2} = 11\text{ MHz}$ at -7 dBFS	25°C	V		-74/-73				dBc	
$f_{IN1} = 30\text{ MHz}$ , $f_{IN2} = 31\text{ MHz}$ at -7 dBFS	25°C	V		-73/-73			-77/-67	dBc	
Analog Bandwidth, Full Power	25°C	V		300			300	MHz	
Crosstalk	25°C	V		-75			-75	dBc	

<sup>1</sup> AC specifications based on an analog input voltage of -0.5 dBFS at 10.3 MHz, unless otherwise noted. AC specifications for 40, 80, 105 grades are tested in 1 V p-p range and driven differentially. AC specifications for 65 grade are tested in 2 V p-p range and driven differentially.

<sup>2</sup> The 65, 80, and 105 grades are tested close to Nyquist for that grade: 31 MHz, 39 MHz, and 51 MHz for the 65, 80, and 105 grades, respectively.

# AD9218

## SWITCHING SPECIFICATIONS

$V_{DD} = 3.0\text{ V}$ ,  $V_D = 3.0\text{ V}$ ; external reference, unless otherwise noted.

Table 4.

Parameter	Temp	Test Level	AD9218BST-40/-65			AD9218BST-80/-105			Unit
			Min	Typ	Max	Min	Typ	Max	
ENCODE INPUT PARAMETERS									
Maximum Encode Rate	Full	VI	40/65			80/105			MSPS
Minimum Encode Rate	Full	IV				20/20			MSPS
Encode Pulse Width High ( $t_{EH}$ )	Full	IV	7/6			5/3.8			ns
Encode Pulse Width Low ( $t_{EL}$ )	Full	IV	7/6			5/3.8			ns
Aperture Delay ( $t_A$ )	25°C	V	2			2			ns
Aperture Uncertainty (Jitter)	25°C	V	3			3			ps rms
DIGITAL OUTPUT PARAMETERS									
Output Valid Time ( $t_V$ ) <sup>1</sup>	Full	VI	2.5			2.5			ns
Output Propagation Delay ( $t_{PD}$ ) <sup>1</sup>	Full	VI	4.5			4.5			ns
Output Rise Time ( $t_R$ )	25°C	V	1			1.0			ns
Output Fall Time ( $t_F$ )	25°C	V	1.2			1.2			ns
Out-of-Range Recovery Time	25°C	V	5			5			ns
Transient Response Time	25°C	V	5			5			ns
Recovery Time from Power-Down	25°C	V	10			10			Cycles
Pipeline Delay	Full	IV	5			5			Cycles

<sup>1</sup>  $t_V$  and  $t_{PD}$  are measured from the 1.5 level of the ENCODE input to the 50%/50% levels of the digital outputs swing. The digital output load during test is not to exceed an ac load of 5 pF or a dc current of  $\pm 40\ \mu\text{A}$ . Rise and fall times are measured from 10% to 90%.

## TIMING DIAGRAMS

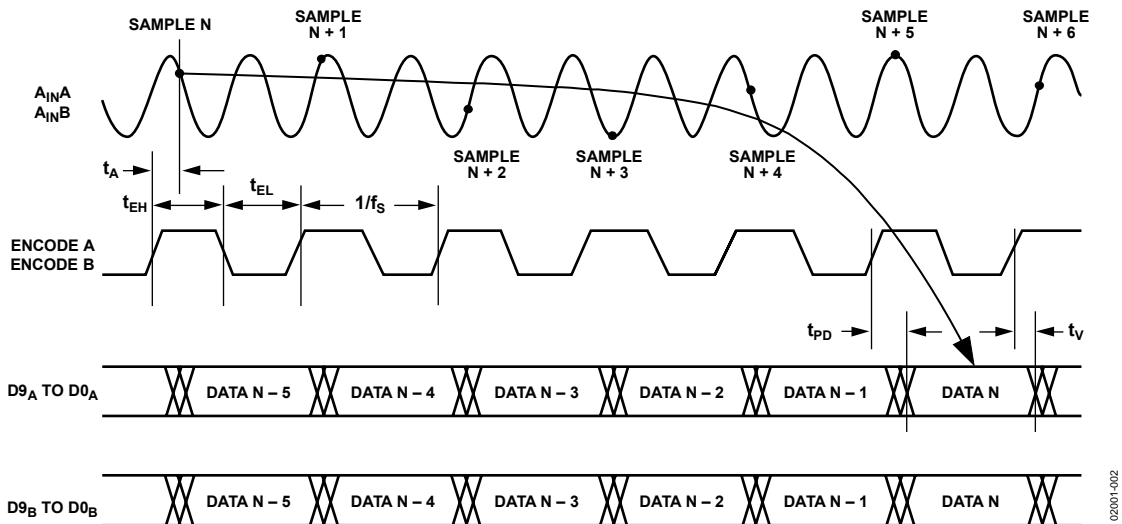

Figure 2. Normal Operation, Same Clock ( $S1 = 1, S2 = 0$ ) Channel Timing

02001-002

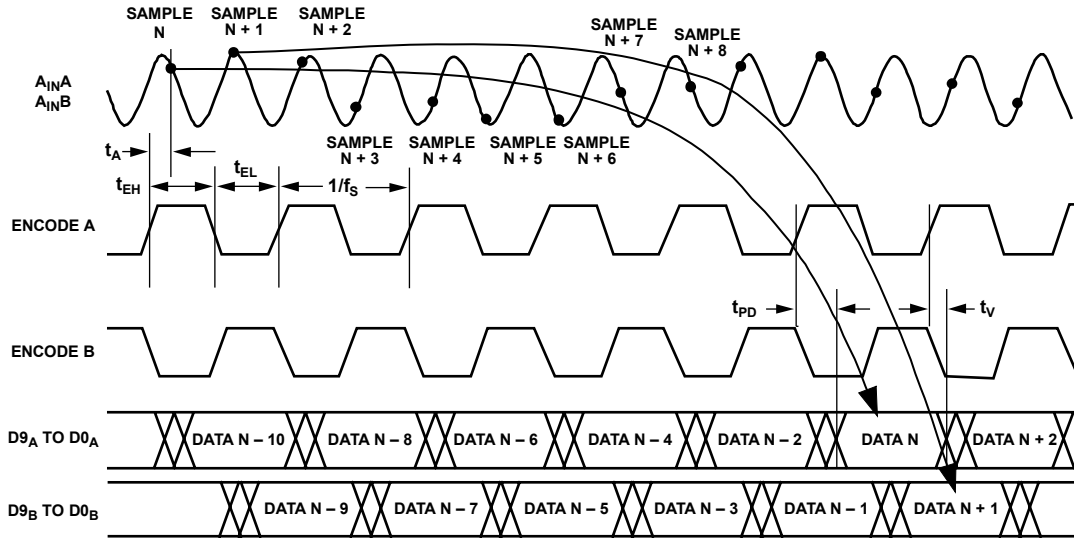

Figure 3. Normal Operation with Two Clock Sources ( $S1 = 1, S2 = 0$ ) Channel Timing

02001-003

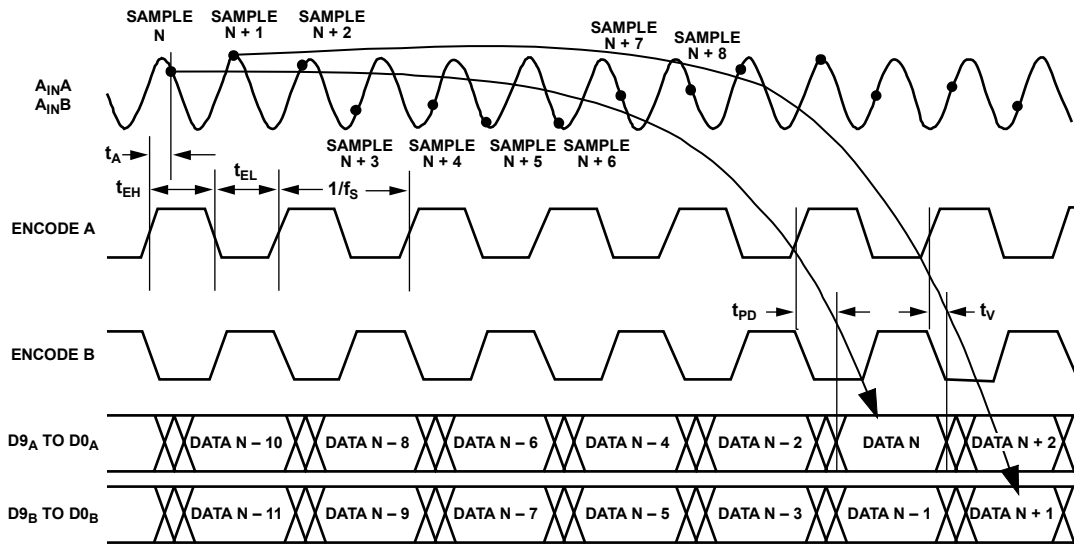

Figure 4. Data Align with Two Clock Sources ( $S1 = 1, S2 = 1$ ) Channel Timing

02001-004



## ABSOLUTE MAXIMUM RATINGS

Table 5.

Parameter	Rating
$V_D, V_{DD}$	4 V
Analog Inputs	-0.5 V to $V_D + 0.5$ V
Digital Inputs	-0.5 V to $V_{DD} + 0.5$ V
REF <sub>IN</sub> Inputs	-0.5 V to $V_D + 0.5$ V
Digital Output Current	20 mA
Operating Temperature	-55°C to +125°C
Storage Temperature	-65°C to +150°C
Maximum Junction Temperature	150°C
Maximum Case Temperature	150°C
$\theta_A$ (measured on a 4-layer board with solid ground plane)	57°C/W

Stresses above those listed under Absolute Maximum Ratings may cause permanent damage to the device. This is a stress rating only; functional operation of the device at these or any other conditions above those indicated in the operational section of this specification is not implied. Exposure to absolute maximum rating conditions for extended periods may affect device reliability.

## EXPLANATION OF TEST LEVELS

- I. 100% production tested.
- II. 100% production tested at 25°C and sample tested at specified temperatures.
- III. Sample tested only.
- IV. Parameter is guaranteed by design and characterization testing.
- V. Parameter is a typical value only.
- VI. 100% production tested at 25°C; guaranteed by design and characterization testing for industrial temperature range.  
100% production tested at temperature extremes for military devices.

Table 6. User Select Modes

S1	S2	Power-Down and Data Alignment Settings
0	0	Power down both Channel A and Channel B.
0	1	Power down Channel B only.
1	0	Normal operation (data align disabled).
1	1	Data align enabled (data from both channels available on rising edge of Clock A. Channel B data is delayed by a ½ clock cycle.)

## ESD CAUTION



### ESD (electrostatic discharge) sensitive device.

Charged devices and circuit boards can discharge without detection. Although this product features patented or proprietary protection circuitry, damage may occur on devices subjected to high energy ESD. Therefore, proper ESD precautions should be taken to avoid performance degradation or loss of functionality.

## PIN CONFIGURATION AND FUNCTION DESCRIPTIONS

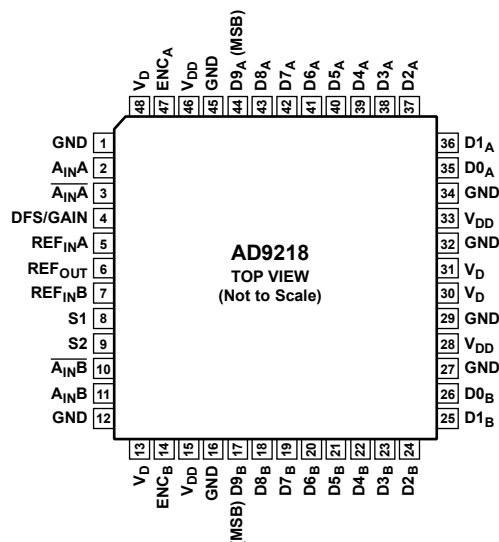

Figure 5. Pin Configuration

02001-005

Table 7. Pin Function Descriptions

Pin Number	Mnemonic	Description
1, 12, 16, 27, 29, 32, 34, 45	GND	Ground.
2	A <sub>IN</sub> A	Analog Input for Channel A.
3	$\overline{A}_{IN}A$	Analog Input for Channel A (Complementary).
4	DFS/GAIN	Data Format Select and Analog Input Gain Mode. Low = offset binary output available, 1 V p-p supported; high = twos complement output available, 1 V p-p supported; floating = offset binary output available, 2 V p-p supported; set to V <sub>REF</sub> = twos complement output available, 2 V p-p supported.
5	REF <sub>IN</sub> A	Reference Voltage Input for Channel A.
6	REF <sub>OUT</sub>	Internal Reference Voltage.
7	REF <sub>IN</sub> B	Reference Voltage Input for Channel B.
8	S1	User Select No. 1. See Table 6.
9	S2	User Select No. 2. See Table 6.
10	$\overline{A}_{IN}B$	Analog Input for Channel B (Complementary).
11	A <sub>IN</sub> B	Analog Input for Channel B.
13, 30, 31, 48	V <sub>D</sub>	Analog Supply (3 V).
14	ENC <sub>B</sub>	Clock Input for Channel B.
15, 28, 33, 46	V <sub>DD</sub>	Digital Supply (2.5 V to 3.6 V).
17 to 26	D <sub>9</sub> B to D <sub>0</sub> B	Digital Output for Channel B (D <sub>9</sub> B = MSB).
35 to 44	D <sub>0</sub> A to D <sub>9</sub> A	Digital Output for Channel A (D <sub>9</sub> A = MSB).
47	ENC <sub>A</sub>	Clock Input for Channel A.

## TERMINOLOGY

### Analog Bandwidth

The analog input frequency at which the spectral power of the fundamental frequency (as determined by the FFT analysis) is reduced by 3 dB.

### Aperture Delay

The delay between the 50% point of the rising edge of the ENCODE command and the instant at which the analog input is sampled.

### Aperture Uncertainty (Jitter)

The sample-to-sample variation in aperture delay.

### Crosstalk

Coupling onto one channel being driven by a low level signal (–40 dBFS) when the adjacent interfering channel is driven by a full-scale signal.

### Differential Analog Input Resistance, Differential Analog Input Capacitance, Differential Analog Input Impedance

The real and complex impedances measured at each analog input port. The resistance is measured statically and the capacitance and differential input impedances are measured with a network analyzer.

### Differential Analog Input Voltage Range

The peak-to-peak differential voltage that must be applied to the converter to generate a full-scale response. Peak differential voltage is computed by observing the voltage on a single pin and subtracting the voltage from the other pin, which is 180 degrees out of phase. Peak-to-peak differential is computed by rotating the input phase 180 degrees and again taking the peak measurement. The difference is then computed between both peak measurements.

### Differential Nonlinearity

The deviation of any code width from an ideal 1 LSB step.

### Effective Number of Bits (ENOB)

The effective number of bits is calculated from the measured SNR based on the equation

$$ENOB = \frac{SNR_{MEASURED} - 1.76 \text{ dB}}{6.02}$$

### ENCODE Pulse Width/Duty Cycle

Pulse width high is the minimum amount of time that the ENCODE pulse should be left in Logic 1 state to achieve rated performance; pulse width low is the minimum time ENCODE pulse should be left in low state. See timing implications of changing  $t_{ENCH}$  in text. At a given clock rate, these specifications define an acceptable ENCODE duty cycle.

### Full-Scale Input Power

Expressed in dbm. Computed using the following equation:

$$Power_{Full-Scale} = 10 \log \left( \frac{V_{Full-Scale}^2 \text{ rms}}{Z_{INPUT} \cdot 0.001} \right)$$

### Gain Error

Gain error is the difference between the measured and the ideal full-scale input voltage range of the ADC.

### Harmonic Distortion, Second

The ratio of the rms signal amplitude to the rms value of the second harmonic component, reported in dBc.

### Harmonic Distortion, Third

The ratio of the rms signal amplitude to the rms value of the third harmonic component, reported in dBc.

### Integral Nonlinearity

The deviation of the transfer function from a reference line measured in fractions of 1 LSB using a “best straight line” determined by a least-square curve fit.

### Minimum Conversion Rate

The encode rate at which the SNR of the lowest analog signal frequency drops by no more than 3 dB below the guaranteed limit.

### Maximum Conversion Rate

The encode rate at which parametric testing is performed.

### Output Propagation Delay

The delay between the 50% level crossing of ENCODE A or ENCODE B and the 50% level crossing of the respective channel's output data bit.

### Noise (for Any Range Within the ADC)

$$V_{NOISE} = \sqrt{Z \times 0.001 \times 10 \left( \frac{FS_{dBm} - SNR_{dBc} - Signal_{dBFS}}{10} \right)}$$

where  $Z$  is the input impedance,  $FS$  is the full scale of the device for the frequency in question,  $SNR$  is the value for the particular input level, and  $Signal$  is the signal level within the ADC reported in dB below full scale. This value includes both thermal and quantization noise.

### Power Supply Rejection Ratio

The ratio of a change in input offset voltage to a change in power supply voltage.

**Signal-to-Noise and Distortion (SINAD)**

The ratio of the rms signal amplitude (set 1 dB below full scale) to the rms value of the sum of all other spectral components, including harmonics but excluding dc.

**Signal-to-Noise Ratio (without Harmonics)**

The ratio of the rms signal amplitude (set at 1 dB below full scale) to the rms value of the sum of all other spectral components, excluding the first five harmonics and dc.

**Spurious-Free Dynamic Range (SFDR)**

The ratio of the rms signal amplitude to the rms value of the peak spurious spectral component. The peak spurious component may or may not be a harmonic. Reported in dBc (that is, degrades as signal level is lowered) or dBFS (always related back to converter full scale).

**Two-Tone Intermodulation Distortion Rejection**

The ratio of the rms value of either input tone to the rms value of the worst third-order intermodulation product; reported in dBc.

**Two-Tone SFDR**

The ratio of the rms value of either input tone to the rms value of the peak spurious component. The peak spurious component may or may not be an IMD product. Reported in dBc (that is, degrades as signal level is lowered) or in dBFS (always related back to converter full scale).

**Worst Other Spur**

The ratio of the rms signal amplitude to the rms value of the worst spurious component (excluding the second and third harmonics) reported in dBc.

**Transient Response Time**

Transient response is defined as the time it takes for the ADC to reacquire the analog input after a transient from 10% above negative full scale to 10% below positive full scale.

**Out-of-Range Recovery Time**

Out-of-range recovery time is the time it takes for the ADC to reacquire the analog input after a transient from 10% above positive full scale to 10% above negative full scale or from 10% below negative full scale to 10% below positive full scale.

EQUIVALENT CIRCUITS

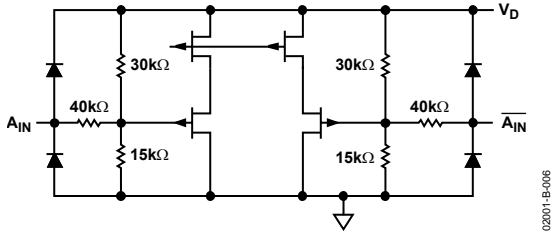

Figure 6. Analog Input Stage

02001-B-006

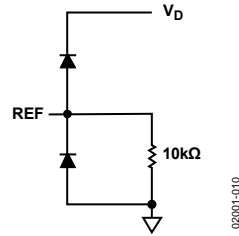

Figure 10. Reference Inputs

02001-010

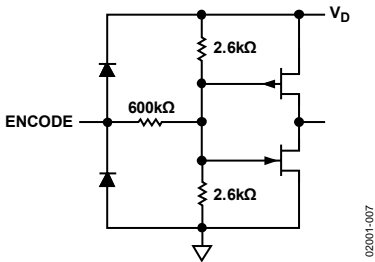

Figure 7. Encode Inputs

02001-007

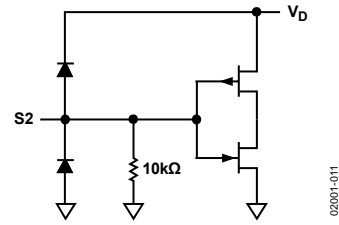

Figure 11. S2 Input

02001-011

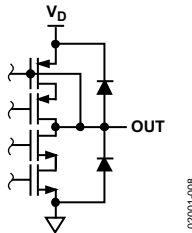

Figure 8. Reference Output Stage

02001-008

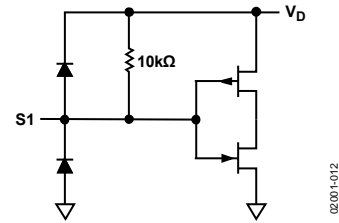

Figure 12. S1 Input

02001-012

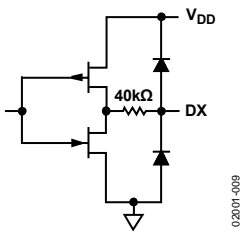

Figure 9. Digital Output Stage

02001-009

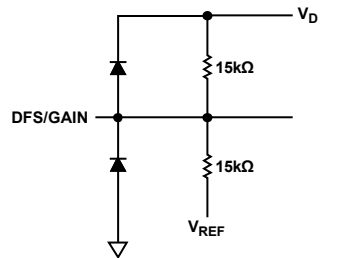

Figure 13. DFS/Gain Input

02001-013

# TYPICAL PERFORMANCE CHARACTERISTICS

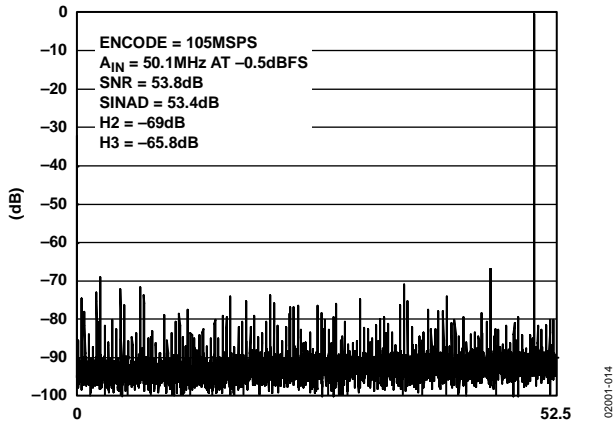

Figure 14. FFT: FS = 105 MSPS,  $A_{IN} = 50.1\text{ MHz @ } -0.5\text{ dBFS}$ , Differential, 1 V p-p Input Range

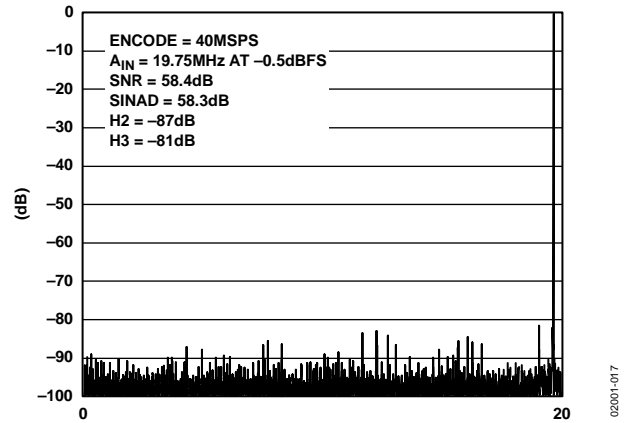

Figure 17. FFT: FS = 40 MSPS,  $A_{IN} = 19.75\text{ MHz @ } -0.5\text{ dBFS}$ , Differential, 1 V p-p Input Range

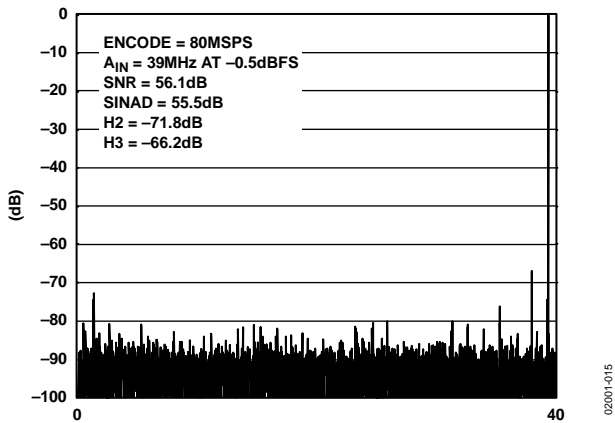

Figure 15. FFT: FS = 80 MSPS,  $A_{IN} = 39\text{ MHz @ } -0.5\text{ dBFS}$ , Differential, 1 V p-p Input Range

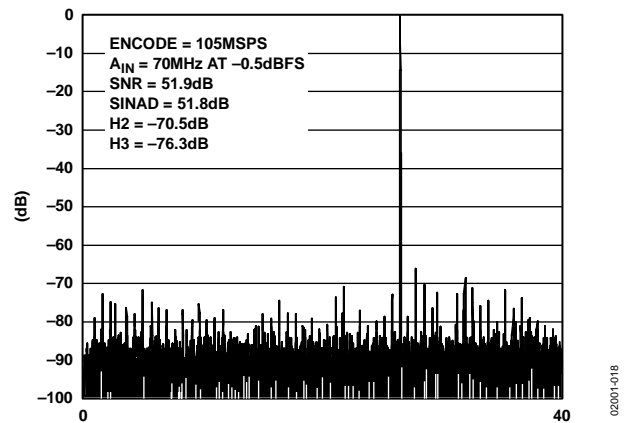

Figure 18. FFT: FS = 105 MSPS  $A_{IN} = 70\text{ MHz @ } -0.5\text{ dBFS}$ , Differential, 1 V p-p Input Range

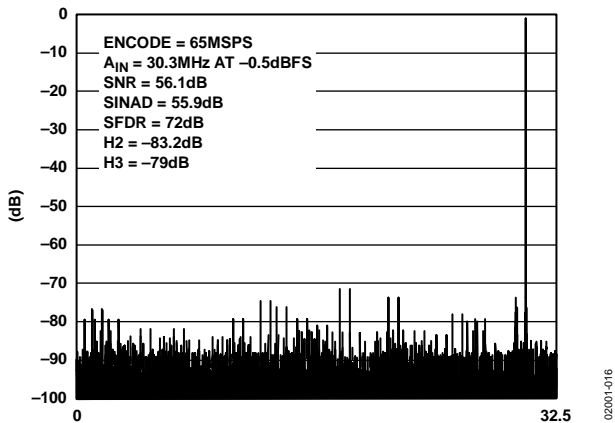

Figure 16. FFT: FS = 65 MSPS,  $A_{IN} = 30.3\text{ MHz @ } -0.5\text{ dBFS}$ , Differential, 2 V p-p Input Range

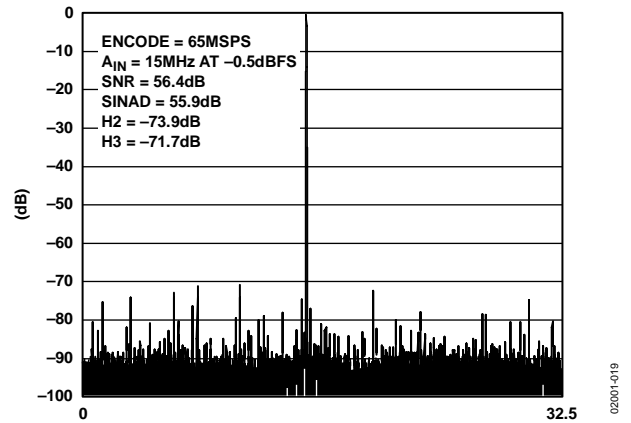

Figure 19. FFT: FS = 65 MSPS,  $A_{IN} = 15\text{ MHz @ } -0.5\text{ dBFS}$ ; with AD8138 Driving ADC Inputs, 1 V p-p Input Range

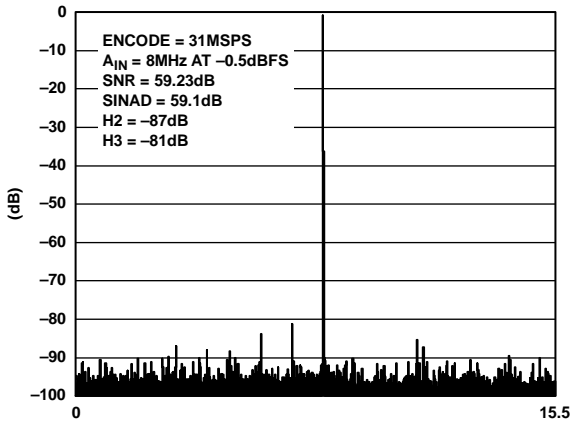

Figure 20. FFT: FS = 31 MSPS,  $A_{IN}$  = 8 MHz @ -0.5 dBFS, Differential, 1 V p-p Input Range

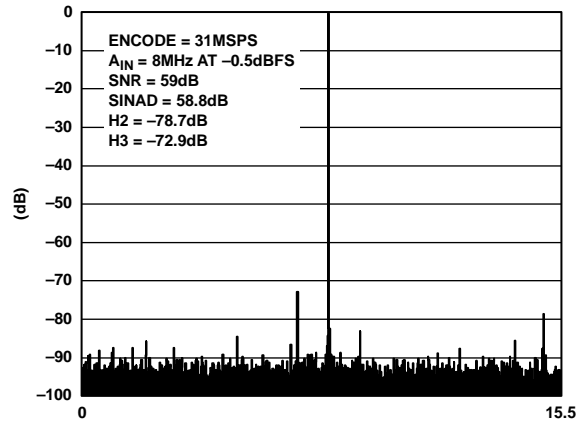

Figure 23. FFT: FS = 31 MSPS,  $A_{IN}$  = 8 MHz @ -0.5 dBFS, Differential, with AD8138 Driving ADC Inputs, 1 V p-p Input Range

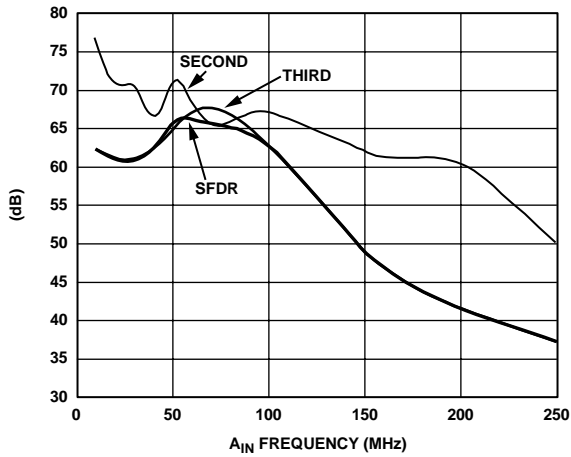

Figure 21. Harmonic Distortion (Second and Third) and SFDR vs.  $A_{IN}$  Frequency (1 V p-p, FS = 105 MSPS)

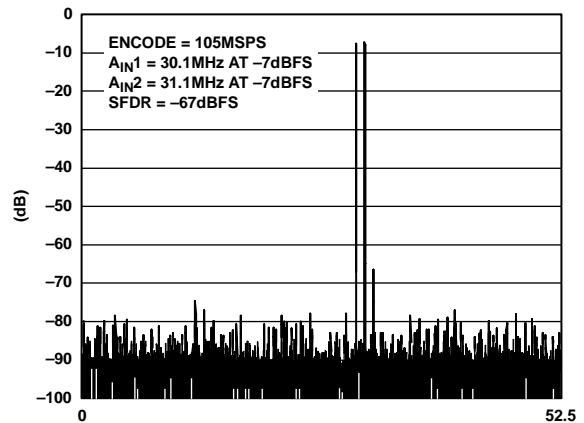

Figure 24. Two-Tone Intermodulation Distortion (30.1 MHz and 31.1 MHz; 1 V p-p, FS = 105 MSPS)

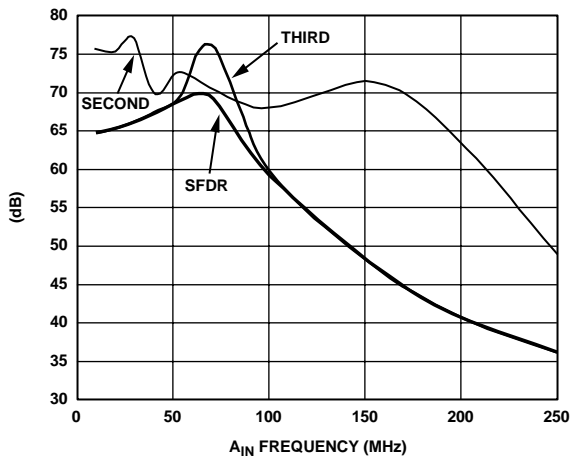

Figure 22. Harmonic Distortion (Second and Third) and SFDR vs.  $A_{IN}$  Frequency (1 V p-p, FS = 80 MSPS)

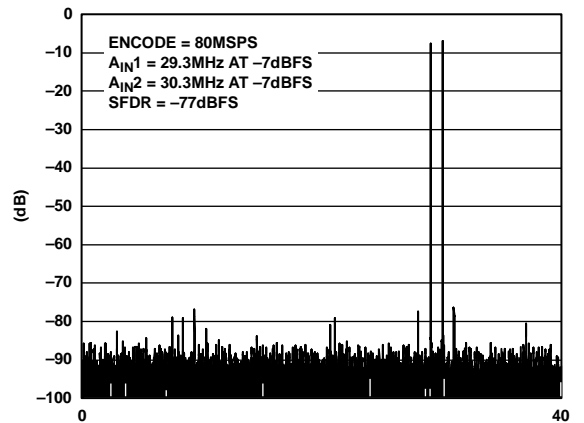

Figure 25. Two-Tone Intermodulation Distortion (29.3 MHz and 30.3 MHz; 1 V p-p, FS = 80 MSPS)

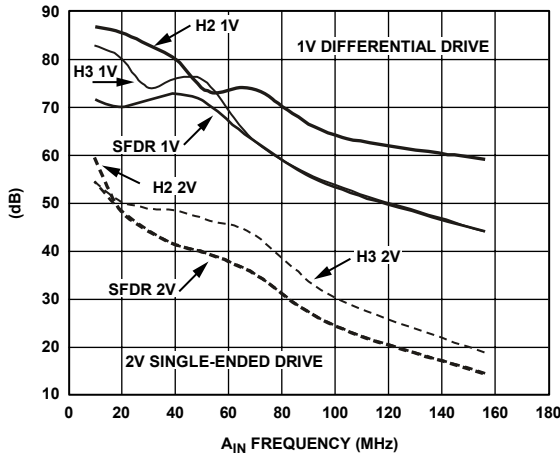

Figure 26. Harmonic Distortion (Second and Third) and SFDR vs.  $A_{IN}$  Frequency ( $F_S = 65$  MSPS)

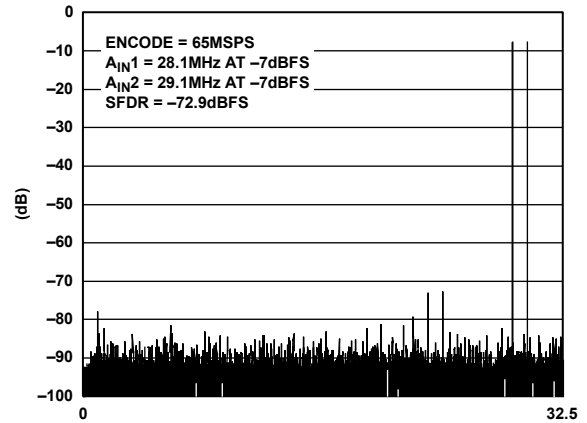

Figure 29. Two-Tone Intermodulation Distortion (28 MHz, 29 MHz; 1 V p-p,  $F_S = 65$  MSPS)

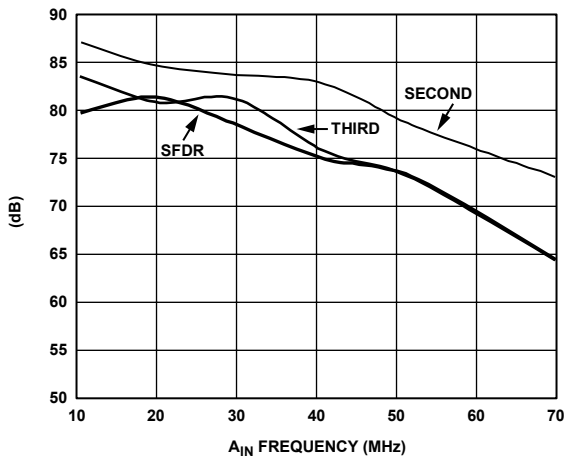

Figure 27. Harmonic Distortion (Second and Third) and SFDR vs.  $A_{IN}$  Frequency (1 V p-p,  $F_S = 40$  MSPS)

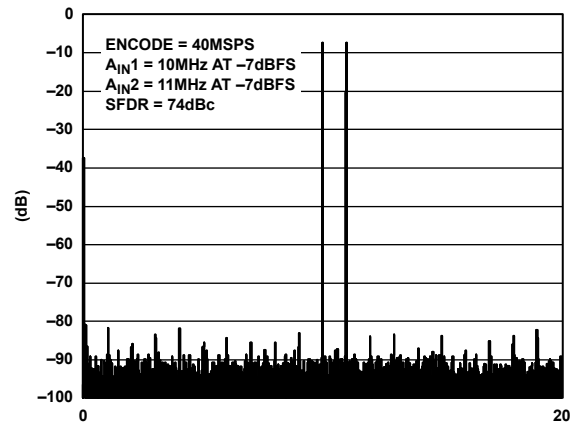

Figure 30. Two-Tone Intermodulation Distortion (10 MHz, 11 MHz; 1 V p-p,  $F_S = 40$  MSPS)

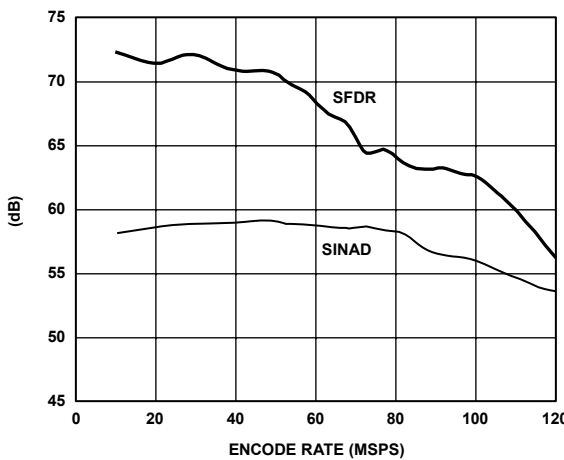

Figure 28. SINAD and SFDR vs. Encode Rate ( $A_{IN} = 10.3$  MHz, 105 MSPS Grade)  $A_{IN} = -0.5$  dBFS Differential, 1 V p-p Analog Input Range)

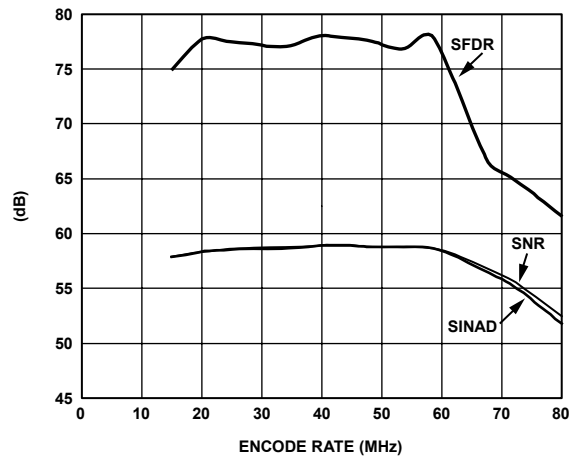

Figure 31. SINAD and SFDR vs. Encode Rate ( $A_{IN} = 10.3$  MHz, 65 MSPS Grade)  $A_{IN} = -0.5$  dBFS Differential, 1 V p-p Analog Input Range)



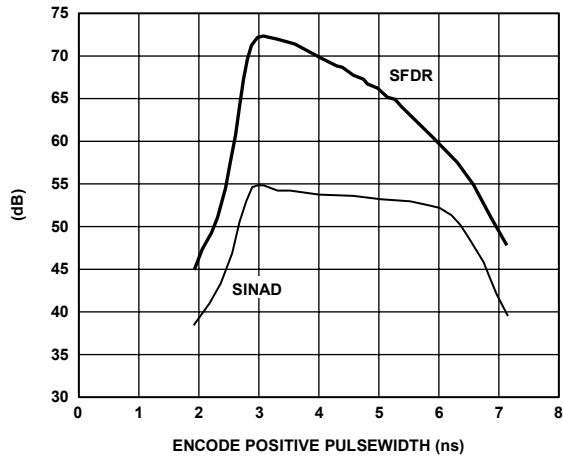

Figure 32. SINAD and SFDR vs. Encode Pulse Width High,  $A_{IN} = -0.5$  dBFS Single-Ended, 1 V p-p Analog Input Range 105 MSPS

02001-032

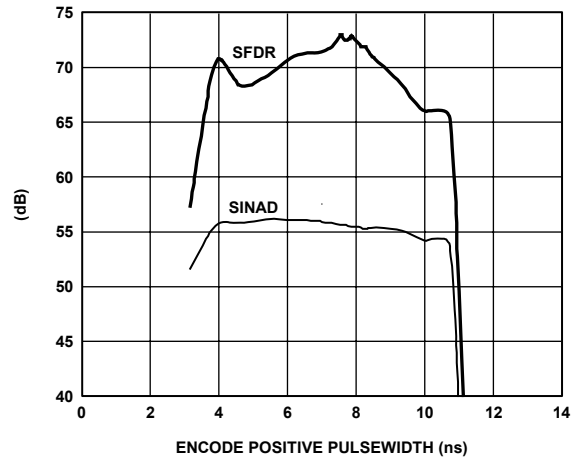

Figure 35. SINAD and SFDR vs. Encode Pulse Width High,  $A_{IN} = -0.5$  dBFS Single-Ended, 1 V p-p Analog Input Range 65 MSPS

02001-035

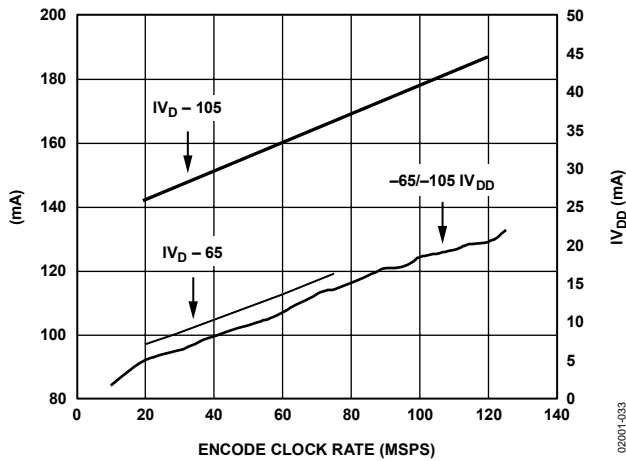

Figure 33.  $I_{V_D}$  and  $I_{V_{DD}}$  vs. Encode Rate ( $A_{IN} = 10.3$  MHz, @  $-0.5$  dBFS),  $-65$  MSPS/ $-105$  MSPS Grade  $C_I = 5$  pF

02001-033

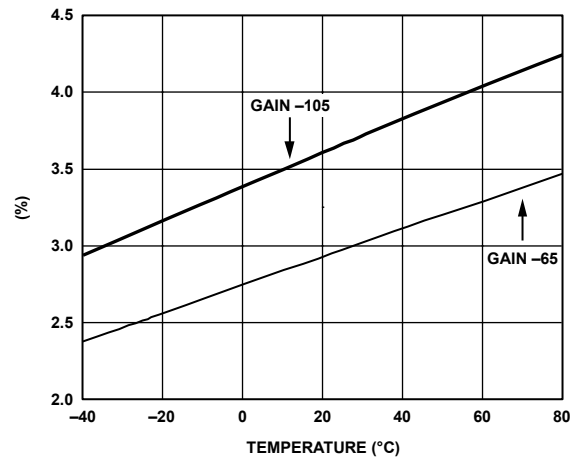

Figure 36. Gain Error vs. Temperature,  $A_{IN} = 10.3$  MHz,  $-65$  MSPS Grade,  $-105$  MSPS Grade, 1 V p-p

02001-036

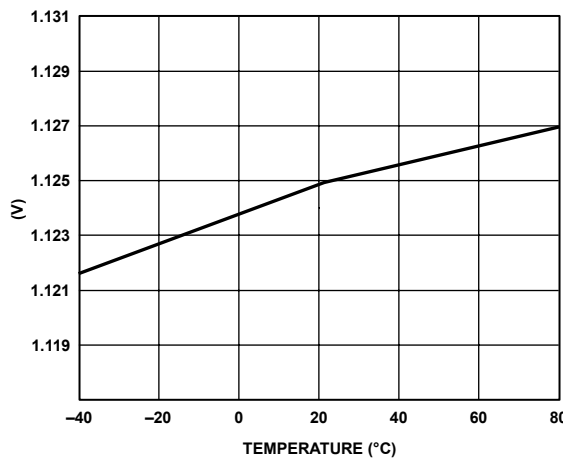

Figure 34.  $V_{REF}$  Output Voltage vs. Temperature ( $I_{LOAD} = 300$   $\mu$ A)

02001-034

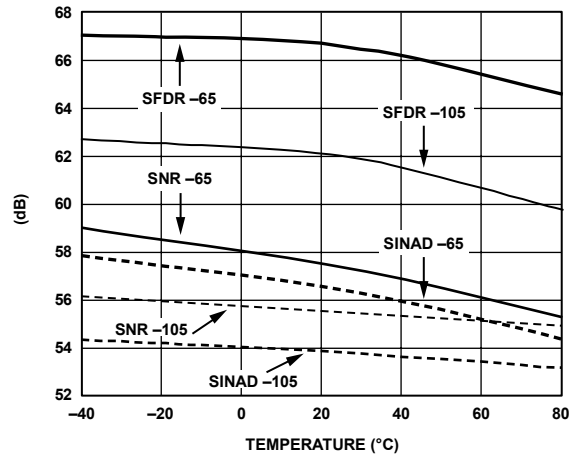

Figure 37. SNR, SINAD, SFDR vs. Temperature,  $A_{IN} = 10.3$  MHz,  $-65$  MSPS Grade,  $-105$  MSPS Grade, 1 V p-p

02001-037

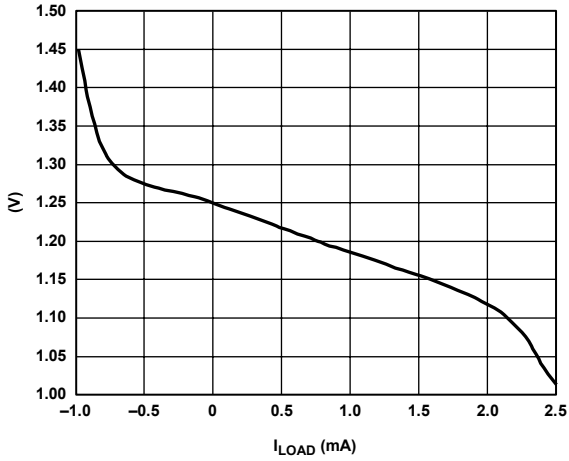

Figure 38.  $V_{REF}$  vs.  $I_{LOAD}$

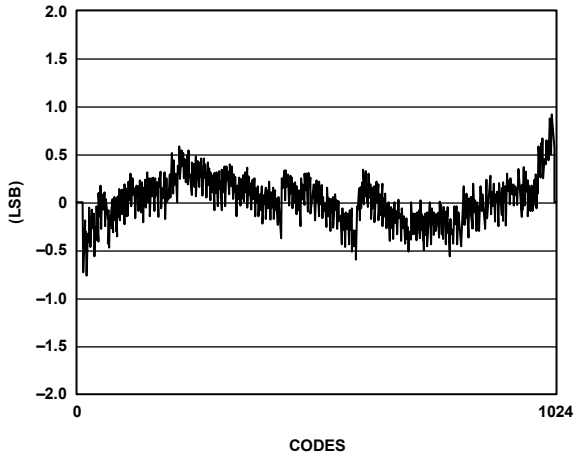

Figure 39. Typical INL Plot, 10.3 MHz  $A_{IN}$  @ 80 MSPS

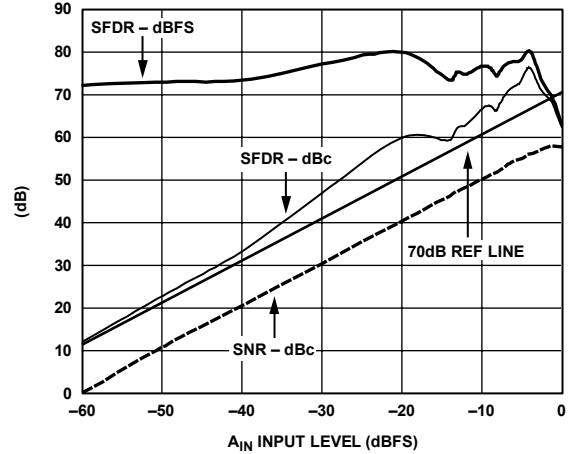

Figure 40. SFDR vs.  $A_{IN}$  Input Level, 10.3 MHz  $A_{IN}$  @ 80 MSPS

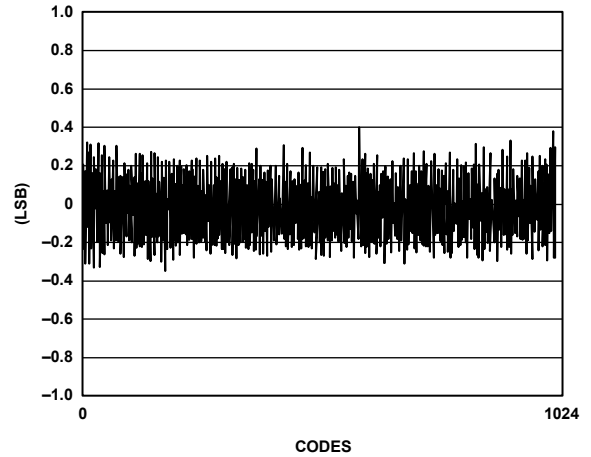

Figure 41. Typical DNL Plot, 10.3 MHz  $A_{IN}$  @ 80 MSPS

02001-038

02001-040

02001-039

02001-041

## THEORY OF OPERATION

The AD9218 ADC architecture is a bit-per-stage pipeline-type converter utilizing switch capacitor techniques. These stages determine the 7 MSBs and drive a 3-bit flash. Each stage provides sufficient overlap and error correction, allowing optimization of comparator accuracy. The input buffers are differential, and both sets of inputs are internally biased. This allows the most flexible use of ac-coupled or dc-coupled and differential or single-ended input modes. The output staging block aligns the data, carries out the error correction, and feeds the data to output buffers. The set of output buffers are powered from a separate supply, allowing adjustment of the output voltage swing. There is no discernible difference in performance between the two channels.

### USING THE AD9218 ENCODE INPUT

Any high speed ADC is extremely sensitive to the quality of the sampling clock provided by the user. A track-and-hold circuit is essentially a mixer. Any noise, distortion, or timing jitter on the clock is combined with the desired signal at the analog-to-digital output. For that reason, considerable care has been taken in the design of the ENCODE input of the AD9218, and the user is advised to give commensurate thought to the clock source. The ENCODE input is fully TTL/CMOS compatible.

### DIGITAL OUTPUTS

The digital outputs are TTL/CMOS compatible for lower power consumption. During power-down, the output buffers transition to a high impedance state. A data format selection option supports either twos complement (set high) or offset binary output (set low) formats.

## ANALOG INPUT

The analog input to the AD9218 is a differential buffer. For best dynamic performance, impedance at  $A_{IN}$  and  $\bar{A}_{IN}$  should match. Special care was taken in the design of the analog input section of the AD9218 to prevent damage and data corruption when the input is overdriven. The nominal input range is 1.024 V p-p. Optimum performance is obtained when the part is driven differentially where common-mode noise is minimized and even-order harmonics are reduced. Figure 42 shows an example of the AD9218 being driven differentially via a wideband RF transformer for ac-coupled applications. As shown in Figure 43, applications that require dc-coupled differential drives can be accommodated using the AD8138 differential output op amp.

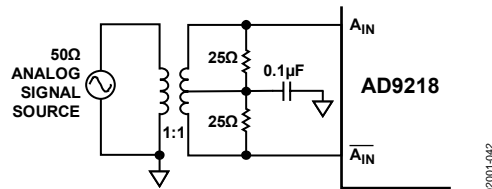

Figure 42. Using a Wideband Transformer to Drive the AD9218

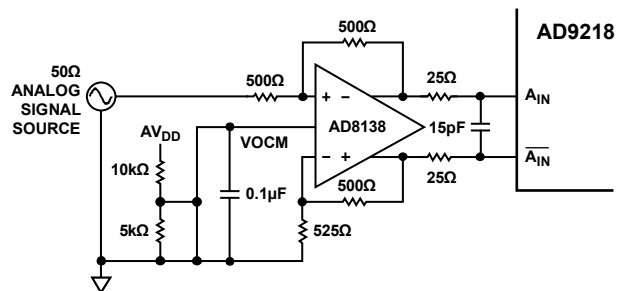

Figure 43. Using the AD8138 to Drive the AD9218

## VOLTAGE REFERENCE

A stable and accurate 1.25 V voltage reference is built into the AD9218 (VREF OUT). Typically, the internal reference is used by strapping Pin 5 (REF<sub>INA</sub>) and Pin 7 (REF<sub>INB</sub>) to Pin 6 (REF<sub>OUT</sub>). The input range for each channel can be adjusted independently by varying the reference voltage inputs applied to the AD9218. No appreciable degradation in performance occurs when the reference is adjusted  $\pm 5\%$ . The full-scale range of the ADC tracks reference voltage, which changes linearly (a 5% change in VREF results in a 5% change in full scale).

## TIMING

The AD9218 provides latched data outputs, with five pipeline delays. Data outputs are available one propagation delay ( $t_{PD}$ ) after the rising edge of the encode command (see Figure 2 through Figure 4). The length of the output data lines and loads placed on them should be minimized to reduce transients within the AD9218. These transients can detract from the dynamic performance of the converter.

The minimum guaranteed conversion rate is 20 MSPS. At clock rates below 20 MSPS, dynamic performance degrades.

## USER SELECT OPTIONS

Two pins are available for a combination of operational modes, enabling the user to power down both channels, excluding the reference, or just the B channel. Both modes place the output buffers in a high impedance state. Recovery from a power-down state is accomplished in 10 clock cycles following power-on.

The other option allows the user to skew the B channel output data by one-half a clock cycle. In other words, if two clocks are fed to the AD9218 and are 180 degrees out of phase, enabling the data align allows Channel B output data to be available at the rising edge of Clock A. If the same encode clock is provided to both channels and the data align pin is enabled, output data from Channel B is 180 degrees out of phase with respect to Channel A. If the same encode clock is provided to both channels and the data align pin is disabled, both outputs are delivered on the same rising edge of the clock.

## APPLICATION INFORMATION

The wide analog bandwidth of the AD9218 makes it very attractive for a variety of high performance receiver and encoder applications. Figure 44 shows the dual ADC in a typical low cost I and Q demodulator implementation for cable, satellite, or wireless LAN modem receivers. The excellent dynamic performance of the ADC at higher analog input frequencies and encode rates lets users employ direct IF sampling techniques. IF sampling eliminates or simplifies analog mixer and filter stages to reduce total system cost and power.

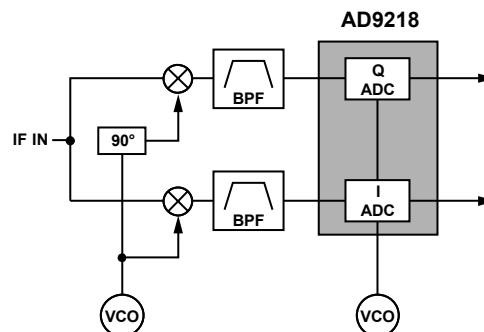

Figure 44. Typical I/Q Demodulation Scheme

02001-044

# AD9218

## AD9218/AD9288 CUSTOMER PCB BOM

Table 8. Bill of Materials

No.	Qty	Reference Designator	Device	Package	Value	Comments
1	29	C1, C3 to C15, C20, C21, C24, C25, C27, C30 to C35, C39 to C42	Capacitor	0603	0.1 $\mu$ F	
2	2	C2, C36	Capacitor	0603	15 pF	8138 out
3	7	C16–C19, C26, C37, C38	Capacitor	TAJD	10 $\mu$ F	
4	28	E1, E2, E3, E4, E12 to E30, E34 to E38	W-HOLE	W-HOLE		
5	4	H1, H2, H3, H4	MTHOLE	MTHOLE		
6	5	J1, J2, J3, J4, J5	SMA	SMA		J2, J3 not placed
7	3	P1, P4, P11	4-lead power connector	Post	Z5.531.3425.0	Wieland
8	3	P1, P4, P11	4-lead power connector	Detachable connector	25.602.5453.0	Wieland
9	1	P2, P3 <sup>1</sup>	80-lead rt. angle male		TSW-140-08-L-D-RA	Samtec
10	4	R1, R2, R32, R34	Resistor	0603	36 $\Omega$	R1, R2, R32, R34, not placed
11	9	R3, R7, R11, R14, R22, R23, R24, R30, R51	Resistor	0603	50 $\Omega$	R11, R22, R23, R24, R30, R51 not placed
12	17	R4, R5, R8, R9, R10, R12, R13, R20, R33, R35, R36, R37, R40, R42, R43, R50, R53	Resistor	0603	0 $\Omega$	R43, R50 not placed
13	2	R6, R38	Resistor	0603	25 $\Omega$	R6, R38 not placed
14	6	R15, R16, R18, R26, R29, R31	Resistor	0603	500 $\Omega$	R16, R29 not placed
15	2	R17, R25	Resistor	0603	525 $\Omega$	
16	2	R19, R27	Resistor	0603	4 k $\Omega$	
17	12	R21, R28, R39, R41, R44, R46 to R49, R52, R54, R55	Resistor	0603	1 k $\Omega$	
18	2	T1, T2	Transformer	ADT1-1WT		Minicircuits
19	1	U1	AD9288 or AD9218 <sup>2</sup>	LQFP48		
20	2	U2, U3	74LCX821			
21	2	U5, U6	SN74VCX86			
22	4	U7, U8, U9, U10	Resistor array	CTS	47 $\Omega$	768203470G
23	2	U11, U12	AD8138 op amp <sup>3</sup>			

<sup>1</sup> P2, P3 are implemented as one physical 80-lead connector SAMTEC TSW-140-08-L-D-RA.

<sup>2</sup> AD9288/PCB populated with AD9288-100, AD9218-65/PCB populated with AD9218-65, AD9218-105/PCB populated with AD9218-105.

<sup>3</sup> To use optional amp place R22, R23, R30, R24, R16, R29, remove R4, R36.

## EVALUATION BOARD

The AD9218/AD9288 customer evaluation board offers an easy way to test the AD9218 or the AD9288. The compatible pinout of the two parts facilitates the use of one PCB for testing either part. The PCB requires power supplies, a clock source, and a filtered analog source for most ADC testing required.

### POWER CONNECTOR

Power is supplied to the board via a detachable 12-lead power strip. The minimum 3 V supplies required to run the board are  $V_D$ ,  $V_{DL}$ , and  $V_{DD}$ . To allow the use of the optional amplifier path,  $\pm 5$  V supplies are required.

### ANALOG INPUTS

Each channel has an independent analog path that uses a wideband transformer to drive the ADC differentially from a single-ended sine source at the input SMAs. The transformer paths can be bypassed to allow the use of a dc-coupled path using two AD8138 op amps with a simple board modification. The analog input should be band-pass filtered to remove any harmonics in the input signal and to minimize aliasing.

### VOLTAGE REFERENCE

The AD9218 has an internal 1.25 V voltage reference; an external reference for each channel can be employed instead by connecting two external voltage references at the power connector and setting jumpers at E18 and E19. The evaluation board is shipped configured for internal reference mode.

### CLOCKING

Each channel can be clocked by a common clock input at SMA inputs ENCODE A and ENCODE B. The channels can also be clocked independently by a simple board modification. The clock input should be a low jitter sine source for maximum performance.

### DATA OUTPUTS

The data outputs are latched on board by two 10-bit latches and drive an 8-lead connector, which is compatible with the dual-channel FIFO board that is available from Analog Devices, Inc. This board, together with ADC analyzer software, can greatly simplify ADC testing.

### DATA FORMAT/GAIN

The DFS/GAIN pin can be biased for desired operation at the DFS jumper located at the S1, S2 jumpers.

### TIMING

Timing on each channel can be controlled, if needed, on the PCB. Clock signals at the latches or the data ready signals that go to the output 80-lead connector can be inverted if required. Jumpers also allow for biasing of Pin S1 and Pin S2 for power-down and timing alignment control.

### TROUBLESHOOTING

If the board does not seem to be working correctly, try the following:

- Verify power at the IC pins.
- Check that all jumpers are in the correct position for the desired mode of operation.
- Verify that  $V_{REF}$  is at 1.23 V.
- Try running encode clock and analog inputs at low speeds (20 MSPS/1 MHz) and monitor the LCX821 outputs, DAC outputs, and ADC outputs for toggling.

The AD9218 evaluation board is provided as a design example for customers of Analog Devices. Analog Devices makes no warranties, express, statutory, or implied, regarding merchantability or fitness for a particular purpose.

# AD9218

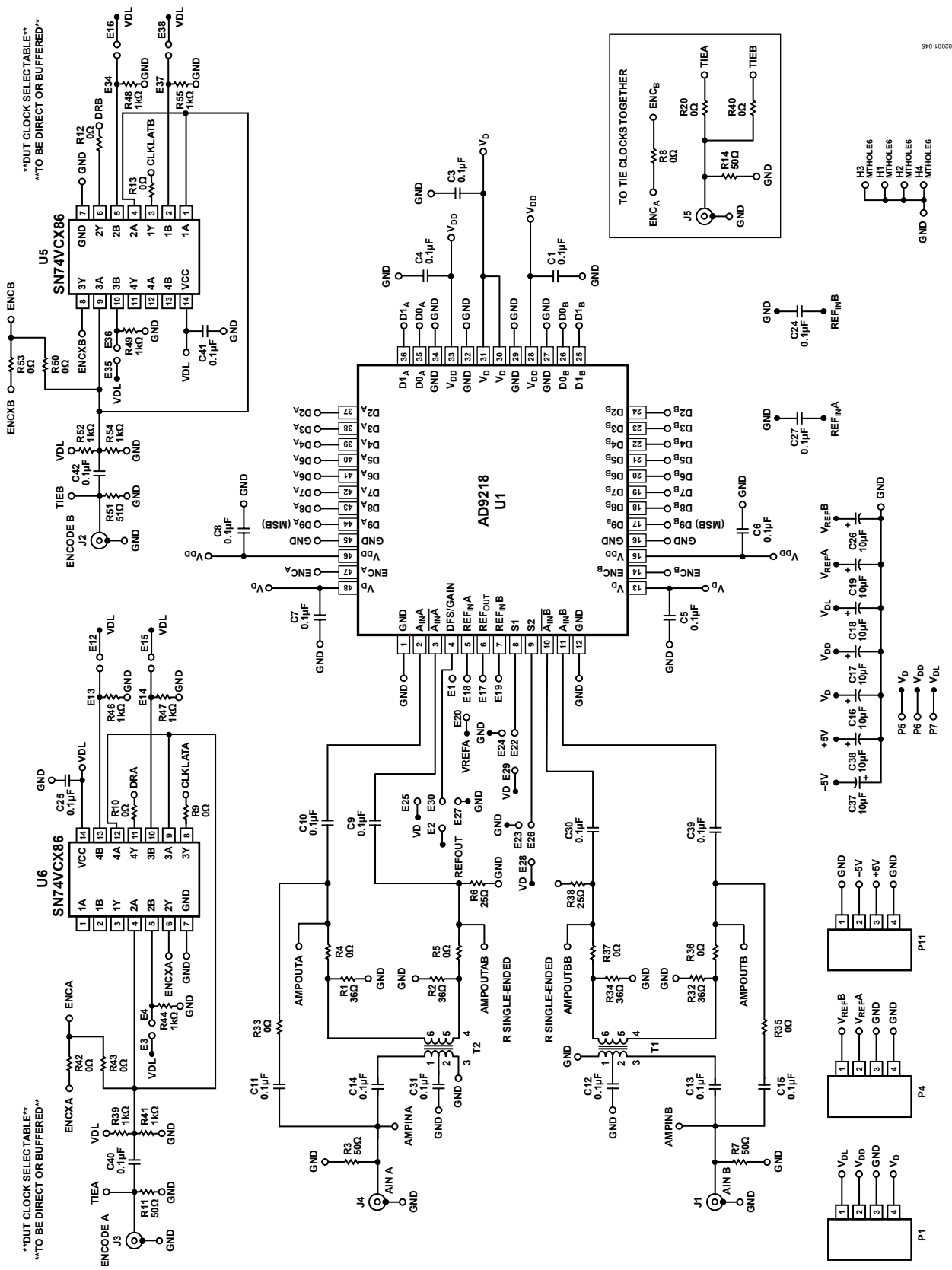

Figure 45. PCB Schematic

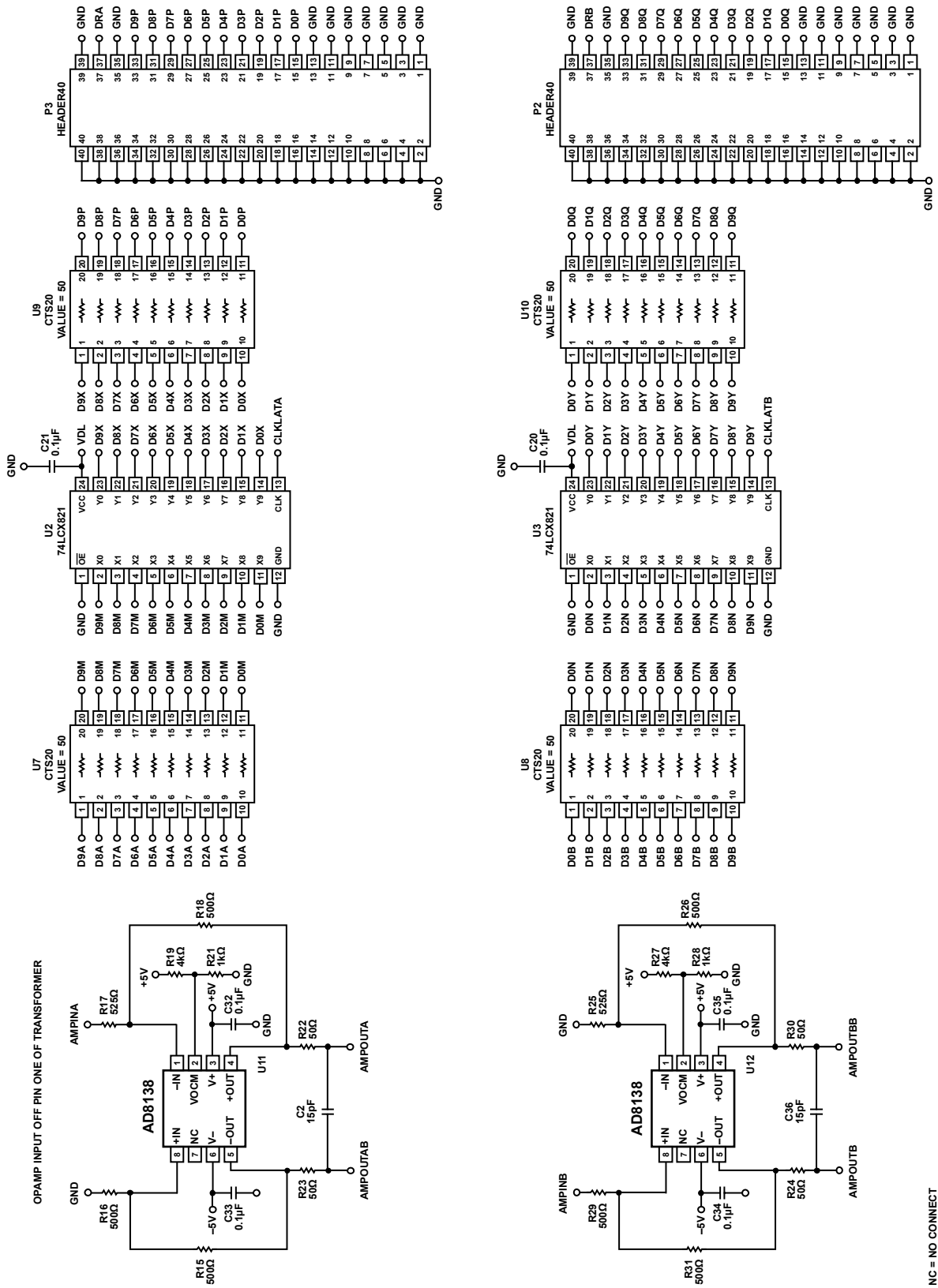

Figure 46. PCB Schematic (Continued)

NC = NO CONNECT



# AD9218

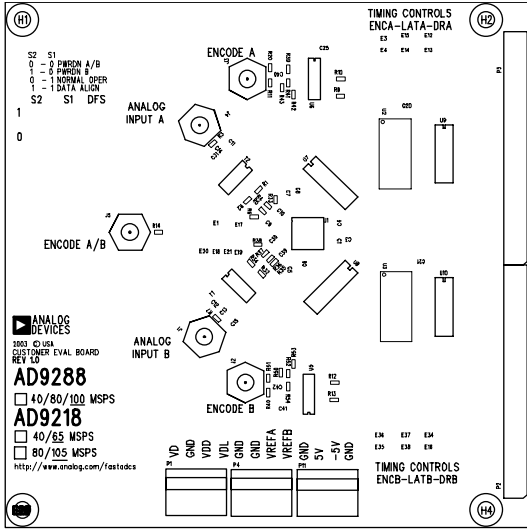

Figure 47. Top Silkscreen

02001-047

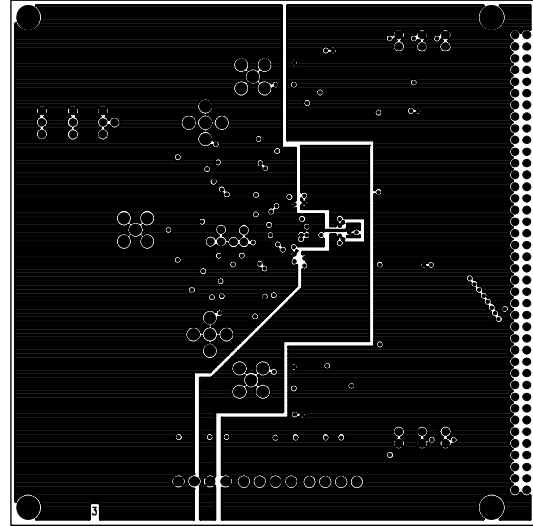

Figure 50. Split Power Plane

02001-050

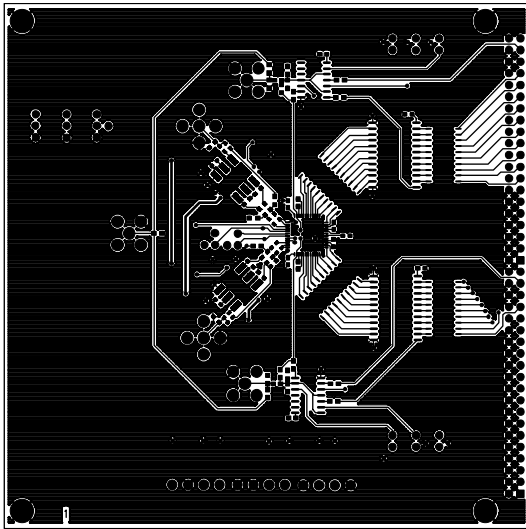

Figure 48. Top Routing

02001-048

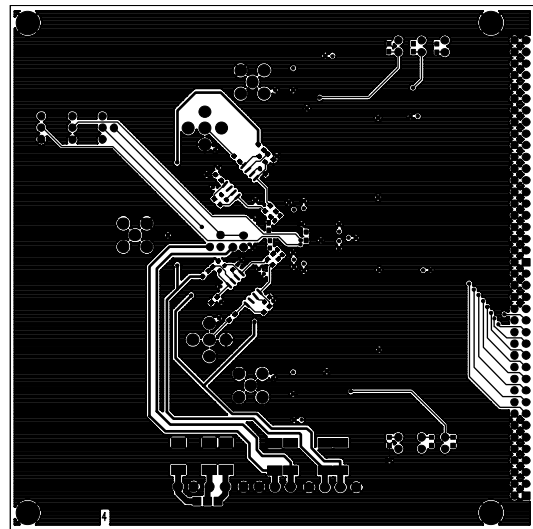

Figure 51. Bottom Routing

02001-051

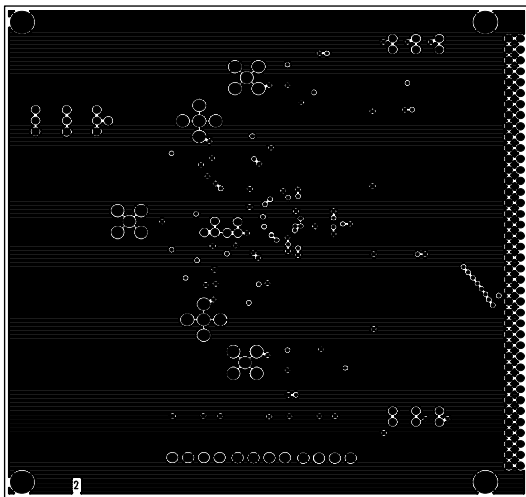

Figure 49. Ground Plane

02001-049

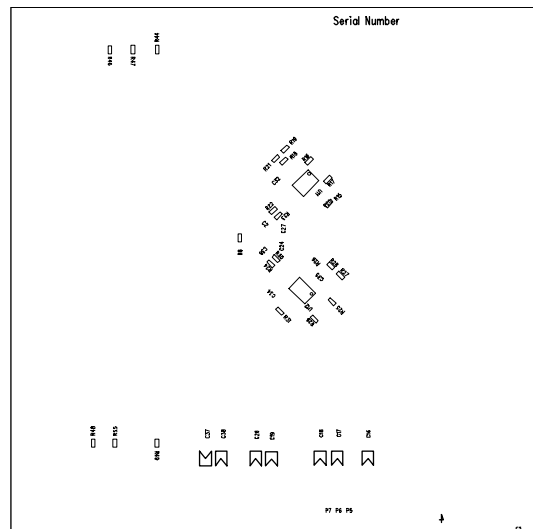
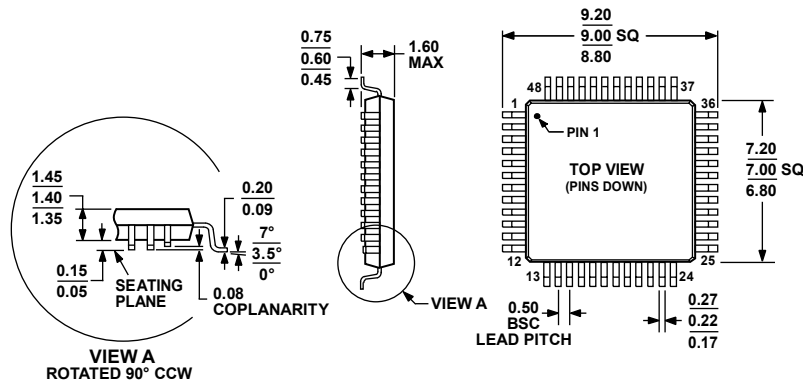

Figure 52. Bottom Silkscreen

02001-052

# OUTLINE DIMENSIONS



COMPLIANT TO JEDEC STANDARDS MS-026-BBC

Figure 53. 48-Lead Low Profile Quad Flat Package [LQFP] (ST-48)

Dimensions shown in millimeters

05706-A

## ORDERING GUIDE

Model	Temperature Range	Package Description	Package Option
AD9218BST-40	-40°C to +85°C	48-Lead Low Profile Quad Flat Pack (LQFP)	ST-48
AD9218BST-RL40	-40°C to +85°C	48-Lead Low Profile Quad Flat Pack (LQFP)	ST-48
AD9218BSTZ-40 <sup>1</sup>	-40°C to +85°C	48-Lead Low Profile Quad Flat Pack (LQFP)	ST-48
AD9218BSTZ-RL40 <sup>1</sup>	-40°C to +85°C	48-Lead Low Profile Quad Flat Pack (LQFP)	ST-48
AD9218BST-65	-40°C to +85°C	48-Lead Low Profile Quad Flat Pack (LQFP)	ST-48
AD9218BST-RL65	-40°C to +85°C	48-Lead Low Profile Quad Flat Pack (LQFP)	ST-48
AD9218BSTZ-65 <sup>1</sup>	-40°C to +85°C	48-Lead Low Profile Quad Flat Pack (LQFP)	ST-48
AD9218BSTZ-RL65 <sup>1</sup>	-40°C to +85°C	48-Lead Low Profile Quad Flat Pack (LQFP)	ST-48
AD9218BST-80	-40°C to +85°C	48-Lead Low Profile Quad Flat Pack (LQFP)	ST-48
AD9218BST-RL80	-40°C to +85°C	48-Lead Low Profile Quad Flat Pack (LQFP)	ST-48
AD9218BSTZ-80 <sup>1</sup>	-40°C to +85°C	48-Lead Low Profile Quad Flat Pack (LQFP)	ST-48
AD9218BSTZ-RL80 <sup>1</sup>	-40°C to +85°C	48-Lead Low Profile Quad Flat Pack (LQFP)	ST-48
AD9218BST-105	-40°C to +85°C	48-Lead Low Profile Quad Flat Pack (LQFP)	ST-48
AD9218BST-RL105	-40°C to +85°C	48-Lead Low Profile Quad Flat Pack (LQFP)	ST-48
AD9218BSTZ-105 <sup>1</sup>	-40°C to +85°C	48-Lead Low Profile Quad Flat Pack (LQFP)	ST-48
AD9218BSTZ-RL105 <sup>1</sup>	-40°C to +85°C	48-Lead Low Profile Quad Flat Pack (LQFP)	ST-48
AD9218-65PCB		Evaluation Board (Supports -40/-65 Grade)	
AD9218-105PCB		Evaluation Board (Supports -80/-105 Grade)	

<sup>1</sup> Z = Pb-free part.

**AD9218**

**NOTES**

**NOTES**

**AD9218**

**NOTES**