

MMBTA44-G (NPN) RoHS Device

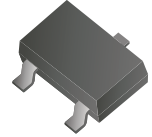

Features

- High Collector-emitter voltage.
- Ultra small surface mount package.

Mechanical data

- Case: SOT-23 Standard package, molded plastic.
- Terminals: Solderable per MIL-STD-750, method 2026.
- Mounting position: Any.
- Weight: 0.0078 grams(approx.).

Diagram:

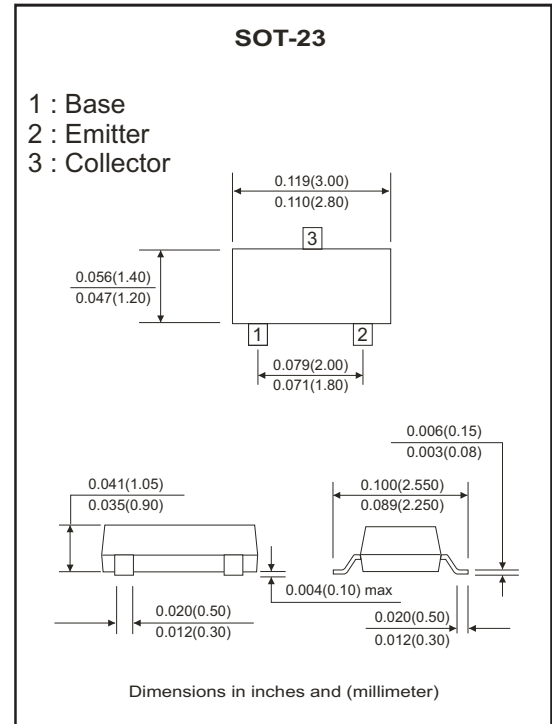
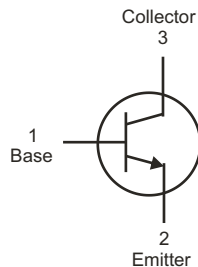

Maximum Ratings (at $T_A=25^\circ\text{C}$ unless otherwise noted)

Parameter	Symbol	Value	Unit
Collector-base voltage	V_{CB0}	400	V
Collector-emitter voltage	V_{CE0}	400	V
Emitter-base voltage	V_{EB0}	6	V
Collector current-continuous	I_c	200	mA
Collector current-pulsed	I_{CM}	300	mA
Collector power dissipation	P_c	350	mW
Thermal resistance from junction to ambient	$R_{\theta JA}$	357	$^\circ\text{C/W}$
Junction temperature range	T_J	150	$^\circ\text{C}$
Storage temperature range	T_{STG}	-55 to +150	$^\circ\text{C}$

Electrical Characteristics (Ta=25°C, unless otherwise specified)

Parameter	Conditions	Symbol	Min	Max	Unit
Collector-base breakdown voltage	$I_C=100\mu A, I_E=0$	$V_{(BR)CBO}$	400		V
Collector-emitter breakdown voltage	$I_C=1mA, I_B=0$	$V_{(BR)CEO}^*$	400		V
Emitter-base breakdown voltage	$I_E=10\mu A, I_C=0$	$V_{(BR)EBO}$	6		V
Collector cut-off current	$V_{CB}=400V, I_E=0$	I_{CBO}		0.1	μA
Emitter cut-off current	$V_{EB}=4V, I_C=0$	I_{EBO}		0.1	μA
DC current gain	$V_{CE}=10V, I_C=1mA$	$h_{FE(1)}^*$	40		
	$V_{CE}=10V, I_C=10mA$	$h_{FE(2)}^*$	50	200	
	$V_{CE}=10V, I_C=50mA$	$h_{FE(3)}^*$	45		
	$V_{CE}=10V, I_C=100mA$	$h_{FE(4)}^*$	40		
Collector-emitter saturation voltage	$I_C=1mA, I_B=0.1mA$	$V_{CE(sat)1}^*$		0.4	V
	$I_C=10mA, I_B=1mA$	$V_{CE(sat)2}^*$		0.5	V
	$I_C=50mA, I_B=5mA$	$V_{CE(sat)3}^*$		0.75	V
Base-emitter saturation voltage	$I_C=10mA, I_B=1mA$	$V_{BE(sat)}^*$		0.75	V
Collector output capacitance	$V_{CB}=20V, I_E=0, f=1MHz$	C_{ob}		7	pF
Emitter input capacitance	$V_{EB}=0.5V, I_C=0, f=1MHz$	C_{ib}		130	pF

*Pulse test: pulse width $\leq 300\mu s$, duty cycle $\leq 2.0\%$

RATING AND CHARACTERISTIC CURVES (MMBTA44-G)

Fig.1 - Static Characteristic

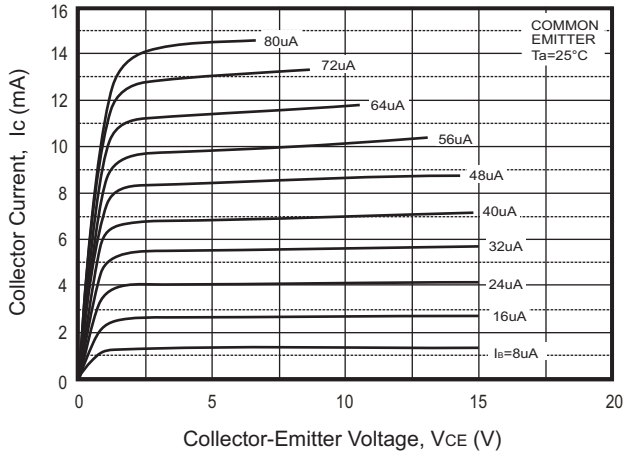

Fig.2 - h_{FE} - I_c

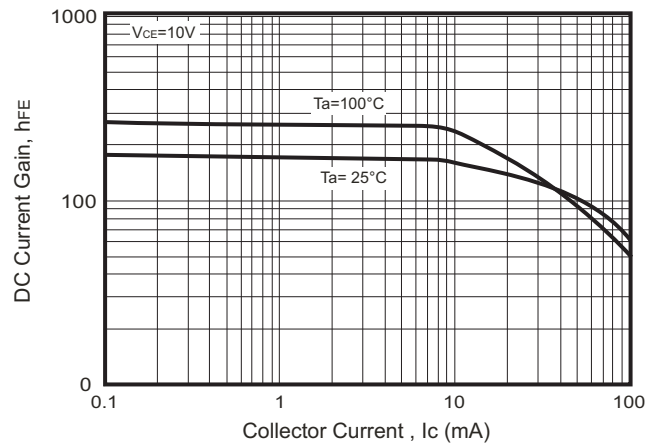

Fig.3 - V_{BEsat} - I_c

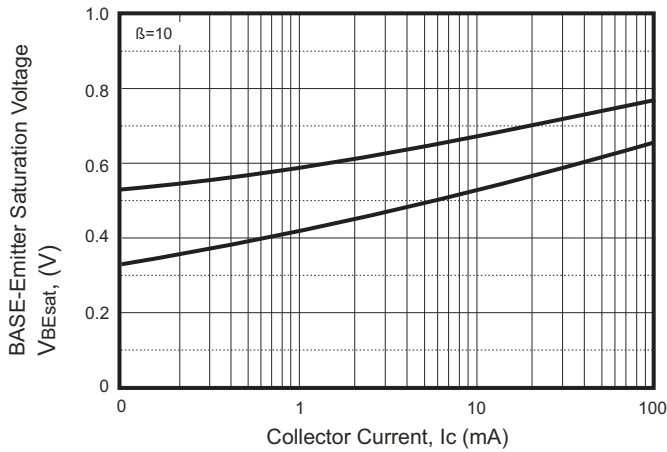

Fig.4 - V_{CEsat} - I_c

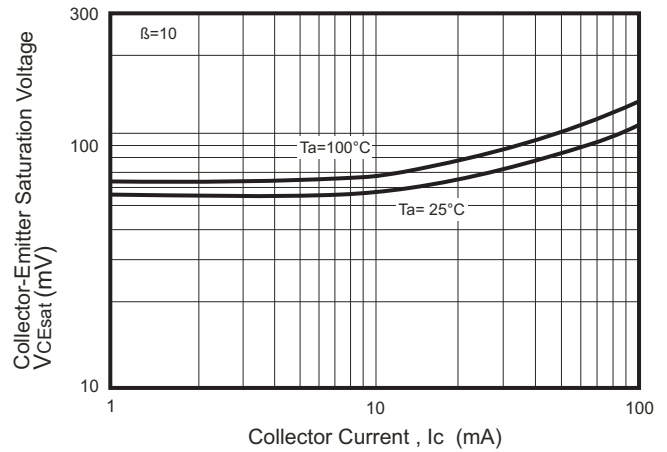

Fig. 5 - C_{ob}/C_{ib} - V_{CB}/V_{EB}

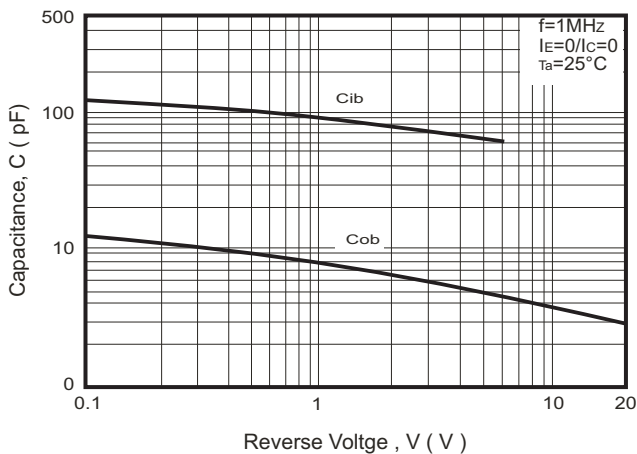
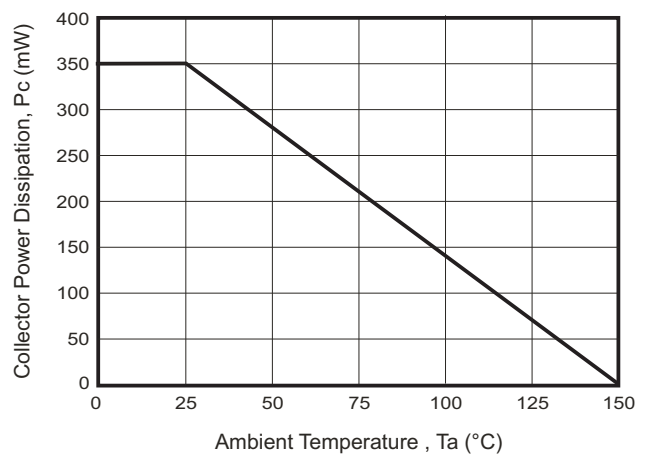
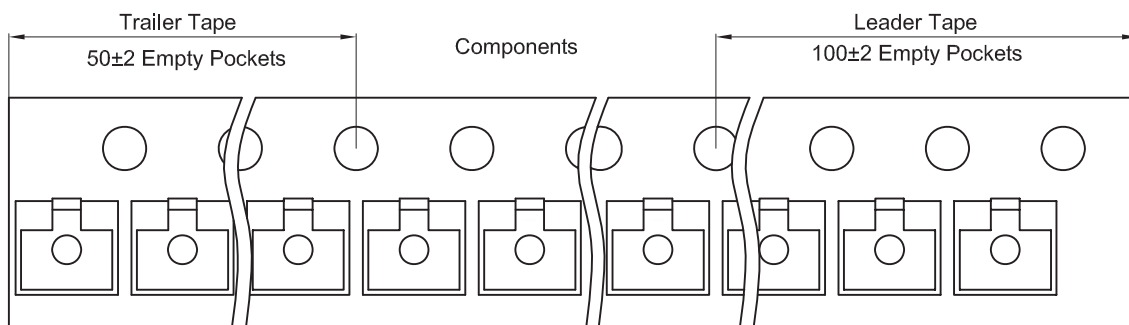
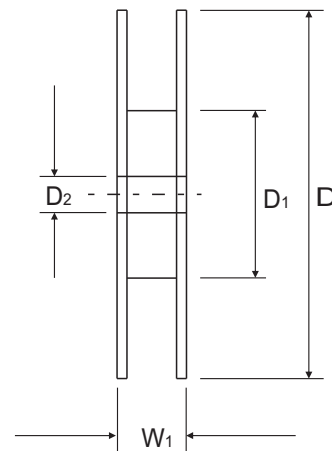
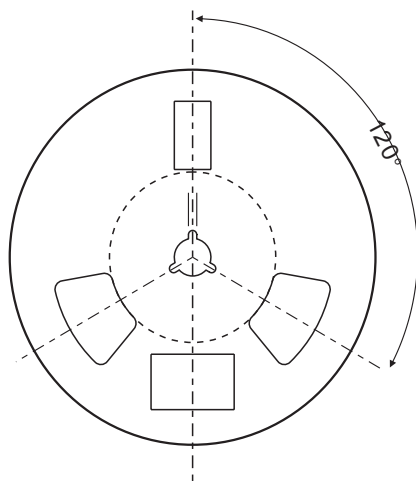
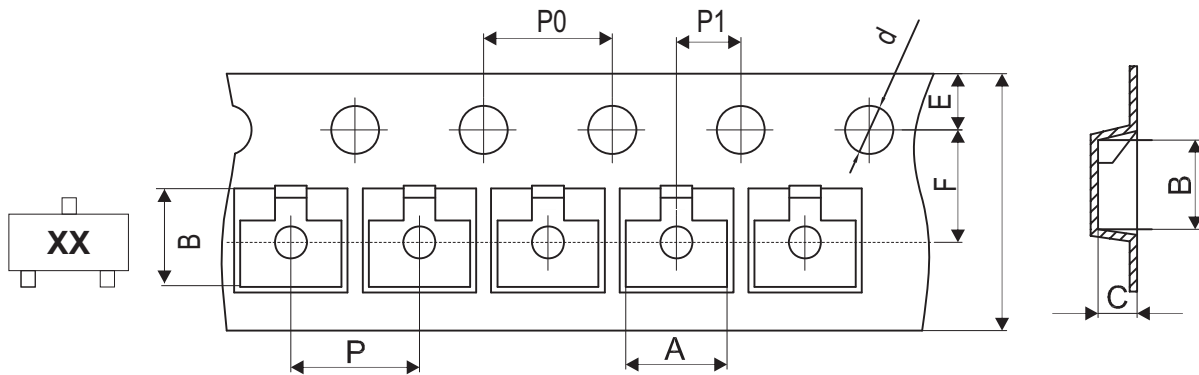

Fig.6 - P_c - T_a



Reel Taping Specification



SOT-23	SYMBOL	A	B	C	d	D	D1	D2
	(mm)	3.15 ± 0.10	2.77 ± 0.10	1.22 ± 0.10	1.50 ± 0.10	178.00 ± 2.00	54.40 ± 1.00	13.00 ± 1.00
	(inch)	0.124 ± 0.004	0.109 ± 0.004	0.048 ± 0.004	0.059 ± 0.004	7.008 ± 0.079	2.142 ± 0.039	0.512 ± 0.039

SOT-23	SYMBOL	E	F	P	P0	P1	W	W1
	(mm)	1.75 ± 0.10	3.50 ± 0.10	4.00 ± 0.10	4.00 ± 0.10	2.00 ± 0.10	8.00 + 0.30 / - 0.10	12.30 ± 1.00
	(inch)	0.069 ± 0.004	0.138 ± 0.004	0.157 ± 0.004	0.157 ± 0.004	0.079 ± 0.004	0.315 + 0.012 / - 0.004	0.484 ± 0.039

Marking Code

Part Number	Marking Code
MMBTA44-G	3D

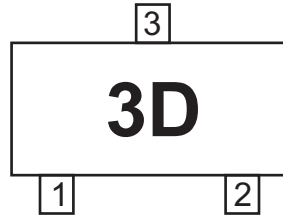

Suggested PAD Layout

SIZE	SOT-23	
	(mm)	(inch)
A	0.60	0.024
B	0.80	0.031
C	1.90	0.075
D	2.02	0.080
E	2.82	0.111

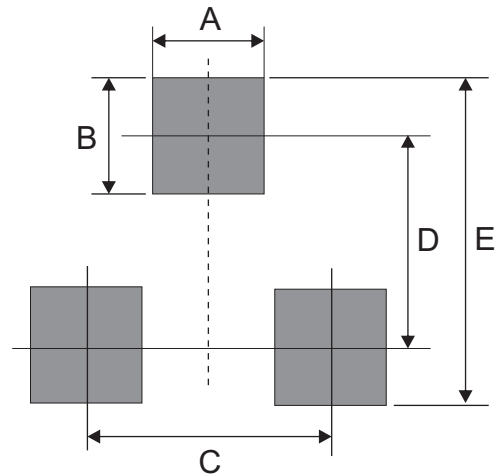

Standard Packaging

Case Type	Qty Per Reel	Reel Size
	(Pcs)	(inch)
SOT-23	3,000	7