

LOC	DIST	REVISIONS					
E	B	P	LTR	DESCRIPTION	DATE	DWN	APVD
		BA		NEW RELEASE	10JULY2010	PT	St.P

FOR FURTHER INFORMATION SEE DATA SHEET FOR  
SERIES S - SMD MOULDED POWER RESISTOR

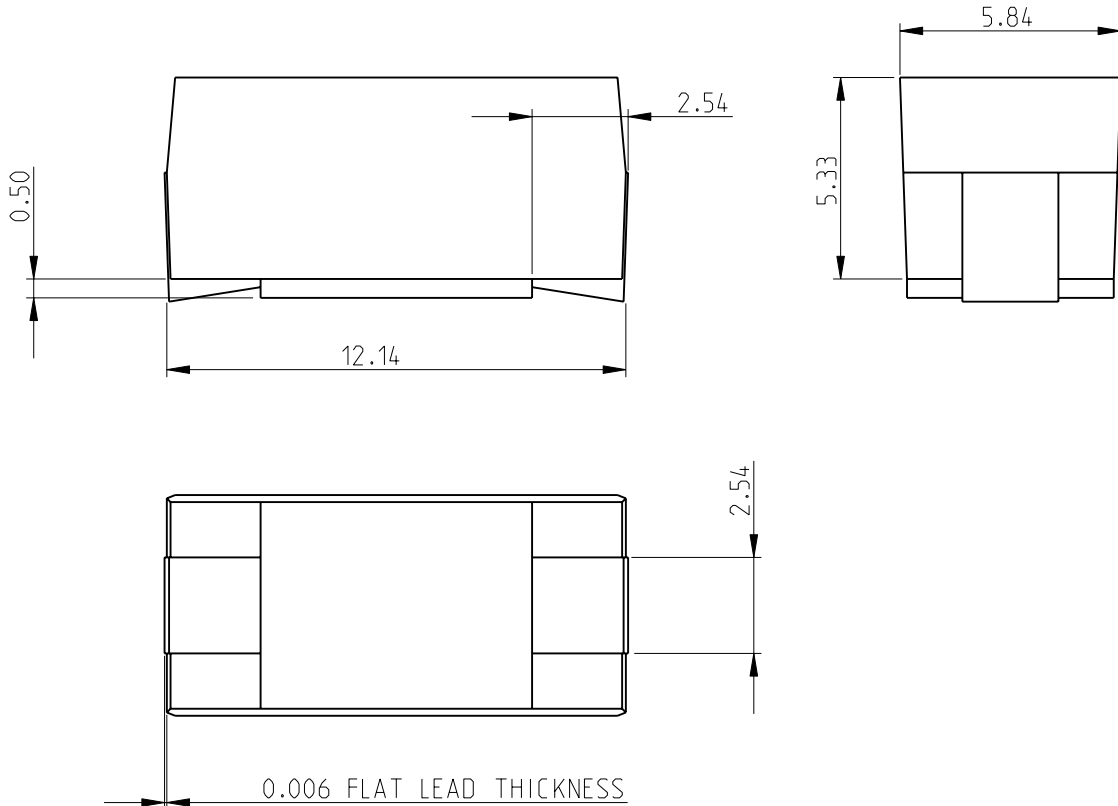

RECOMMENDED LAND PATTERN

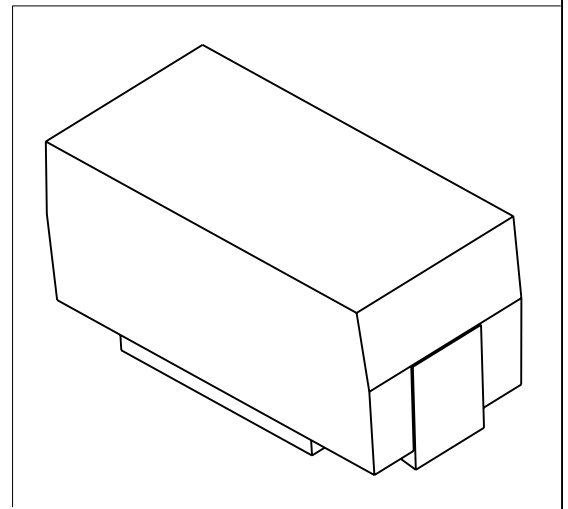
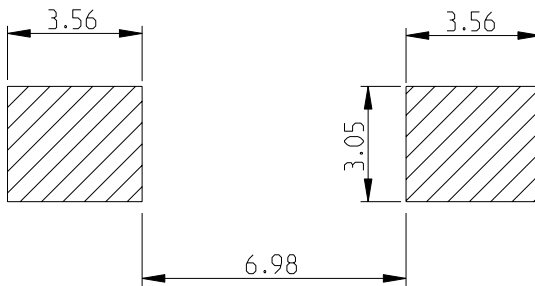

2008

RELEASED FOR PUBLICATION

THIS DRAWING IS UNPUBLISHED.

© COPYRIGHT 2008 BY TYCO ELECTRONICS CORPORATION. ALL RIGHTS RESERVED.

DIMENSIONS: mm	DWN PARUSURAM.T 10JULY2010	MATERIAL -	FINISH -
TOLERANCES UNLESS OTHERWISE SPECIFIED:	CHK ALLAN.P 10JULY2010	Tyco Electronics Corporation Dorcan, Swindon, SN3 5HH	
0 PLC ±0.2 1 PLC ±0.1 2 PLC ± 3 PLC ± 4 PLC ± ANGLES ±5°	APVD STEPHEN.P 10JULY2010		
	PRODUCT SPEC -	NAME SMD MOULDED POWER RESISTOR SERIES SP2	
	APPLICATION SPEC -	SIZE A 4	CAGE CODE 00779
	WEIGHT -	DRAWING NO C-1624300	RESTRICTED TO -
CUSTOMER DRAWING		SCALE 5:1	SHEET 1 OF 1
		REV BA	