

Split Dual SCR POW-R-BLOK™ Modules 20 Amperes/800 Volts

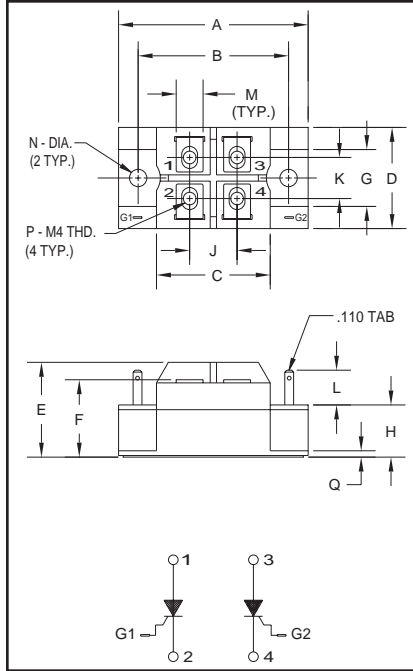

Outline Drawing

Dimension	Inches	Millimeters
A	2.362 Max.	60 Max.
B	1.874	47.6
C	1.417	36
D	1.260 Max.	32 Max.
E	1.181 Max.	30 Max.
F	0.964	24.5
G	0.703	18
H	0.650	16.5
J	0.591	15
K	0.512	13
L	0.433	11
M	0.335	8.5
N	0.216 Dia.	Dia. 5.5
P	M4 Metric	M4
Q	0.079	2



CT230802
Split Dual SCR
POW-R-BLOK™ Modules
20 Amperes/800 Volts

Description:

Powerex Split Dual SCR POW-R-BLOK™ Modules are designed for use in applications requiring control and rectification. The modules are isolated for easy mounting with other components on common heatsinks.

Features:

- Isolated Mounting
- Glass Passivated Chips
- Metal Baseplate
- Low Thermal Impedance
- Four Terminal Flexibility

Applications:

- Battery Supplies
- Contactless Switches
- Furnace Control
- Light Dimmers

Ordering Information:

Select the complete eight digit module part number you desire from the table below.

Example: CT230802 is a 800 Volt, 20 Ampere Split Dual SCR POW-R-BLOK™ Module.

Type	Voltage Volts (x100)	Current Rating Amperes (x10)
CT23	08	02



Powerex, Inc., 200 Hillis Street, Youngwood, Pennsylvania 15697-1800 (724) 925-7272

CT230802

Split Dual SCR POW-R-BLOK™ Modules

20 Amperes/800 Volts

Absolute Maximum Ratings

Characteristics	Symbol	CT230802	Units
Peak Forward Blocking Voltage	V_{DRM}	800	Volts
Transient Peak Forward Blocking Voltage (Non-Repetitive), $t < 5ms$	V_{DSM}	960	Volts
DC Forward Blocking Voltage	$V_{D(DC)}$	640	Volts
Peak Reverse Blocking Voltage	V_{RRM}	800	Volts
Transient Peak Reverse Blocking Voltage (Non-Repetitive), $t < 5ms$	V_{RSM}	960	Volts
DC Reverse Blocking Voltage	$V_{R(DC)}$	640	Volts
RMS On-State Current	$I_T(RSM)$	30	Amperes
Average On-State Current, $T_C = 87^\circ C$	$I_T(AV)$	20	Amperes
Peak One-Cycle Surge (Non-Repetitive) On-State Current (60Hz)	I_{TSM}	400	Amperes
Peak One-Cycle Surge (Non-Repetitive) On-State Current (50Hz)	I_{TSM}	365	Amperes
I^2t (for Fusing), 8.3 milliseconds	I^2t	670	A^2sec
Critical Rate-of-Rise of On-State Current*	di/dt	100	Amperes/ μs
Peak Gate Power Dissipation	P_{GM}	5.0	Watts
Average Gate Power Dissipation	$P_{G(AV)}$	0.5	Watts
Peak Forward Gate Voltage	V_{GFM}	10	Volts
Peak Reverse Gate Voltage	V_{GRM}	5.0	Volts
Peak Forward Gate Current	I_{GFM}	2.0	Amperes
Storage Temperature	T_{STG}	-40 to 125	$^\circ C$
Operating Temperature	T_j	-40 to 125	$^\circ C$
Maximum Mounting Torque M5 Mounting Screw	—	17	in.-lb.
Maximum Mounting Torque M4 Terminal Screw	—	12	lb.-in.
Module Weight (Typical)	—	80	Grams
V Isolation	V_{RMS}	2000	Volts

* $T_j = 125^\circ C$, $I_G = 0.5A$, $V_D = 1/2 V_{DRM}$

Electrical and Thermal Characteristics, $T_j = 25^\circ C$ unless otherwise specified

Characteristics	Symbol	Test Conditions	CT230802	Units
Blocking State Maximums				
Forward Leakage Current, Peak	I_{DRM}	$T_j = 125^\circ C$, $V_{DRM} = \text{Rated}$	4.0	mA
Reverse Leakage Current, Peak	I_{RRM}	$T_j = 125^\circ C$, $V_{RRM} = \text{Rated}$	4.0	mA
Conducting State Maximums				
Peak On-State Voltage	V_{TM}	$I_{TM} = 60A$	1.8	Volts
Switching Minimums				
Critical Rate-of-Rise of Off-State Voltage	dv/dt	$T_j = 125^\circ C$, $V_D = 2/3 V_{DRM}$	500	Volts/ μs
Thermal Maximums				
Thermal Resistance, Junction-to-Case	$R_{\theta(J-C)}$	Per Module	1.0	$^\circ C/Watt$
Thermal Resistance, Case-to-Sink (Lubricated)	$R_{\theta(C-S)}$	Per Module	0.25	$^\circ C/Watt$
Gate Parameters Maximums				
Gate Current-to-Trigger	I_{GT}	$V_D = 6V$, $R_L = 2\Omega$	50	mA
Gate Voltage-to-Trigger	V_{GT}	$V_D = 6V$, $R_L = 2\Omega$	3.0	Volts
Non-Triggering Gate Voltage	V_{GDM}	$T_j = 125^\circ C$, $V_D = 1/2 V_{DRM}$	0.25	Volts

CT230802
Split Dual SCR POW-R-BLOK™ Modules
 20 Amperes/800 Volts

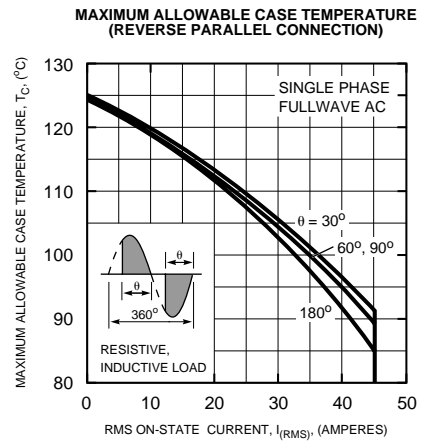
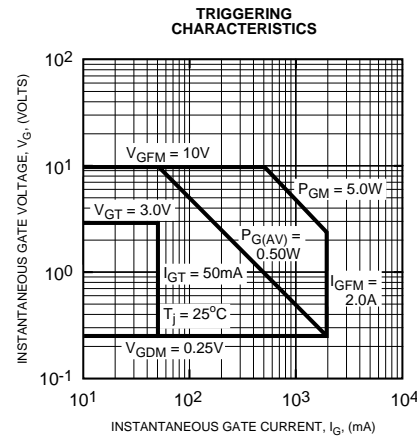
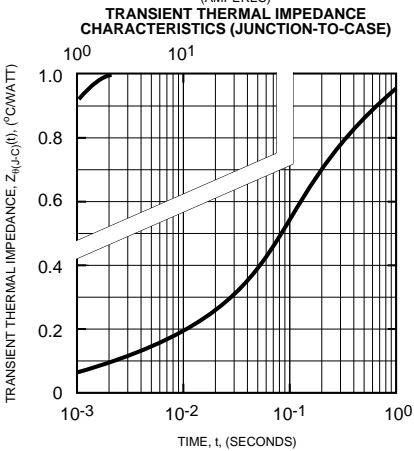
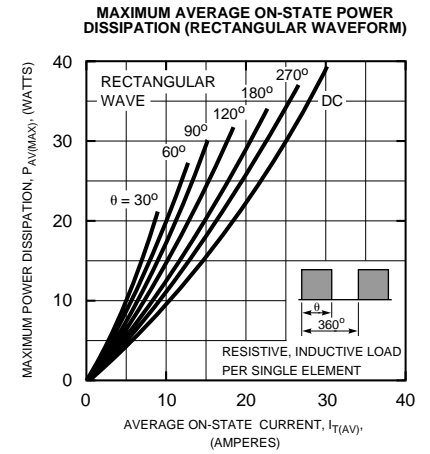
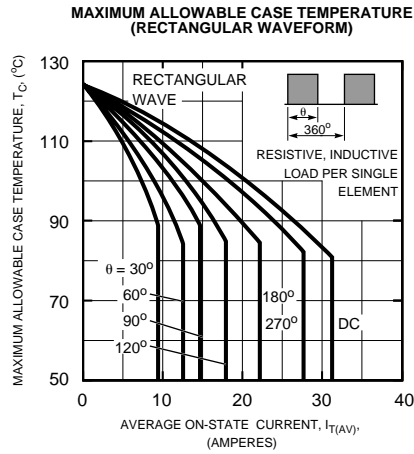
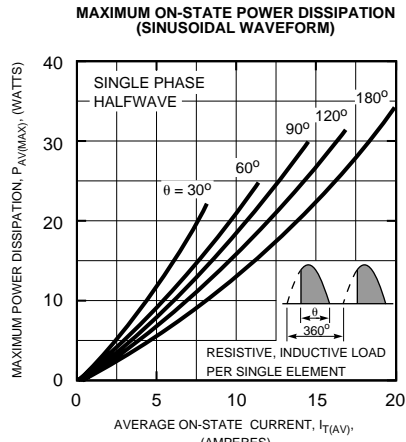
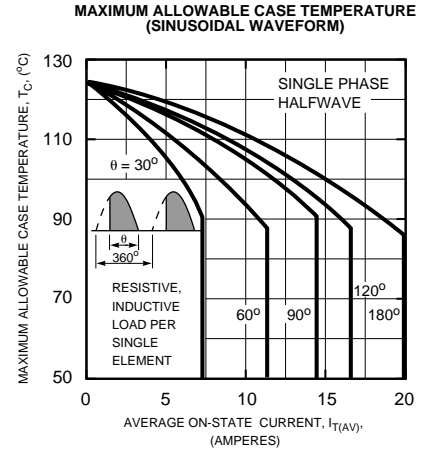
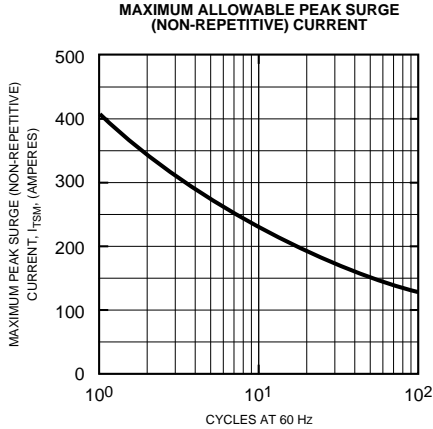
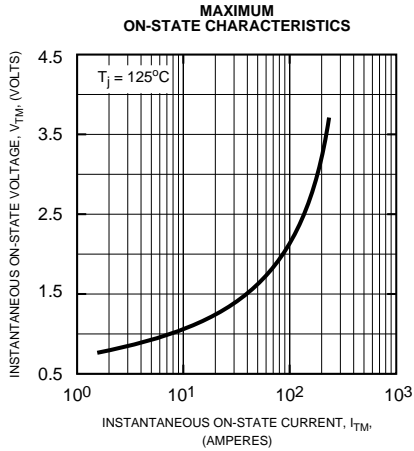

CT230802
Split Dual SCR POW-R-BLOK™ Modules
 20 Amperes/800 Volts

MAXIMUM ON-STATE POWER DISSIPATION (REVERSE PARALLEL CONNECTION)

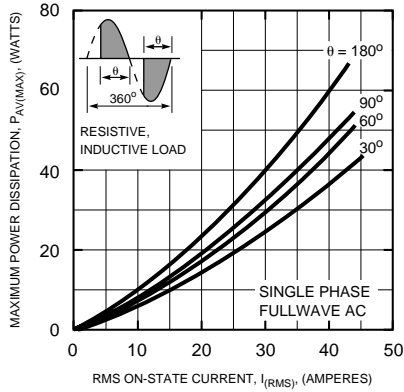

MAXIMUM ALLOWABLE CASE TEMPERATURE (SINGLE PHASE BRIDGE CONNECTION)

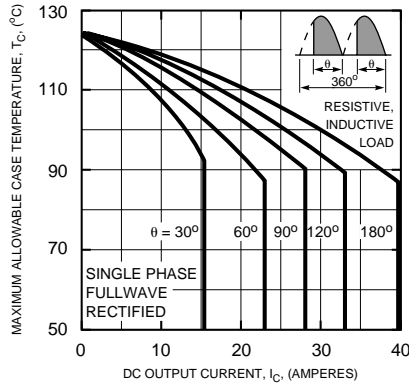

MAXIMUM ON-STATE POWER DISSIPATION (SINGLE PHASE BRIDGE CONNECTION)

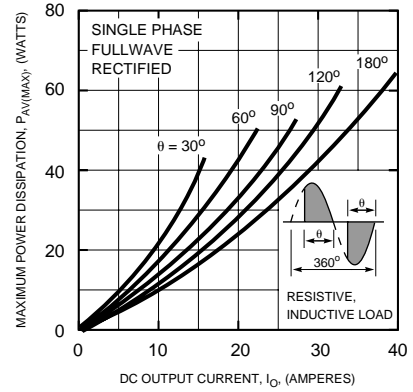

MAXIMUM ALLOWABLE CASE TEMPERATURE (THREE PHASE BRIDGE CONNECTION)

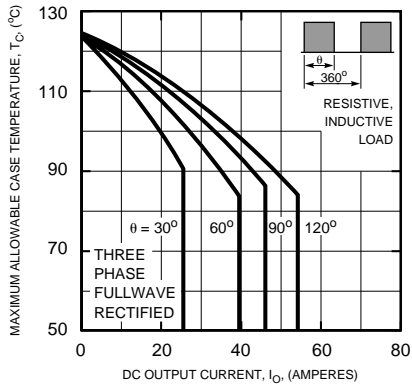

MAXIMUM ON-STATE POWER DISSIPATION (THREE PHASE BRIDGE CONNECTION)

