

IRF7809AVPbF

- N-Channel Application-Specific MOSFETs
- Ideal for CPU Core DC-DC Converters
- Low Conduction Losses
- Low Switching Losses
- Minimizes Parallel MOSFETs for high current applications
- 100% Tested for Rg
- Lead-Free

Description

This new device employs advanced HEXFET Power MOSFET technology to achieve an unprecedented balance of on-resistance and gate charge. The reduced conduction and switching losses make it ideal for high efficiency DC-DC converters that power the latest generation of microprocessors.

The IRF7809AV has been optimized for all parameters that are critical in synchronous buck converters including $R_{DS(on)}$, gate charge and Cdv/dt-induced turn-on immunity. The IRF7809AV offers particularly low $R_{DS(on)}$ and high Cdv/dt immunity for synchronous FET applications.

The package is designed for vapor phase, infra-red, convection, or wave soldering techniques. Power dissipation of greater than 2W is possible in a typical PCB mount application.

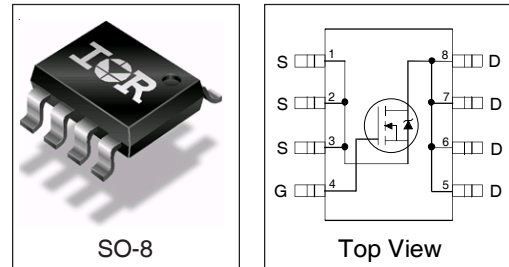

DEVICE CHARACTERISTICS^⑤

	IRF7809AV
$R_{DS(on)}$	7.0mΩ
Q_G	41nC
Q_{sw}	14nC
Q_{oss}	30nC

Absolute Maximum Ratings

Parameter	Symbol	IRF7809A V	Units
Drain-Source Voltage	V_{DS}	30	V
Gate-Source Voltage	V_{GS}	±12	
Continuous Drain or Source Current ($V_{GS} \geq 4.5V$)	I_D	$T_A = 25^\circ C$	13.3
		$T_L = 90^\circ C$	14.6
Pulsed Drain Current ^①	I_{DM}	100	A
Power Dissipation	P_D	$T_A = 25^\circ C$	2.5
		$T_L = 90^\circ C$	3.0
Junction & Storage Temperature Range	T_J, T_{STG}	-55 to 150	°C
Continuous Source Current (Body Diode)	I_S	2.5	A
Pulsed Source Current ^①	I_{SM}	50	

Thermal Resistance

Parameter		Max.	Units
Maximum Junction-to-Ambient ^③	$R_{\theta JA}$	50	°C/W
Maximum Junction-to-Lead	$R_{\theta JL}$	20	°C/W

IRF7809AVPbF

International
IR Rectifier

Electrical Characteristics

Parameter		Min	Typ	Max	Units	Conditions
Drain-to-Source Breakdown Voltage	BV_{DSS}	30	–	–	V	$V_{GS} = 0V, I_D = 250\mu A$
Static Drain-Source on Resistance	$R_{DS(on)}$		7.0	9.0	m Ω	$V_{GS} = 4.5V, I_D = 15A$ Ⓞ
Gate Threshold Voltage	$V_{GS(th)}$	1.0			V	$V_{DS} = V_{GS}, I_D = 250\mu A$
Drain-Source Leakage Current	I_{DSS}			30	μA	$V_{DS} = 24V, V_{GS} = 0$
				150		$V_{DS} = 24V, V_{GS} = 0,$ $T_j = 100^\circ C$
Gate-Source Leakage Current*	I_{GSS}			± 100	nA	$V_{GS} = \pm 12V$
Total Gate Chg Cont FET	Q_G		41	62	nC	$V_{GS}=5V, I_D=15A, V_{DS}=20V$
Total Gate Chg Sync FET	Q_G		36	54		$V_{GS} = 5V, V_{DS} < 100mV$
Pre-Vth Gate-Source Charge	Q_{GS1}		7.0			$V_{DS} = 20V, I_D = 15A$
Post-Vth Gate-Source Charge	Q_{GS2}		2.3			
Gate to Drain Charge	Q_{GD}		12			$I_D=15A, V_{DS}=16V$
Switch Chg($Q_{gs2} + Q_{gd}$)	Q_{sw}		14	21		
Output Charge*	Q_{oss}		30	45		$V_{DS} = 16V, V_{GS} = 0$
Gate Resistance	R_G		1.5	3.0		Ω
Turn-on Delay Time	$t_{d(on)}$		14		ns	$V_{DD} = 16V, I_D = 15A$ $V_{GS} = 5V$ Clamped Inductive Load
Rise Time	t_r		36			
Turn-off Delay Time	$t_{d(off)}$		96			
Fall Time	t_f		10			
Input Capacitance	C_{iss}	–	3780	–	pF	$V_{DS} = 16V, V_{GS} = 0$
Output Capacitance	C_{oss}	–	1060	–		
Reverse Transfer Capacitance	C_{rss}	–	130	–		

Source-Drain Rating & Characteristics

Parameter		Min	Typ	Max	Units	Conditions
Diode Forward Voltage*	V_{SD}			1.3	V	$I_S = 15A$ Ⓞ, $V_{GS} = 0V$
Reverse Recovery ChargeⓄ	Q_{rr}		120		nC	$di/dt \sim 700A/\mu s$ $V_{DS} = 16V, V_{GS} = 0V, I_S = 15A$
Reverse Recovery Charge (with Parallel Schottky)Ⓞ	$Q_{rr(s)}$		150		nC	$di/dt = 700A/\mu s$ (with 10BQ040) $V_{DS} = 16V, V_{GS} = 0V, I_S = 15A$

- Notes:**
- ① Repetitive rating; pulse width limited by max. junction temperature.
 - ② Pulse width $\leq 400 \mu s$; duty cycle $\leq 2\%$.
 - ③ When mounted on 1 inch square copper board, $t < 10$ sec.
 - ④ Typ = measured - Q_{oss}
 - ⑤ Typical values measured at $V_{GS} = 4.5V, I_F = 15A$.

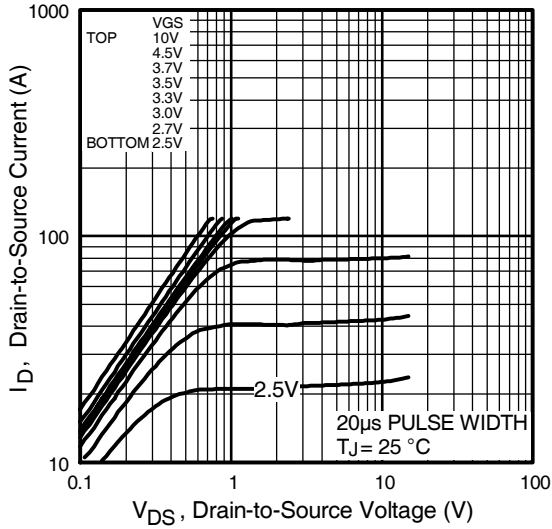

Fig 1. Typical Output Characteristics

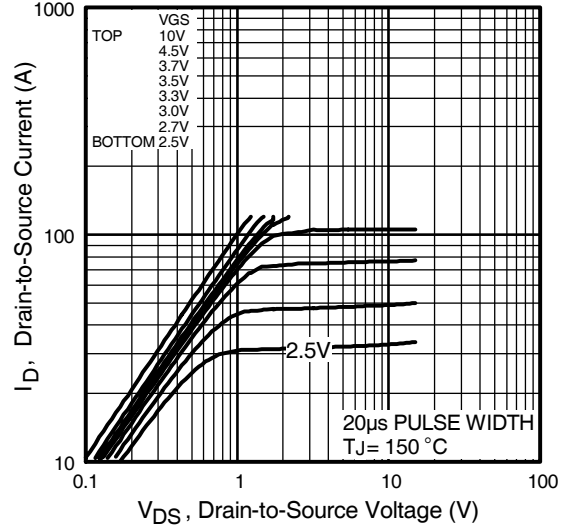

Fig 2. Typical Output Characteristics

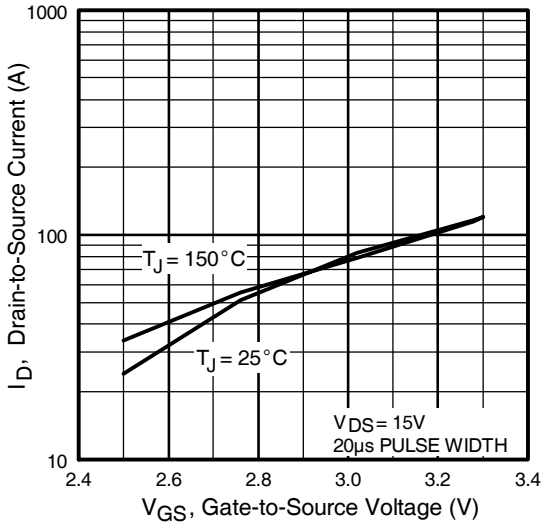

Fig 3. Typical Transfer Characteristics

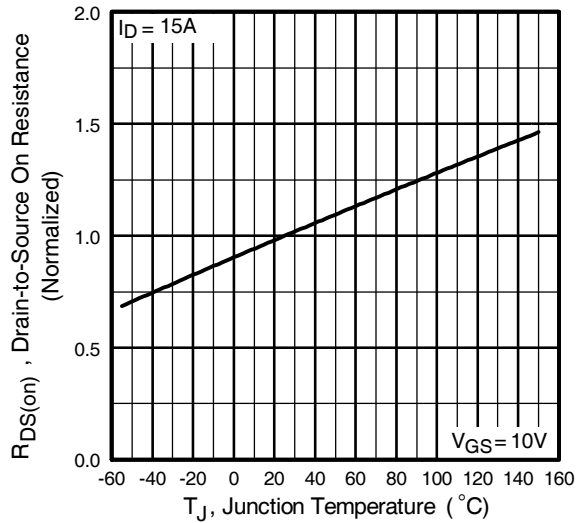

Fig 4. Normalized On-Resistance Vs. Temperature

IRF7809AVPbF

International
IR Rectifier

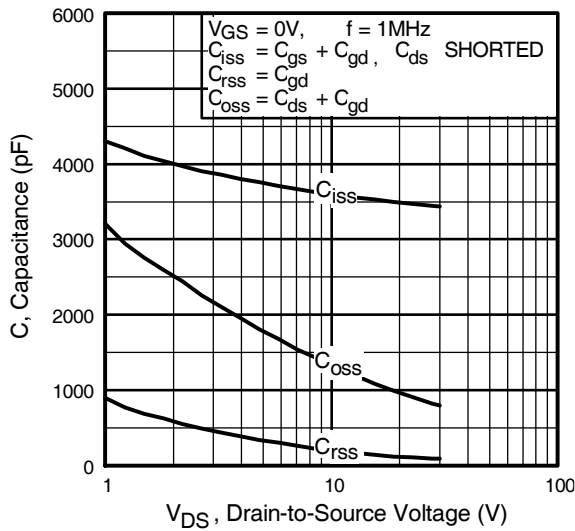

Fig 5. Typical Capacitance Vs. Drain-to-Source Voltage

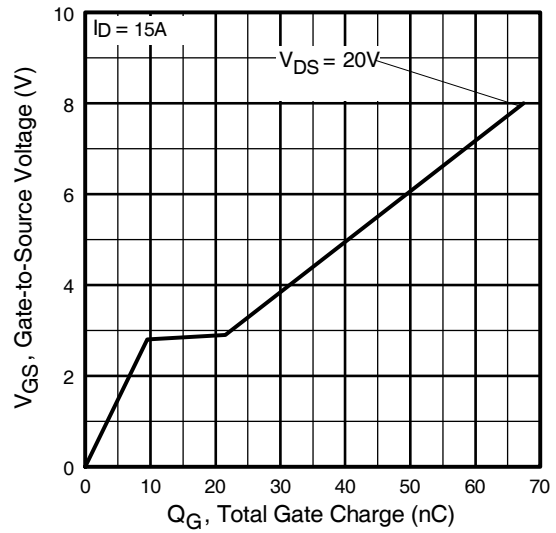

Fig 6. Typical Gate Charge Vs. Gate-to-Source Voltage

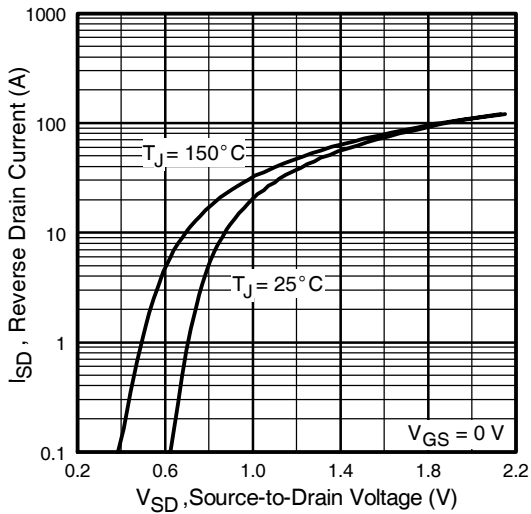

Fig 7. Typical Source-Drain Diode Forward Voltage

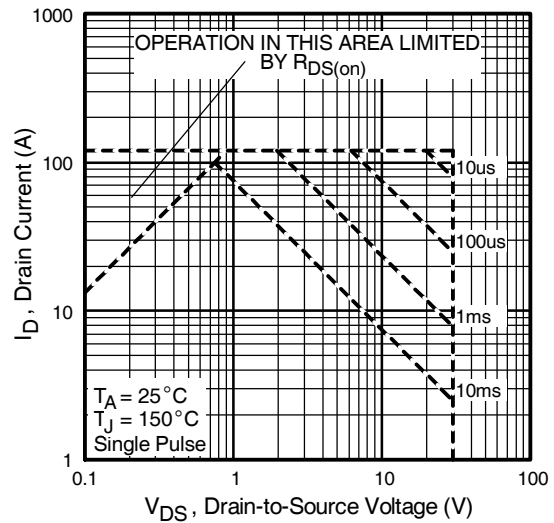

Fig 8. Maximum Safe Operating Area

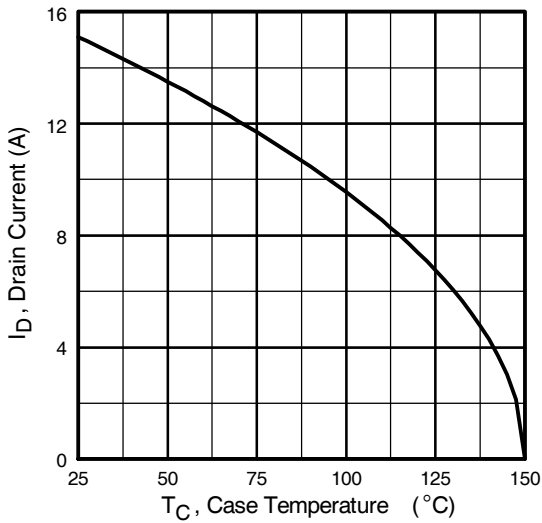

Fig 9. Maximum Drain Current Vs. Case Temperature

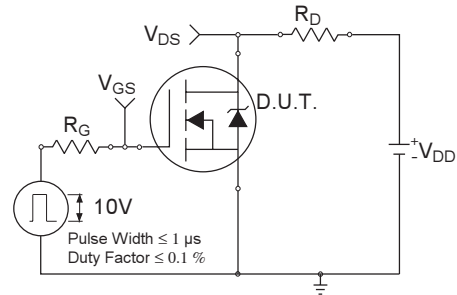

Fig 10a. Switching Time Test Circuit

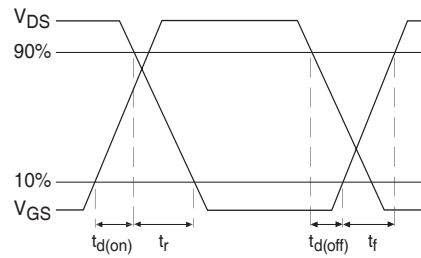

Fig 10b. Switching Time Waveforms

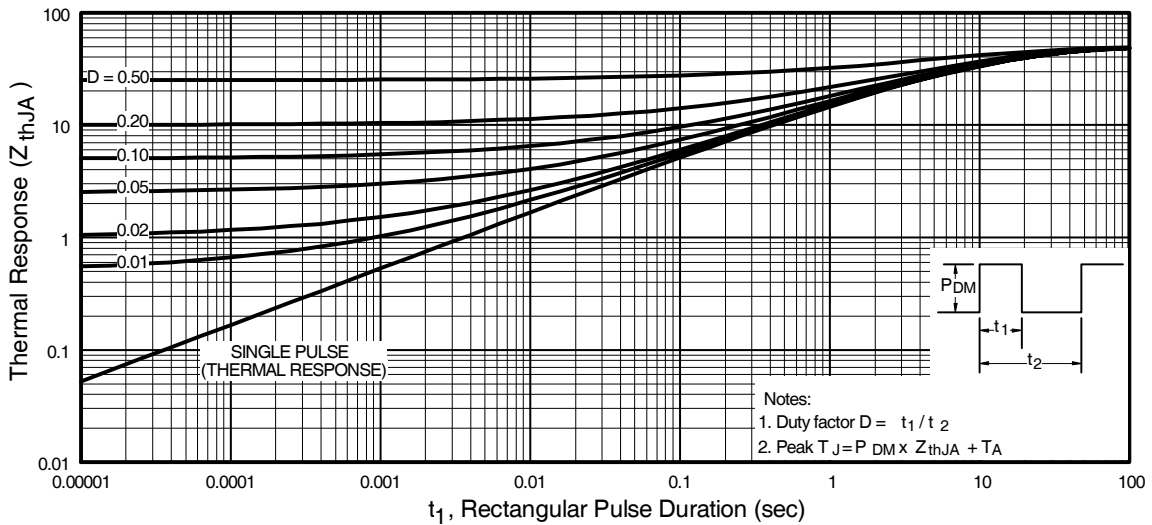

Fig 11. Maximum Effective Transient Thermal Impedance, Junction-to-Ambient

IRF7809AVPbF

International
IR Rectifier

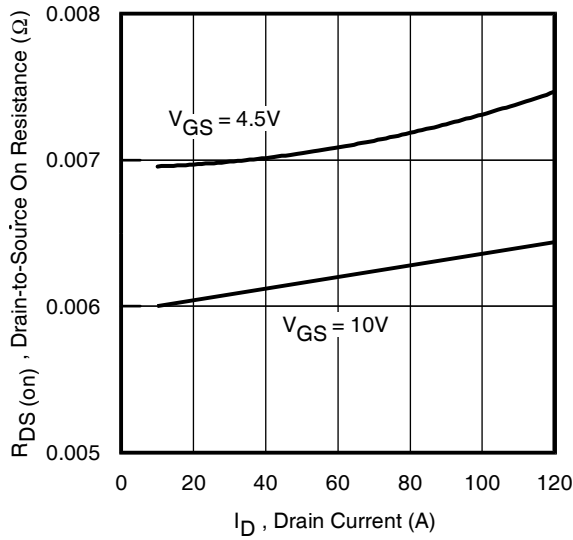

Fig 12. On-Resistance Vs. Drain Current

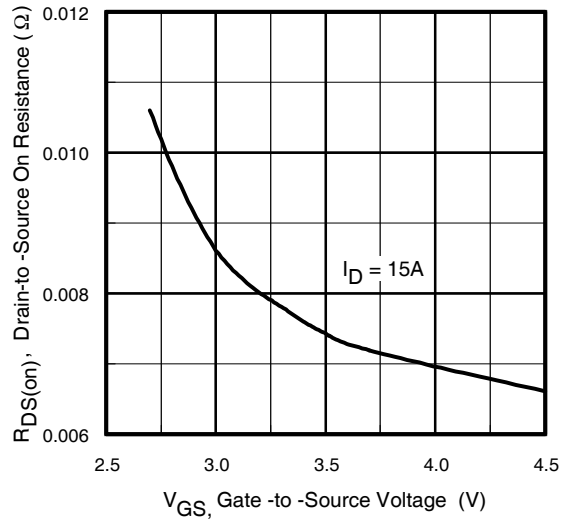

Fig 13. On-Resistance Vs. Gate Voltage

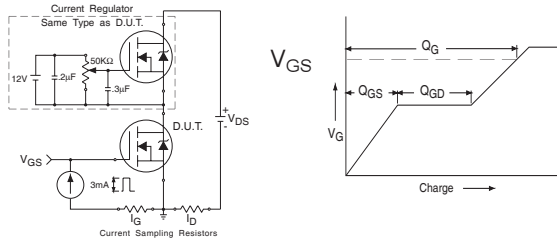

Fig 13a&b. Basic Gate Charge Test Circuit and Waveform

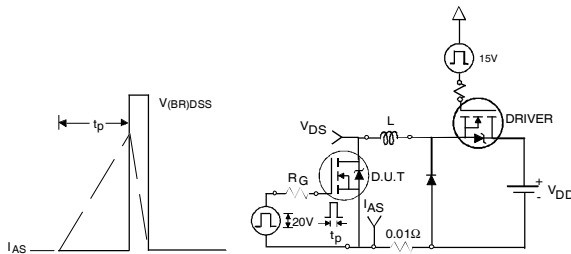

Fig 14a&b. Unclamped Inductive Test circuit and Waveforms

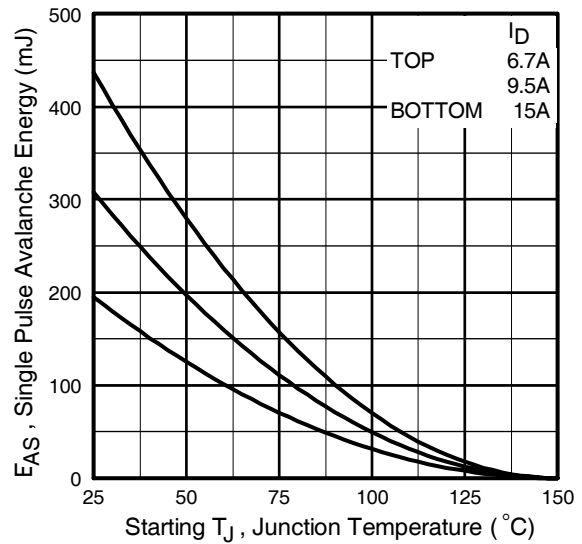
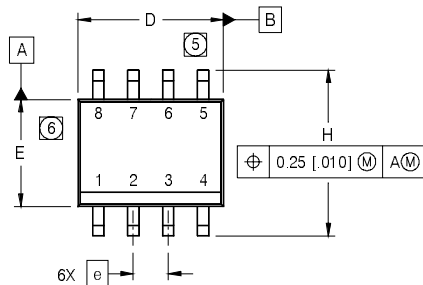

Fig 14c. Maximum Avalanche Energy Vs. Drain Current

SO-8 Package Outline

Dimensions are shown in millimeters (inches)



DIM	INCHES		MILLIMETERS	
	MIN	MAX	MIN	MAX
A	.0532	.0688	1.35	1.75
A1	.0040	.0098	0.10	0.25
b	.013	.020	0.33	0.51
c	.0075	.0098	0.19	0.25
D	.189	.1968	4.80	5.00
E	.1497	.1574	3.80	4.00
e	.050 BASIC		1.27 BASIC	
e1	.025 BASIC		0.635 BASIC	
H	.2284	.2440	5.80	6.20
K	.0099	.0196	0.25	0.50
L	.016	.050	0.40	1.27
y	0°	8°	0°	8°

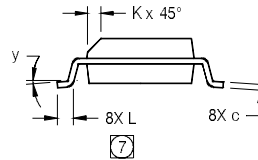
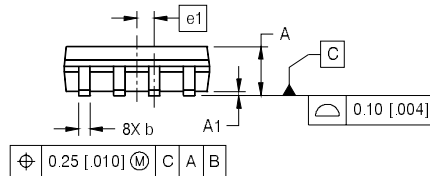

NOTES:

- DIMENSIONING & TOLERANCING PER ASME Y14.5M-1994.
- CONTROLLING DIMENSION: MILLIMETER
- DIMENSIONS ARE SHOWN IN MILLIMETERS [INCHES].
- OUTLINE CONFORMS TO JEDEC OUTLINE MS-012AA.
- (5)** DIMENSION DOES NOT INCLUDE MOLD PROTRUSIONS. MOLD PROTRUSIONS NOT TO EXCEED 0.15 [0.006].
- (6)** DIMENSION DOES NOT INCLUDE MOLD PROTRUSIONS. MOLD PROTRUSIONS NOT TO EXCEED 0.25 [0.010].
- (7)** DIMENSION IS THE LENGTH OF LEAD FOR SOLDERING TO A SUBSTRATE.

FOOTPRINT

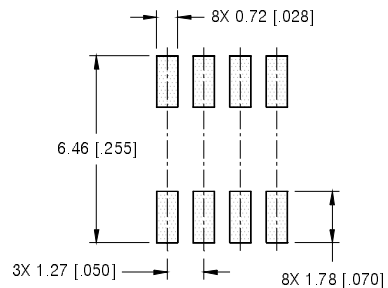

SO-8 Part Marking Information

EXAMPLE: THIS IS AN IRF7101 (MOSFET)

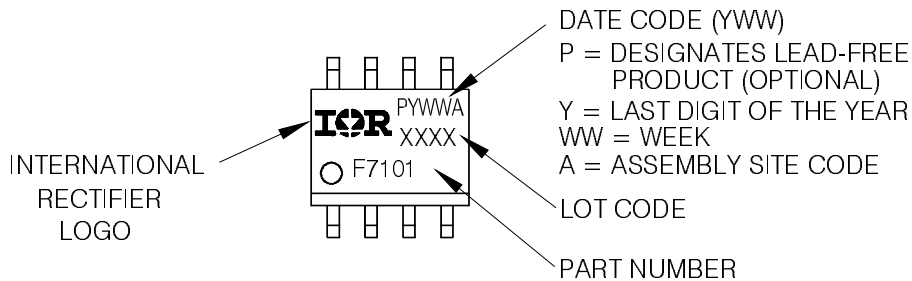

IRF7809AVPbF

International
IR Rectifier

SO-8 Tape and Reel

Dimensions are shown in millimeters (inches)

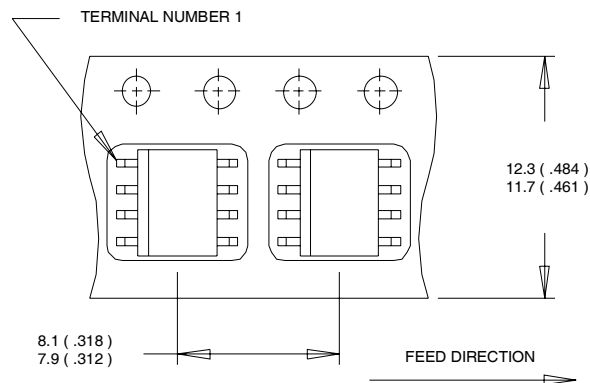

NOTES:

1. CONTROLLING DIMENSION : MILLIMETER.
2. ALL DIMENSIONS ARE SHOWN IN MILLIMETERS(INCHES).
3. OUTLINE CONFORMS TO EIA-481 & EIA-541.

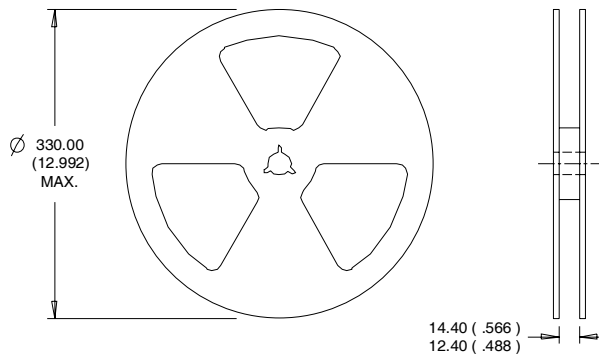

NOTES :

1. CONTROLLING DIMENSION : MILLIMETER.
2. OUTLINE CONFORMS TO EIA-481 & EIA-541.

Data and specifications subject to change without notice.
This product has been designed and qualified for the Consumer market.
Qualifications Standards can be found on IR's Web site.

International
IR Rectifier

IR WORLD HEADQUARTERS: 233 Kansas St., El Segundo, California 90245, USA Tel: (310) 252-7105
TAC Fax: (310) 252-7903

Visit us at www.irf.com for sales contact information.08/05

www.irf.com