

Description

Thanks to a junction temperature T_j up to 150 °C and a non-isolated TO-220 package, the TN1610H-6T offers high thermal performance operation up to 16 A rms.

The trade-off between the device's noise immunity ($dV/dt = 1 \text{ kV}/\mu\text{s}$), its gate triggering current ($I_{GT} = 10 \text{ mA}$) and its turn-on current rise ($dI/dt = 100 \text{ A}/\mu\text{s}$) allows the design of robust and compact control circuits for voltage regulators in motorbikes and industrial drives, overvoltage crowbar protection, motor control circuits in power tools and kitchen appliances and inrush current limiting circuits.

Table 1. Device summary

Order code	Package	V_{DRM}/V_{RRM}	I_{GT}
TN1610H-6T	TO-220AB	600 V	10 mA

Features

- High junction temperature: $T_j = 150 \text{ °C}$
- High noise immunity $dV/dt = 1000 \text{ V}/\mu\text{s}$ up to 150 °C
- Gate triggering current $I_{GT} = 10 \text{ mA}$
- Blocking voltage $V_{DRM}/V_{RRM} = 600 \text{ V}$
- High turn on current rise $dI/dt: 100 \text{ A}/\mu\text{s}$
- ECOPACK[®]2 compliant component

Applications

- Voltage regulator circuits for motorbikes
- Inrush current limiting circuits
- Motor control circuits and starters
- Light dimmers
- Solid state relays

1 Characteristics

Table 2. Absolute ratings

Symbol	Parameter		Value	Unit	
$I_{T(RMS)}$	On-state rms current (180° conduction angle)		$T_c = 133\text{ °C}$	16	A
$I_{T(AV)}$	Average on-state current (180° conduction angle)		$T_c = 133\text{ °C}$	10	A
			$T_c = 138\text{ °C}$	8	
			$T_c = 142\text{ °C}$	6	
I_{TSM}	Non repetitive surge peak on-state current (T_j initial = 25 °C)		$t = 8.3\text{ ms}$	153	A
			$t = 10\text{ ms}$	140	
I^2t	I^2t value for fusing (T_j initial = 25 °C)		$t_p = 10\text{ ms}$	98	A ² s
dI/dt	Critical rate of rise of on-state current $I_G = 2 \times I_{GT}$, $t_r \leq 100\text{ ns}$, $T_j = 25\text{ °C}$		$F = 60\text{ Hz}$	100	A/μs
V_{DRM} , V_{RRM}	Repetitive peak off-state voltage			600	V
I_{GM}	Peak gate current	$t_p = 20\text{ μs}$	$T_j = 150\text{ °C}$	4	A
$P_{G(AV)}$	Average gate power dissipation		$T_j = 150\text{ °C}$	1	W
T_{stg} T_j	Storage junction temperature range			- 40 to + 150	°C
	Operating junction temperature range			- 40 to + 150	
T_L	Maximum lead temperature for soldering during 10 s			260	°C

Table 3. Electrical characteristics ($T_j = 25\text{ °C}$, unless otherwise specified)

Symbol	Test conditions		Value	Unit	
I_{GT}	$V_D = 12\text{ V}$, $R_L = 33\text{ Ω}$		Typ.	4.5	mA
			Max.	10	
V_{GT}	$V_D = 12\text{ V}$, $R_L = 33\text{ Ω}$		Max.	1.3	V
V_{GD}	$V_D = V_{DRM}$, $R_L = 3.3\text{ kΩ}$	$T_j = 150\text{ °C}$	Min.	0.2	V
I_H	$I_T = 500\text{ mA}$, gate open		Max.	30	mA
I_L	$I_G = 1.2 \times I_{GT}$		Max.	60	mA
dV/dt	$V_D = 402\text{ V}$, gate open	$T_j = 150\text{ °C}$	Min.	1000	V/μs
t_{gt}	$I_T = 32\text{ A}$, $V_D = 600\text{ V}$, $I_G = 100\text{ mA}$, (dI_G/dt) _{max} = 0.2 A/μs		Typ	1.9	μs
t_q	$V_D = 402\text{ V}$, $V_R = 25\text{ V}$, $I_T = 16\text{ A}$, (dI_G/dt) _{max} = 30 A/μs, $dV_D/dt = 40\text{ V/μs}$	$T_j = 150\text{ °C}$	Typ	70	μs

Table 4. Static characteristics

Symbol	Test conditions			Value	Unit
V_{TM}	$I_{TM} = 32 \text{ A}$, $t_p = 380 \mu\text{s}$	$T_j = 25 \text{ }^\circ\text{C}$	Max.	1.6	V
V_{t0}	Threshold voltage	$T_j = 150 \text{ }^\circ\text{C}$	Max.	0.82	V
R_d	Dynamic resistance	$T_j = 150 \text{ }^\circ\text{C}$	Max.	25	m Ω
I_{DRM} , I_{RRM}	$V_D = V_{DRM}$, $V_R = V_{RRM}$	$T_j = 25 \text{ }^\circ\text{C}$	Max.	5	μA
		$T_j = 150 \text{ }^\circ\text{C}$		1.5	mA

Table 5. Thermal resistance

Symbol	Parameter	Value	Unit
$R_{th(j-c)}$	Junction to case (AC)	1.1	$^\circ\text{C/W}$
$R_{th(j-a)}$	Junction to ambient (DC)	60	$^\circ\text{C/W}$

Figure 1. Maximum power dissipation versus average on-state current

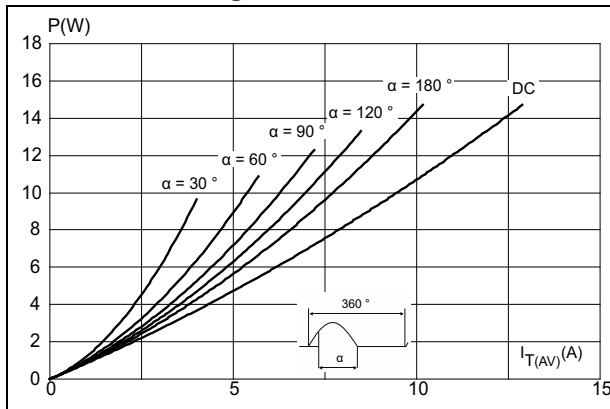

Figure 2. Average and DC on-state current versus case temperature

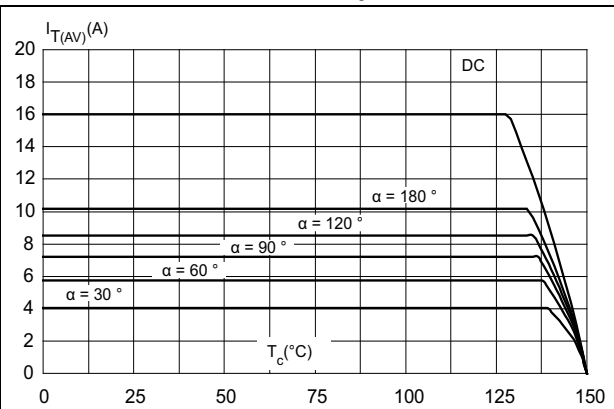

Figure 3. Average and DC on-state current versus ambient temperature

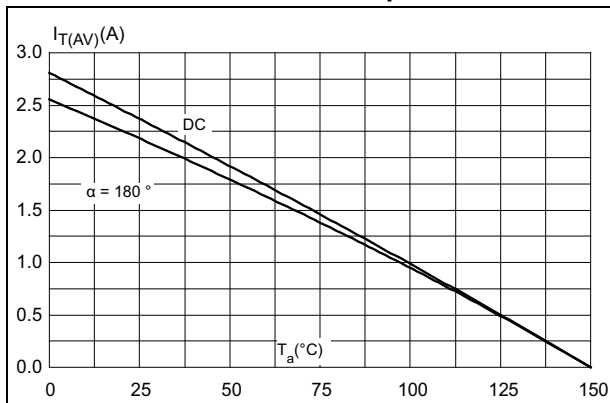

Figure 4. Relative variation of thermal impedance versus pulse duration

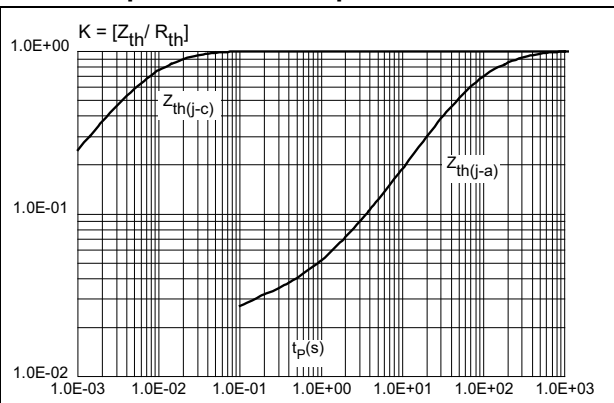

Figure 5. Relative variation of gate triggering current and gate voltage versus junction temperature (typical values)

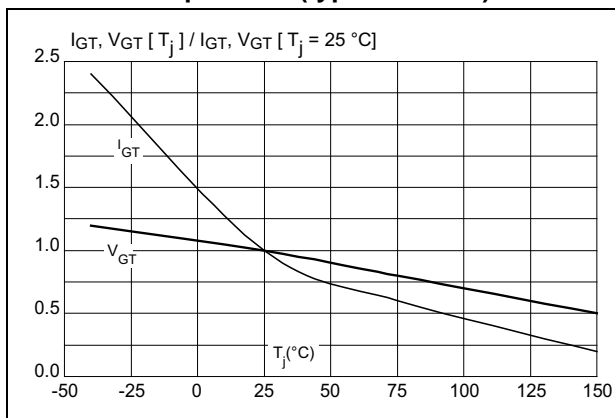

Figure 6. Relative variation of holding current and latching current versus junction temperature (typical values)

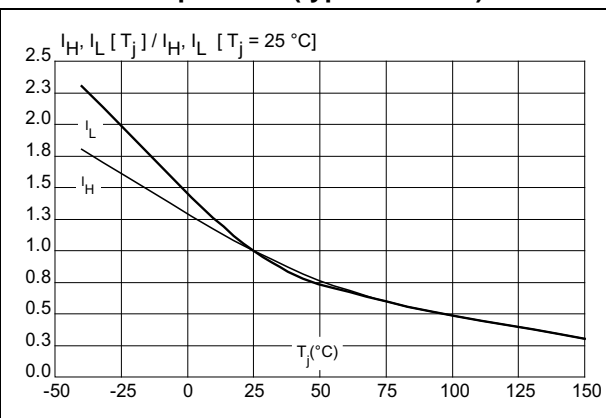

Figure 7. Relative variation of static dV/dt immunity versus junction temperature (typical values)

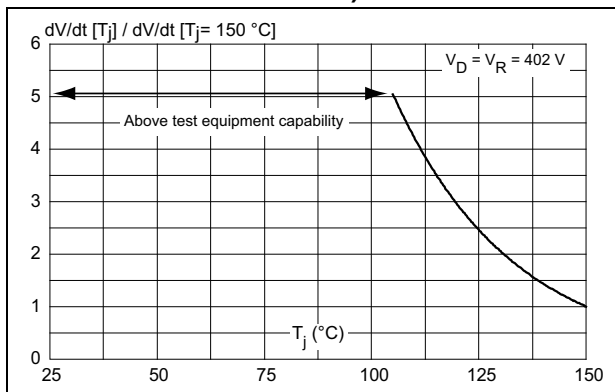

Figure 8. Surge peak on-state current versus number of cycles

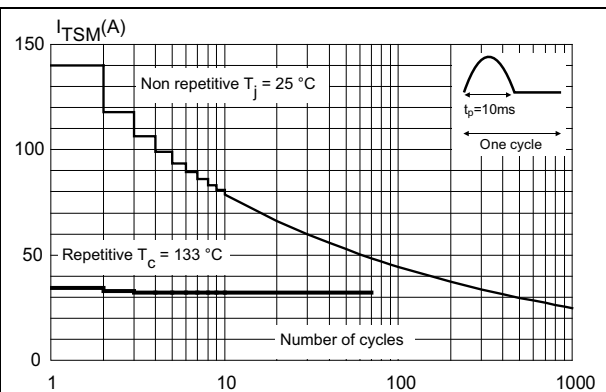

Figure 9. Non-repetitive surge peak on-state current for a sinusoidal pulse ($t_p < 10\text{ ms}$)

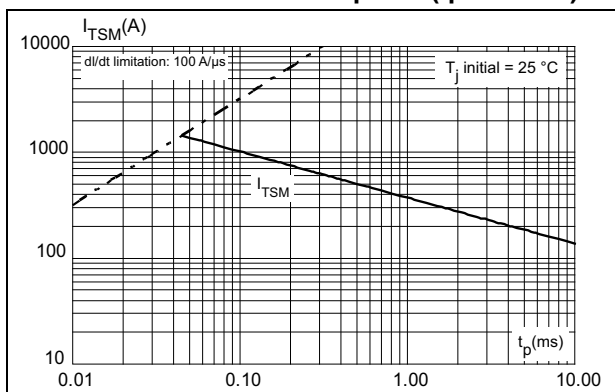

Figure 10. On-state characteristics (maximum values)

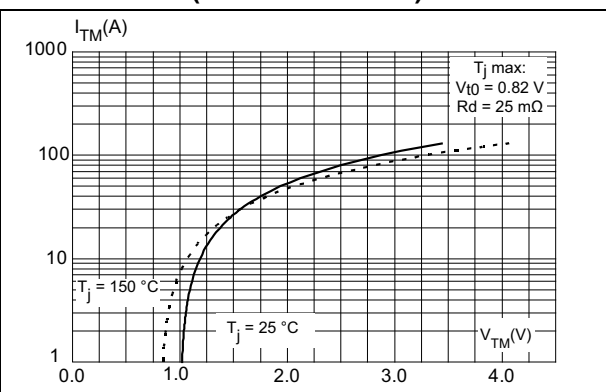
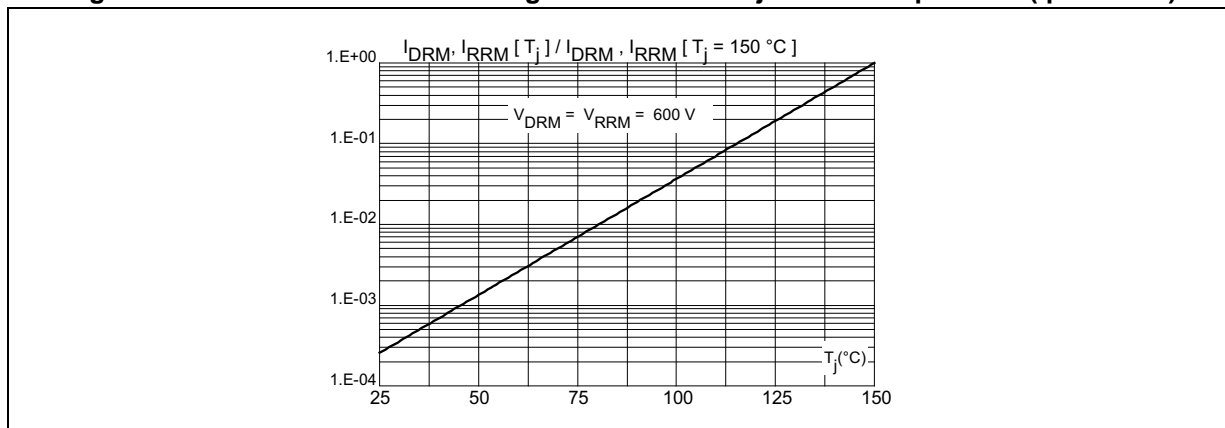

Figure 11. Relative variation of leakage current versus junction temperature (tp < 10 ms)



2 Package information

- Epoxy meets UL94, V0
- Lead-free package
- Halogen free molding compound
- Recommended torque: 0.4 to 0.6 N·m

In order to meet environmental requirements, ST offers these devices in different grades of ECOPACK® packages, depending on their level of environmental compliance. ECOPACK® specifications, grade definitions and product status are available at: www.st.com. ECOPACK® is an ST trademark.

Figure 12. TO-220AB dimension definitions

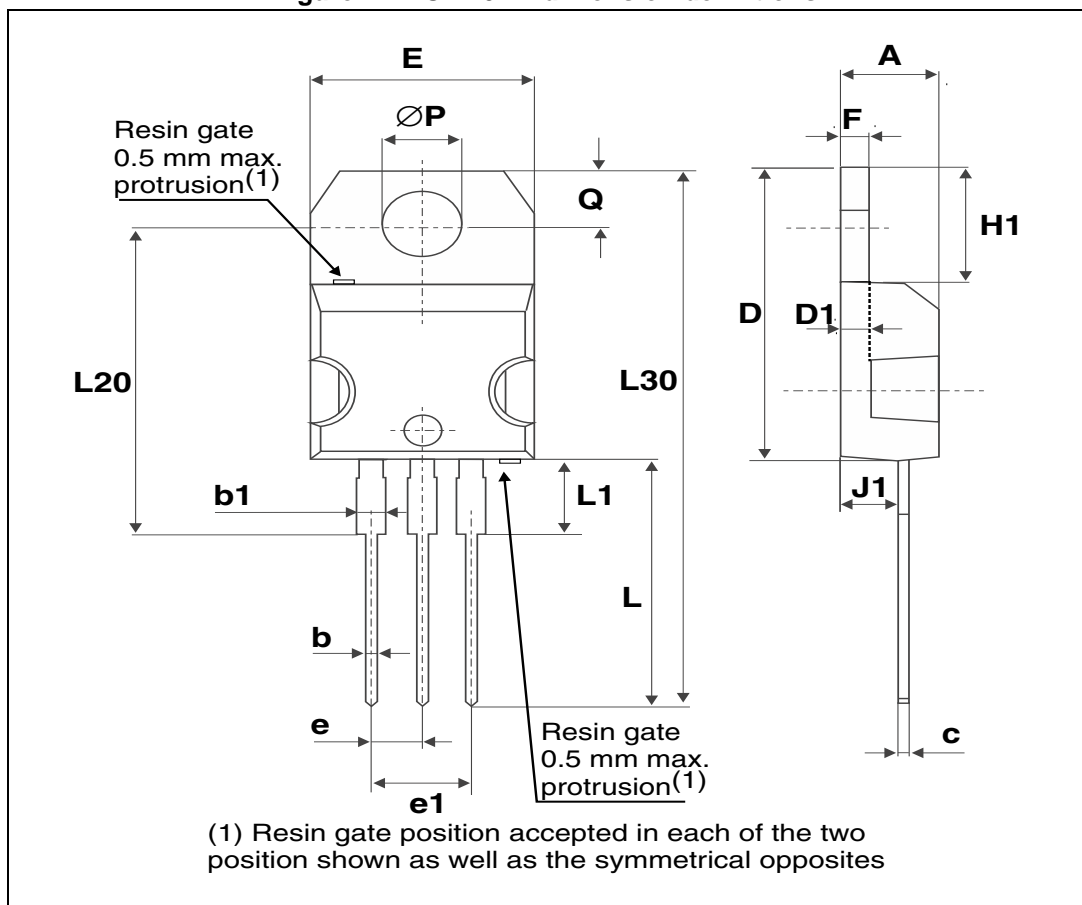

Table 6. TO-220AB dimension values

Ref.	Dimensions					
	Millimeters			Inches		
	Min.	Typ.	Max.	Min.	Typ.	Max.
A	15.20		15.90	0.598		0.625
a1		3.75			0.147	
a2	13.00		14.00	0.511		0.551
B	10.00		10.40	0.393		0.409
b1	0.61		0.88	0.024		0.034
b2	1.23		1.32	0.048		0.051
C	4.40		4.60	0.173		0.181
c1	0.49		0.70	0.019		0.027
c2	2.40		2.72	0.094		0.107
e	2.40		2.70	0.094		0.106
F	6.20		6.60	0.244		0.259
ØI	3.75		3.85	0.147		0.151
I4	15.80	16.40	16.80	0.622	0.646	0.661
L	2.65		2.95	0.104		0.116
I2	1.14		1.70	0.044		0.066
I3	1.14		1.70	0.044		0.066
M		2.60			0.102	

3 Ordering information

Figure 13. Ordering information scheme

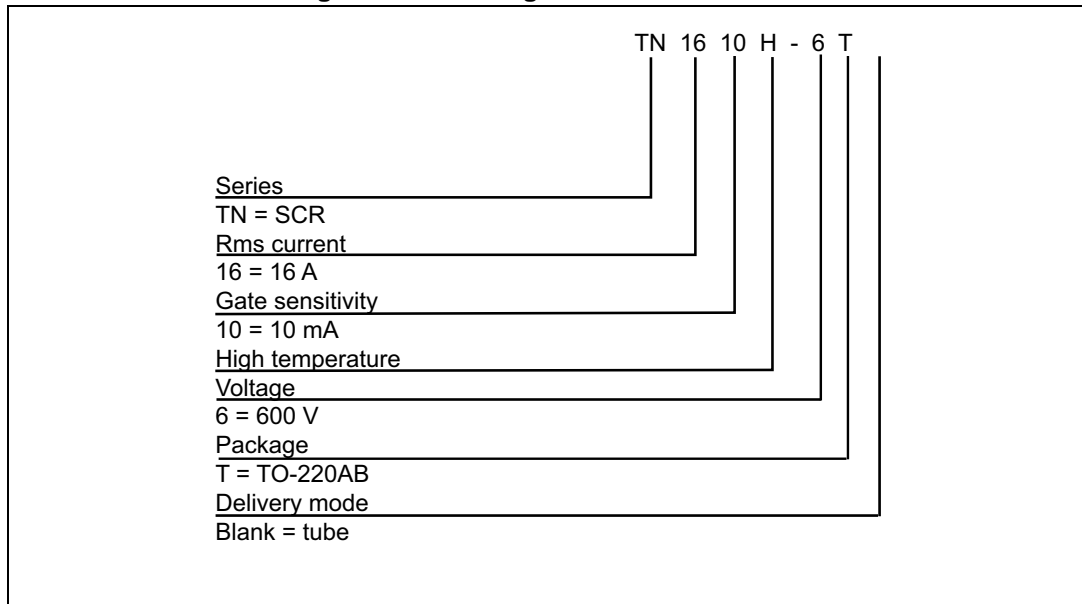

Table 7. Ordering information

Order code	Marking	Package	Weight	Base qty	Delivery mode
TN1610H-6T	TN1610H6	TO-220AB	2.3 g	50	Tube

4 Revision history

Table 8. Document revision history

Date	Revision	Changes
24-Feb-2015	1	Initial release.

IMPORTANT NOTICE – PLEASE READ CAREFULLY

STMicroelectronics NV and its subsidiaries ("ST") reserve the right to make changes, corrections, enhancements, modifications, and improvements to ST products and/or to this document at any time without notice. Purchasers should obtain the latest relevant information on ST products before placing orders. ST products are sold pursuant to ST's terms and conditions of sale in place at the time of order acknowledgement.

Purchasers are solely responsible for the choice, selection, and use of ST products and ST assumes no liability for application assistance or the design of Purchasers' products.

No license, express or implied, to any intellectual property right is granted by ST herein.

Resale of ST products with provisions different from the information set forth herein shall void any warranty granted by ST for such product.

ST and the ST logo are trademarks of ST. All other product or service names are the property of their respective owners.

Information in this document supersedes and replaces information previously supplied in any prior versions of this document.

© 2015 STMicroelectronics – All rights reserved