

$V_{DSS}$	-100V
$R_{DS(on)}$ (Max.)	120mΩ
$I_D$	-15A
$P_D$	50W

### ●Features

- 1) Low on-resistance.
- 2) Fast switching speed.
- 3) Drive circuits can be simple.
- 4) Parallel use is easy.
- 5) Pb-free lead plating ; RoHS compliant
- 6) 100% Avalanche tested

### ●Application

Switching Power Supply  
Automotive Motor Drive  
Automotive Solenoid Drive

### ●Absolute maximum ratings( $T_a = 25^\circ\text{C}$ )

Parameter	Symbol	Value	Unit
Drain - Source voltage	$V_{DSS}$	-100	V
Continuous drain current	$T_c = 25^\circ\text{C}$	$I_D^{*1}$	±15 A
	$T_c = 100^\circ\text{C}$	$I_D^{*1}$	±8 A
Pulsed drain current	$I_{D,pulse}^{*2}$	±30	A
Gate - Source voltage	$V_{GSS}$	±20	V
Avalanche energy, single pulse	$E_{AS}^{*3}$	33	mJ
Avalanche current	$I_{AR}^{*3}$	-15	A
Power dissipation	$T_c = 25^\circ\text{C}$	$P_D$	50 W
	$T_a = 25^\circ\text{C}^{*4}$	$P_D$	1.35 W
Junction temperature	$T_j$	150	°C
Range of storage temperature	$T_{stg}$	-55 to +150	°C

### ●Outline

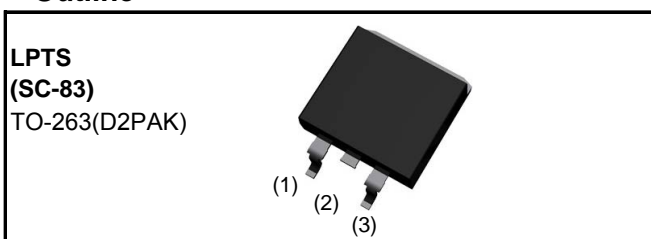

### ●Inner circuit

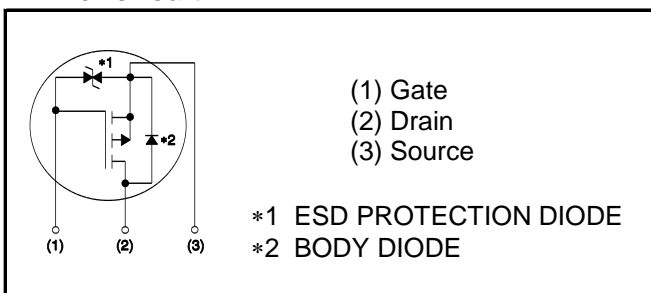

### ●Packaging specifications

Type	Packaging	Taping
	Reel size (mm)	330
	Tape width (mm)	16
	Basic ordering unit (pcs)	2,500
	Taping code	TL
	Marking	RSJ151P10

### ●Thermal resistance

Parameter	Symbol	Values			Unit
		Min.	Typ.	Max.	
Thermal resistance, junction - ambient	$R_{thJC}$	-	-	2.5	°C/W
Thermal resistance, junction - ambient *4	$R_{thJA}$	-	-	92.6	°C/W
Soldering temperature, wavesoldering for 10s	$T_{sold}$	-	-	265	°C

### ●Electrical characteristics( $T_a = 25^\circ\text{C}$ )

Parameter	Symbol	Conditions	Values			Unit
			Min.	Typ.	Max.	
Drain - Source breakdown voltage	$V_{(BR)DSS}$	$V_{GS} = 0V, I_D = -1mA$	-100	-	-	V
Zero gate voltage drain current	$I_{DSS}$	$V_{DS} = -100V, V_{GS} = 0V$ $T_j = 25^\circ\text{C}$	-	-	-1	$\mu\text{A}$
		$V_{DS} = -100V, V_{GS} = 0V$ $T_j = 125^\circ\text{C}$	-	-	-100	
Gate - Source leakage current	$I_{GSS}$	$V_{GS} = \pm 20V, V_{DS} = 0V$	-	-	$\pm 10$	$\mu\text{A}$
Gate threshold voltage	$V_{GS(th)}$	$V_{DS} = -10V, I_D = -1mA$	-1.0	-	-2.5	V
Static drain - source on - state resistance	$R_{DS(on)}$ *5	$V_{GS} = -10V, I_D = -15A$	-	85	120	$m\Omega$
		$V_{GS} = -4.5V, I_D = -15A$	-	95	135	
		$V_{GS} = -4.0V, I_D = -15A$	-	100	140	
		$V_{GS} = -10V, I_D = -15A$ $T_j = 125^\circ\text{C}$	-	155	220	
Forward transfer admittance	$g_{fs}$	$V_{DS} = -10V, I_D = -15A$	13	26	-	S

**●Electrical characteristics**( $T_a = 25^\circ\text{C}$ )

Parameter	Symbol	Conditions	Values			Unit
			Min.	Typ.	Max.	
Input capacitance	$C_{iss}$	$V_{GS} = 0\text{V}$	-	3800	-	pF
Output capacitance	$C_{oss}$	$V_{DS} = -25\text{V}$	-	160	-	
Reverse transfer capacitance	$C_{rss}$	$f = 1\text{MHz}$	-	100	-	
Turn - on delay time	$t_{d(on)}^{*5}$	$V_{DD} \approx -50\text{V}, V_{GS} = -10\text{V}$	-	30	-	ns
Rise time	$t_r^{*5}$	$I_D = -7.5\text{A}$	-	40	-	
Turn - off delay time	$t_{d(off)}^{*5}$	$R_L = 12\Omega$	-	165	-	
Fall time	$t_f^{*5}$	$R_G = 10\Omega$	-	95	-	

**●Gate Charge characteristics**( $T_a = 25^\circ\text{C}$ )

Parameter	Symbol	Conditions	Values			Unit
			Min.	Typ.	Max.	
Total gate charge	$Q_g^{*5}$	$V_{DD} \approx -50\text{V}$	-	64	-	nC
Gate - Source charge	$Q_{gs}^{*5}$	$I_D = -15\text{A}$	-	10	-	
Gate - Drain charge	$Q_{gd}^{*5}$	$V_{GS} = -10\text{V}$	-	10	-	
Gate plateau voltage	$V_{(plateau)}$	$V_{DD} \approx -50\text{V}, I_D = -15\text{A}$	-	-3.1	-	V

**●Body diode electrical characteristics (Source-Drain)**( $T_a = 25^\circ\text{C}$ )

Parameter	Symbol	Conditions	Values			Unit
			Min.	Typ.	Max.	
Continuous source current	$I_S^{*1}$	$T_c = 25^\circ\text{C}$	-	-	-15	A
Pulsed source current	$I_{SM}^{*2}$		-	-	-30	A
Forward voltage	$V_{SD}^{*5}$	$V_{GS} = 0\text{V}, I_S = -15\text{A}$	-	-	-1.2	V
Reverse recovery time	$t_{rr}^{*5}$	$I_S = -15\text{A}$	-	60	-	ns
Reverse recovery charge	$Q_{rr}^{*5}$	$di/dt = -100\text{A}/\mu\text{s}$	-	145	-	$\mu\text{C}$

\*1 Limited only by maximum temperature allowed.

\*2  $P_w \leq 10\mu\text{s}$ , Duty cycle  $\leq 1\%$

\*3  $L \approx 200\mu\text{H}$ ,  $V_{DD} = -50\text{V}$ ,  $R_G = 10\Omega$ , starting  $T_j = 25^\circ\text{C}$

\*4 Mounted on a epoxy PCB FR4 (20mm x 30mm x 0.8mm)

\*5 Pulsed

●Electrical characteristic curves

Fig.1 Power Dissipation Derating Curve

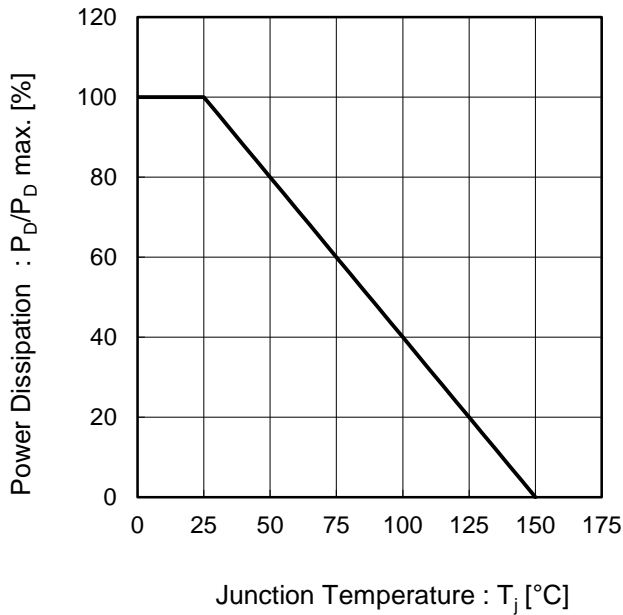

Fig.2 Maximum Safe Operating Area

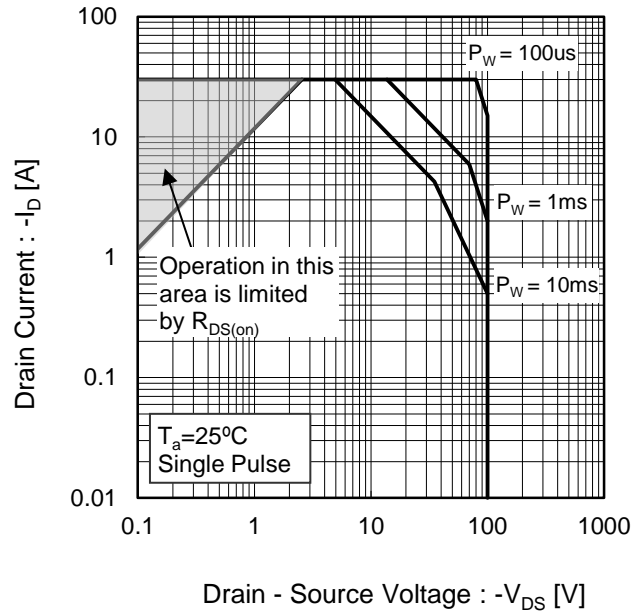
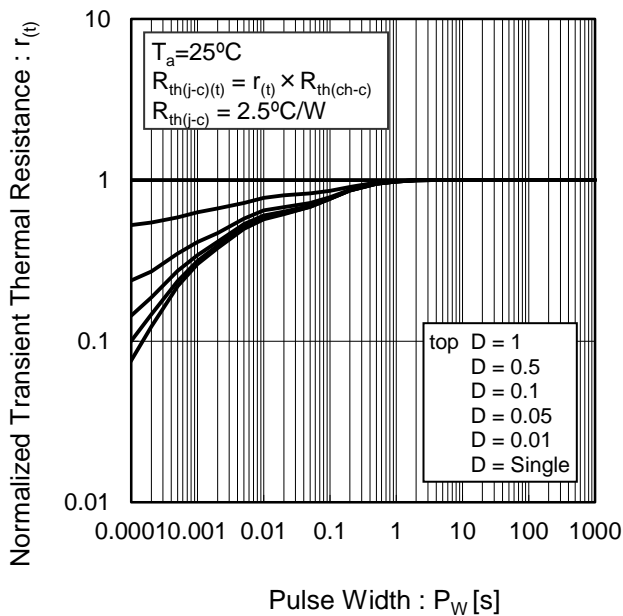

Fig.3 Normalized Transient Thermal Resistance vs. Pulse Width



●Electrical characteristic curves

Fig.4 Avalanche Current vs Inductive Load

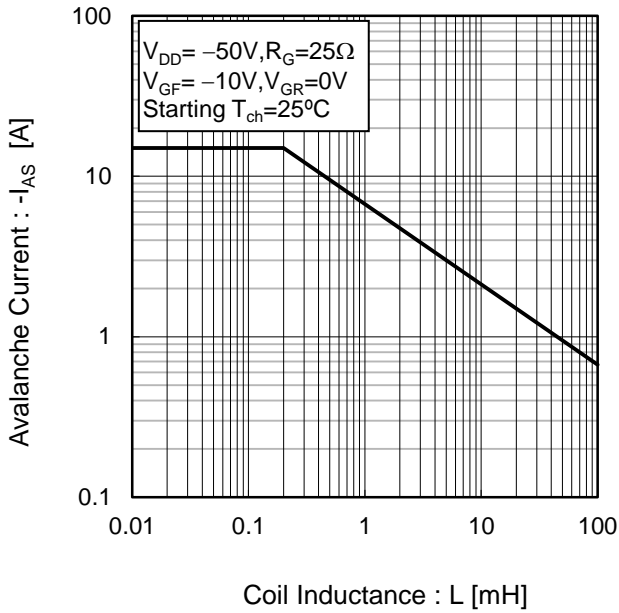

Fig.5 Avalanche Energy Derating Curve vs Junction Temperature

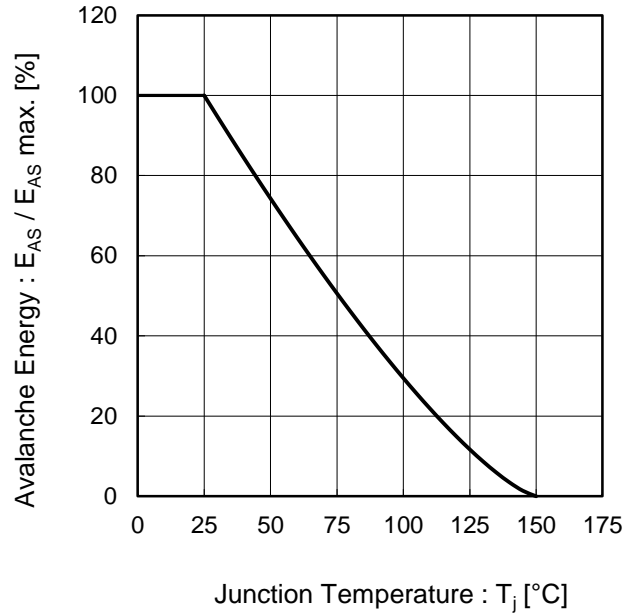

Fig.6 Typical Output Characteristics(I)

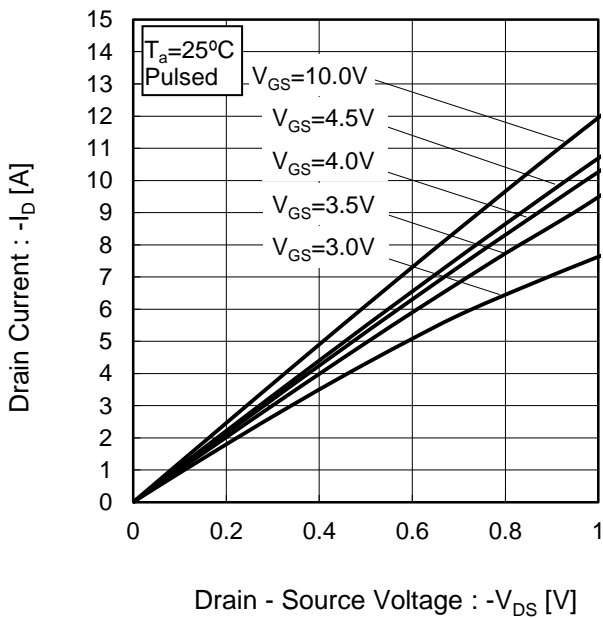
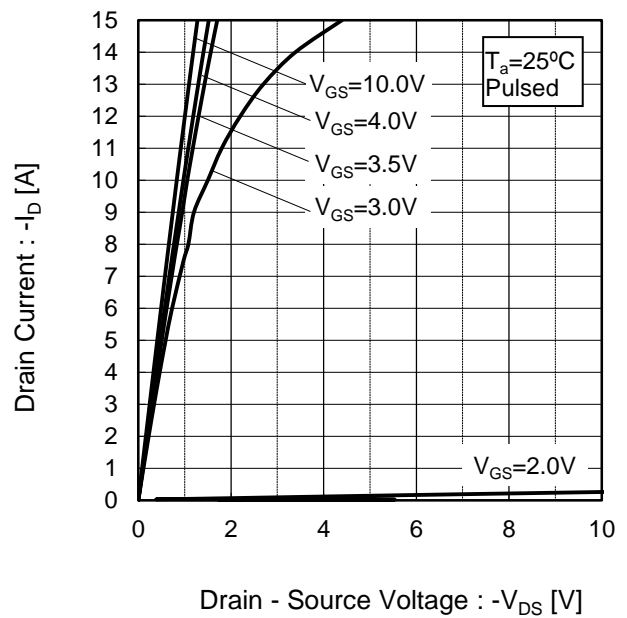

Fig.7 Typical Output Characteristics(II)



●Electrical characteristic curves

Fig.8 Breakdown Voltage vs. Junction Temperature

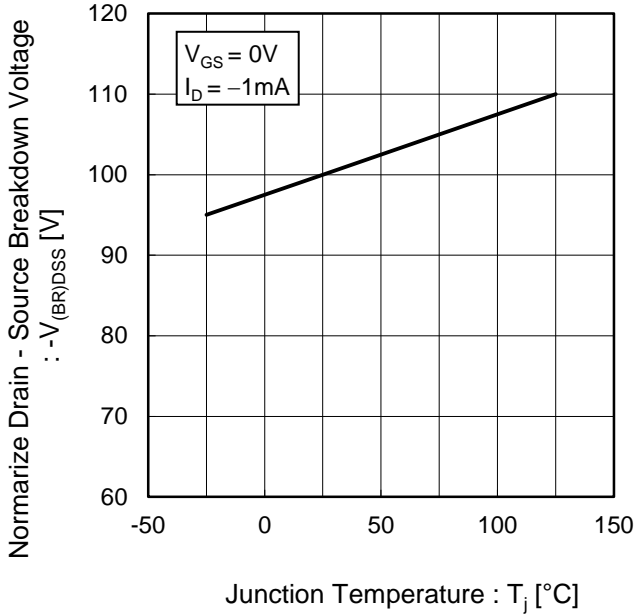

Fig.9 Typical Transfer Characteristics

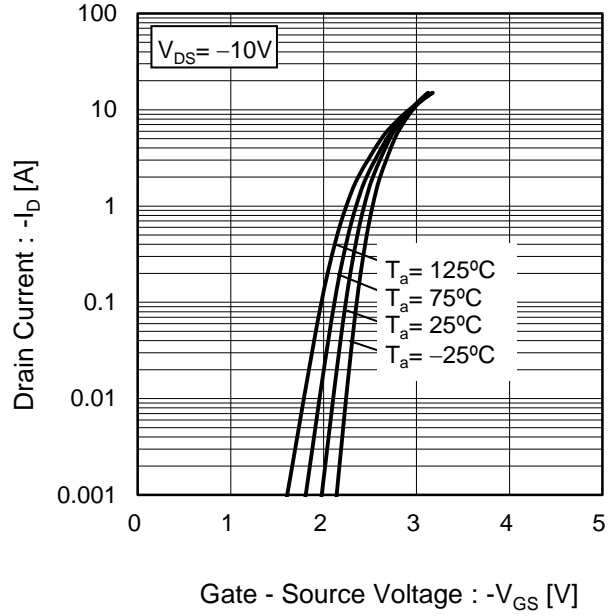

Fig.10 Gate Threshold Voltage vs. Junction Temperature

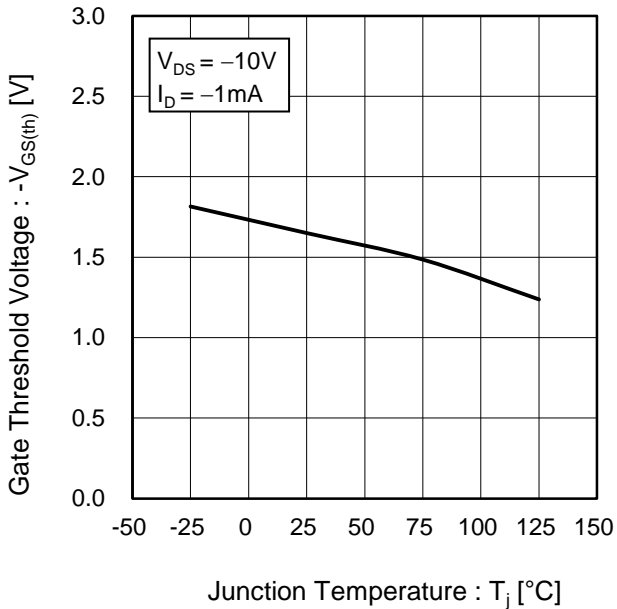
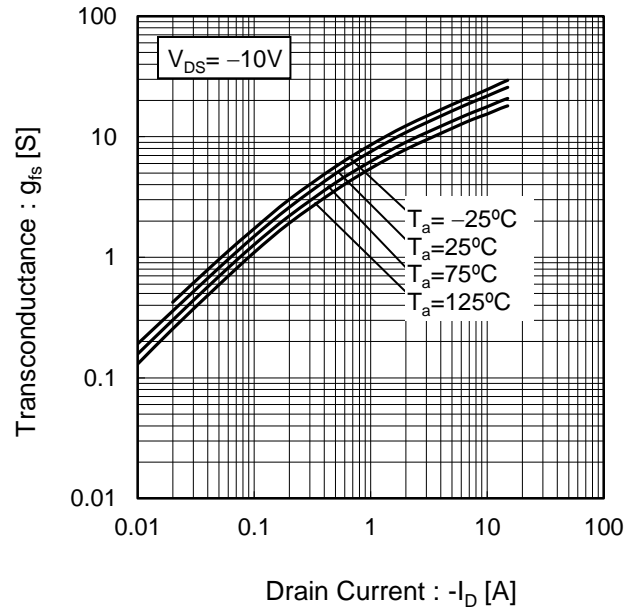

Fig.11 Transconductance vs. Drain Current



●Electrical characteristic curves

Fig.12 Static Drain - Source On - State Resistance vs. Gate Source Voltage

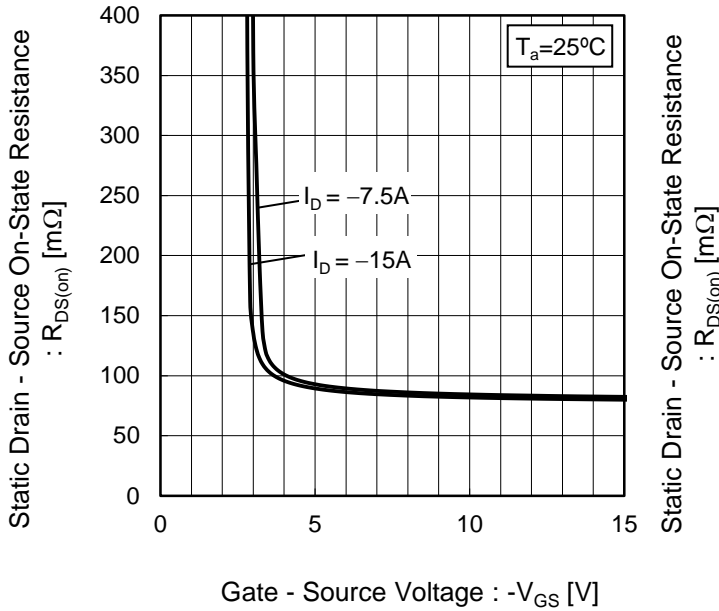

Fig.13 Static Drain - Source On - State Resistance vs. Drain Current(I)

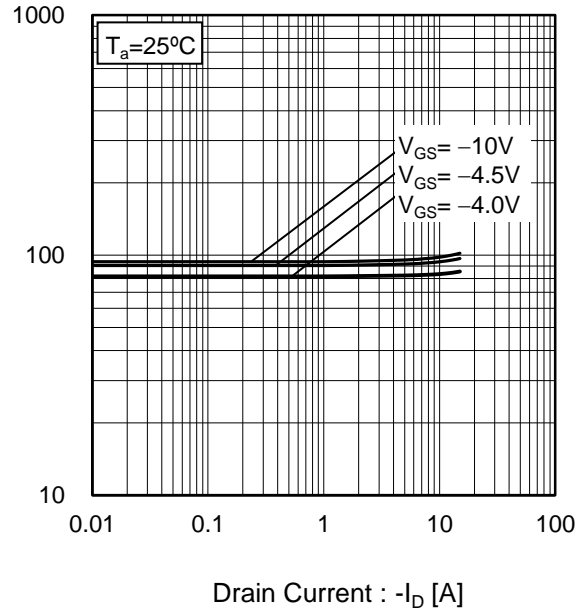
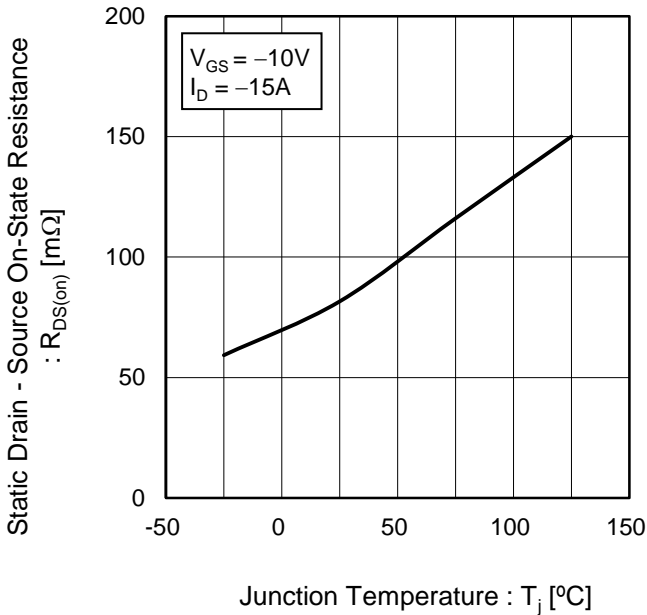

Fig.14 Static Drain - Source On - State Resistance vs. Junction Temperature



●Electrical characteristic curves

Fig.15 Static Drain - Source On - State Resistance vs. Drain Current(II)

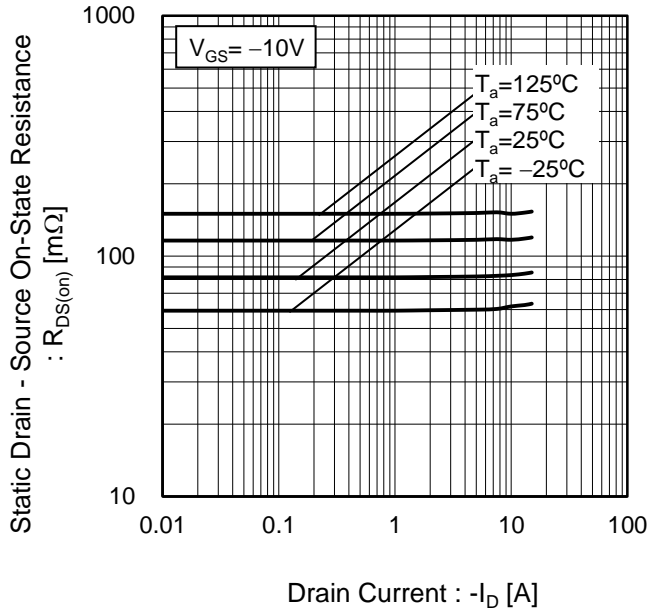

Fig.16 Static Drain - Source On - State Resistance vs. Drain Current(III)

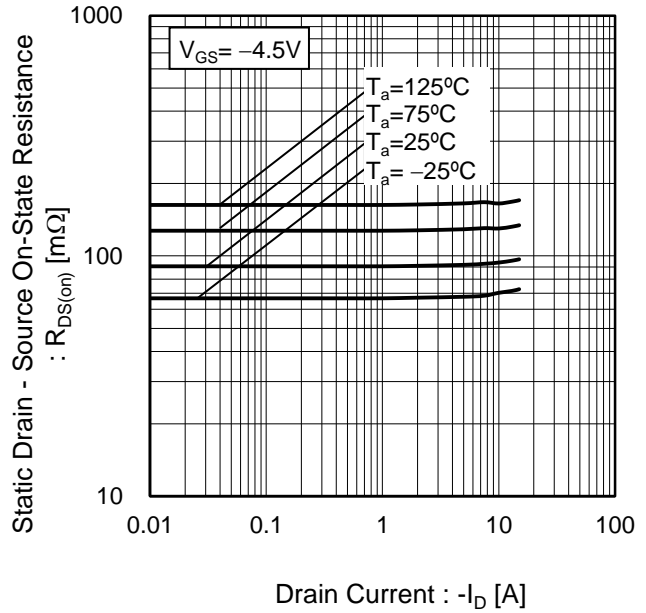

Fig.17 Static Drain - Source On - State Resistance vs. Drain Current(IV)

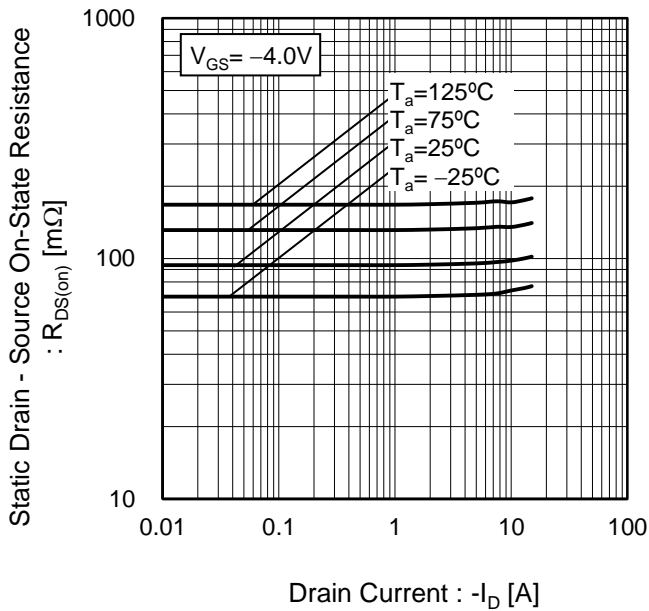
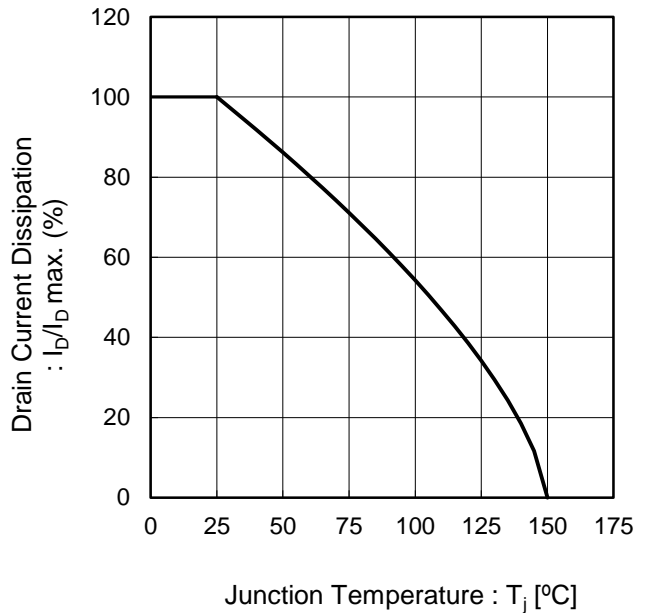

Fig.18 Drain Current Derating Curve





●Electrical characteristic curves

Fig.19 Typical Capacitance vs. Drain - Source Voltage

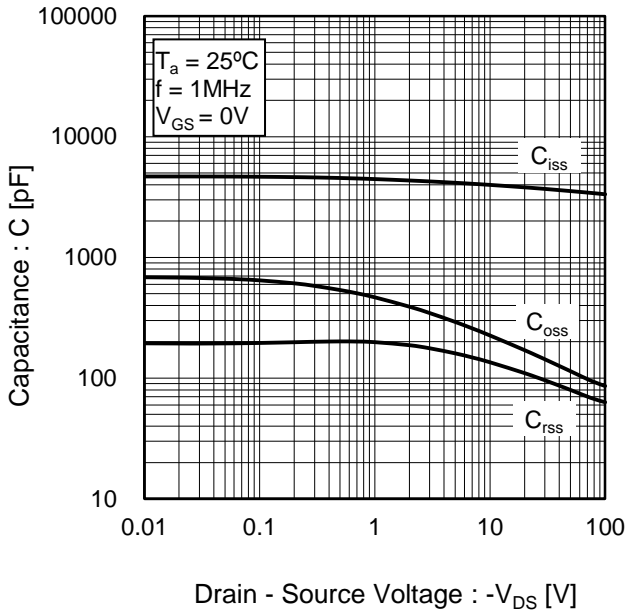

Fig.20 Switching Characteristics

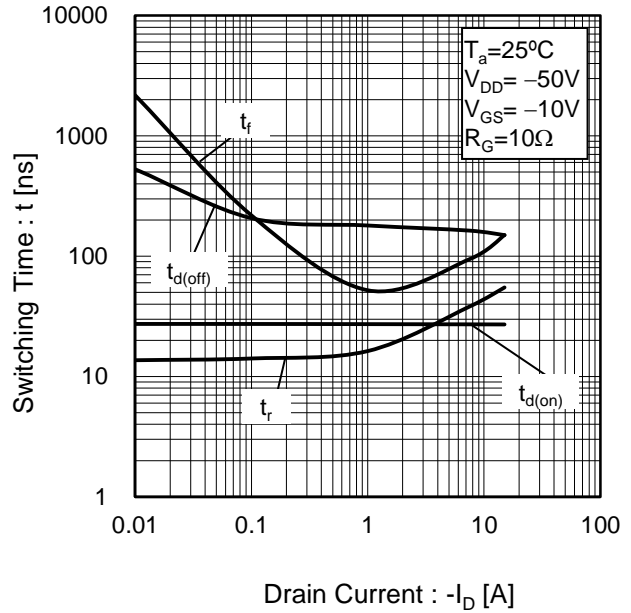

Fig.21 Dynamic Input Characteristics

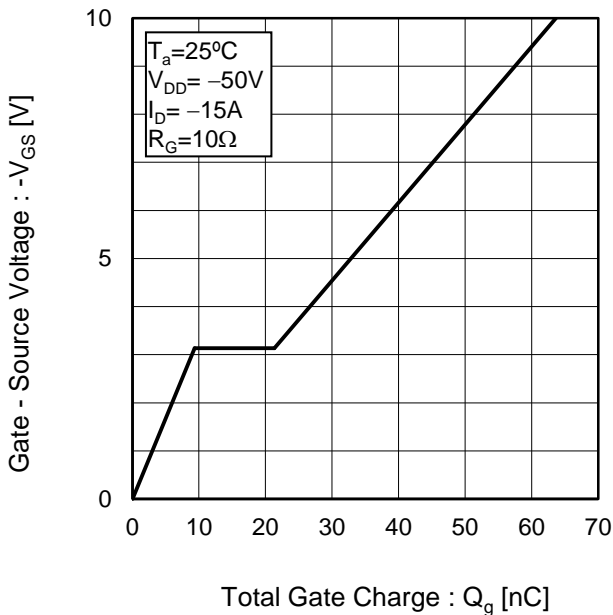
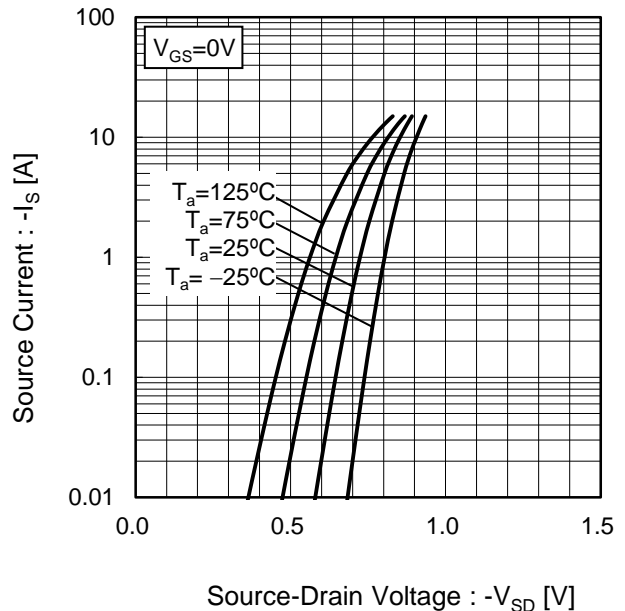
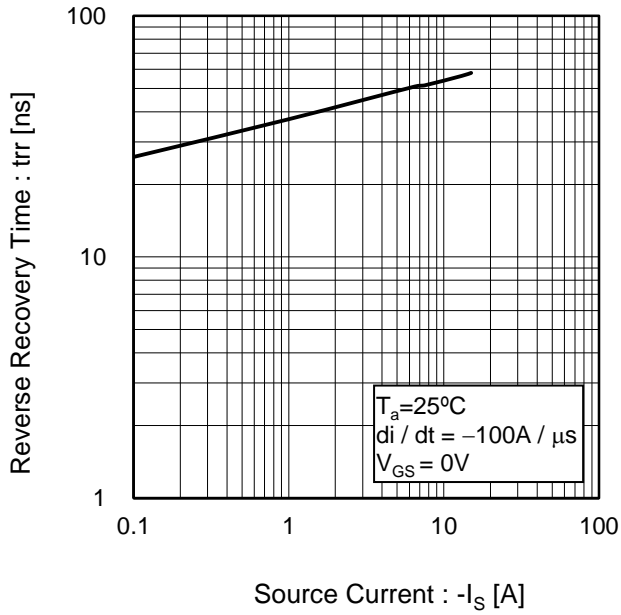

Fig.22 Source Current vs. Source - Drain Voltage



●Electrical characteristic curves

Fig23 Reverse Recovery Time vs.Source Current



●Measurement circuits

Fig.1-1 Switching Time Measurement Circuit

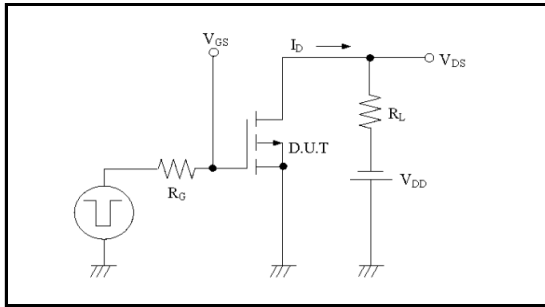

Fig.1-2 Switching Waveforms

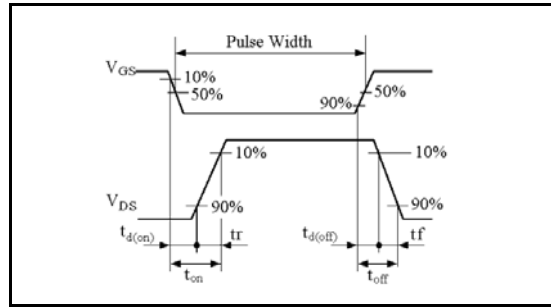

Fig.2-1 Gate Charge Measurement Circuit

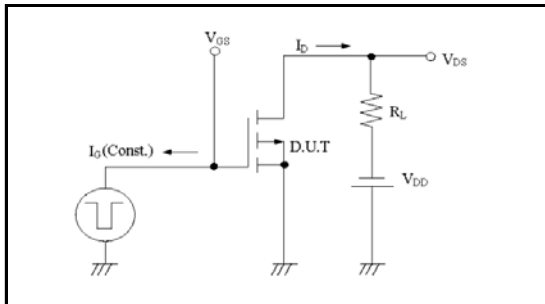

Fig.2-2 Gate Charge Waveform

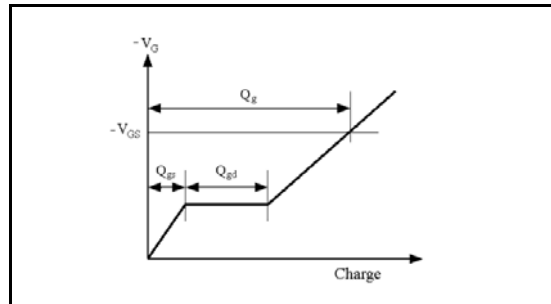
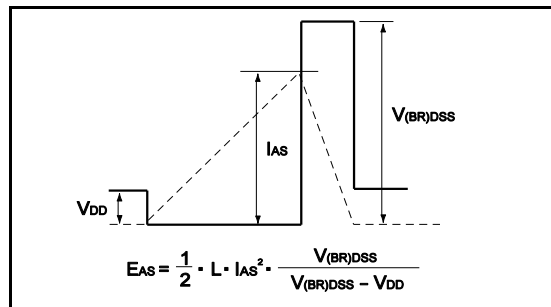

Fig.3-1 Avalanche Measurement Circuit



Fig.3-2 Avalanche Waveform



●Dimensions (Unit : mm)

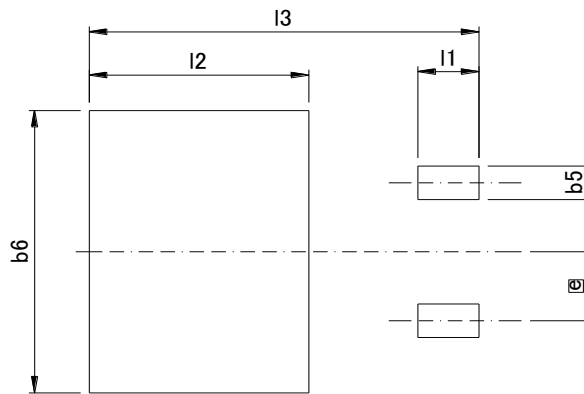
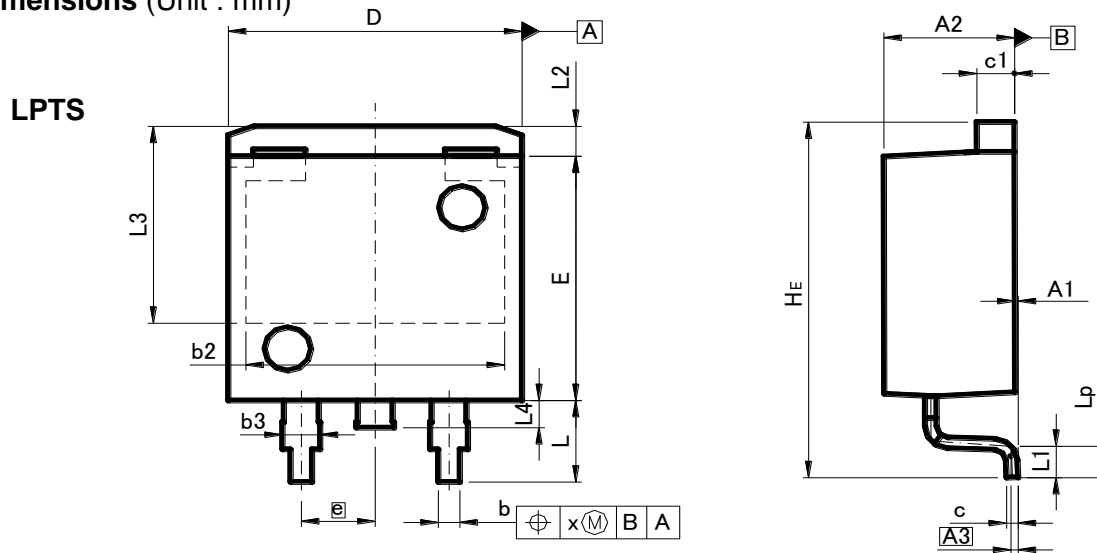

Pattern of terminal position areas  
[Not a recommended pattern of soldering pads]

DIM	MILIMETERS		INCHES	
	MIN	MAX	MIN	MAX
A1	0.00	0.30	0.000	0.012
A2	4.30	4.70	0.169	0.185
A3	0.25		0.010	
b	0.68	0.98	0.027	0.039
b2	8.90		0.350	
b3	1.14	1.44	0.045	0.057
c	0.30	0.60	0.012	0.024
c1	1.10	1.50	0.043	0.059
D	9.80	10.40	0.386	0.409
E	8.80	9.20	0.346	0.362
e	2.54		0.100	
HE	12.80	13.40	0.504	0.528
L	2.70	3.30	0.106	0.130
L1	0.90	1.50	0.035	0.059
L2	1.10		0.043	
L3	7.25		0.285	
L4	1.00		0.039	
Lp	0.90	1.50	0.035	0.059
x	-	0.25	-	0.010

DIM	MILIMETERS		INCHES	
	MIN	MAX	MIN	MAX
b5	-	1.23	-	0.049
b6	-	10.40	-	0.409
I1	-	2.10	-	0.083
I2	-	7.55	-	0.297
I3	-	13.40	-	0.528

Dimension in mm / inches

## Notes

- 1) The information contained herein is subject to change without notice.
- 2) Before you use our Products, please contact our sales representative and verify the latest specifications :
- 3) Although ROHM is continuously working to improve product reliability and quality, semiconductors can break down and malfunction due to various factors.  
Therefore, in order to prevent personal injury or fire arising from failure, please take safety measures such as complying with the derating characteristics, implementing redundant and fire prevention designs, and utilizing backups and fail-safe procedures. ROHM shall have no responsibility for any damages arising out of the use of our Products beyond the rating specified by ROHM.
- 4) Examples of application circuits, circuit constants and any other information contained herein are provided only to illustrate the standard usage and operations of the Products. The peripheral conditions must be taken into account when designing circuits for mass production.
- 5) The technical information specified herein is intended only to show the typical functions of and examples of application circuits for the Products. ROHM does not grant you, explicitly or implicitly, any license to use or exercise intellectual property or other rights held by ROHM or any other parties. ROHM shall have no responsibility whatsoever for any dispute arising out of the use of such technical information.
- 6) The Products are intended for use in general electronic equipment (i.e. AV/OA devices, communication, consumer systems, gaming/entertainment sets) as well as the applications indicated in this document.
- 7) The Products specified in this document are not designed to be radiation tolerant.
- 8) For use of our Products in applications requiring a high degree of reliability (as exemplified below), please contact and consult with a ROHM representative : transportation equipment (i.e. cars, ships, trains), primary communication equipment, traffic lights, fire/crime prevention, safety equipment, medical systems, servers, solar cells, and power transmission systems.
- 9) Do not use our Products in applications requiring extremely high reliability, such as aerospace equipment, nuclear power control systems, and submarine repeaters.
- 10) ROHM shall have no responsibility for any damages or injury arising from non-compliance with the recommended usage conditions and specifications contained herein.
- 11) ROHM has used reasonable care to ensure the accuracy of the information contained in this document. However, ROHM does not warrant that such information is error-free, and ROHM shall have no responsibility for any damages arising from any inaccuracy or misprint of such information.
- 12) Please use the Products in accordance with any applicable environmental laws and regulations, such as the RoHS Directive. For more details, including RoHS compatibility, please contact a ROHM sales office. ROHM shall have no responsibility for any damages or losses resulting from non-compliance with any applicable laws or regulations.
- 13) When providing our Products and technologies contained in this document to other countries, you must abide by the procedures and provisions stipulated in all applicable export laws and regulations, including without limitation the US Export Administration Regulations and the Foreign Exchange and Foreign Trade Act.
- 14) This document, in part or in whole, may not be reprinted or reproduced without prior consent of ROHM.



Thank you for your accessing to ROHM product informations.  
More detail product informations and catalogs are available, please contact us.

## ROHM Customer Support System

<http://www.rohm.com/contact/>