



ON Semiconductor®

<http://onsemi.com>

# PCP1403

## N-Channel Power MOSFET 60V, 4.5A, 117mΩ, Single PCP

### Features

- On-resistance  $R_{DS(on)1}=92m\Omega$ (typ.)
- 4V drive
- Protection Diode in
- Halogen free compliance

### Specifications

#### Absolute Maximum Ratings at $T_a = 25^\circ\text{C}$

Parameter	Symbol	Conditions	Value	Unit
Drain to Source Voltage	$V_{DSS}$		60	V
Gate to Source Voltage	$V_{GSS}$		$\pm 20$	V
Drain Current (DC)	$I_D$		4.5	A
Drain Current (Pulse)	$I_{DP}$	$PW \leq 10\mu s$ , duty cycles $\leq 1\%$	18	A
Power Dissipation	$P_D$	$T_c = 25^\circ\text{C}$	3.5	W
		When mounted on ceramic substrate (600mm <sup>2</sup> × 0.8mm)	1.3	W
Junction Temperature	$T_j$		150	$^\circ\text{C}$
Storage Temperature	$T_{stg}$		- 55 to +150	$^\circ\text{C}$

Stresses exceeding those listed in the Maximum Ratings table may damage the device. If any of these limits are exceeded, device functionality should not be assumed, damage may occur and reliability may be affected.

### Thermal Resistance Ratings

Parameter	Symbol	Value	Unit
Junction to Case Steady State	$R_{\theta JC}$	35.7	$^\circ\text{C}/\text{W}$
Junction to Ambient When mounted on ceramic substrate (600mm <sup>2</sup> × 0.8mm)	$R_{\theta JA}$	96.1	$^\circ\text{C}/\text{W}$

### Electrical Characteristics at $T_a = 25^\circ\text{C}$

Parameter	Symbol	Conditions	Value			Unit
			min	typ	max	
Drain to Source Breakdown Voltage	$V_{(BR)DSS}$	$I_D = 1\text{mA}$ , $V_{GS} = 0\text{V}$	60			V
Zero-Gate Voltage Drain Current	$I_{DSS}$	$V_{DS} = 60\text{V}$ , $V_{GS} = 0\text{V}$			1	$\mu\text{A}$
Gate to Source Leakage Current	$I_{GSS}$	$V_{GS} = \pm 16\text{V}$ , $V_{DS} = 0\text{V}$			$\pm 10$	$\mu\text{A}$
Gate Threshold Voltage	$V_{GS(th)}$	$V_{DS} = 10\text{V}$ , $I_D = 1\text{mA}$	1.2		2.6	V
Forward Transconductance	$g_{FS}$	$V_{DS} = 10\text{V}$ , $I_D = 2\text{A}$		2.5		S
Static Drain to Source On-State Resistance	$R_{DS(on)1}$	$I_D = 2\text{A}$ , $V_{GS} = 10\text{V}$		92	117	$m\Omega$
	$R_{DS(on)2}$	$I_D = 1\text{A}$ , $V_{GS} = 4.5\text{V}$		120	168	$m\Omega$
	$R_{DS(on)3}$	$I_D = 1\text{A}$ , $V_{GS} = 4\text{V}$		132	185	$m\Omega$
Input Capacitance	$C_{iss}$	$V_{DS} = 20\text{V}$ , $f = 1\text{MHz}$		310		pF
Output Capacitance	$C_{oss}$			40		pF
Reverse Transfer Capacitance	$C_{rss}$			25		pF

Continued on next page.

### ORDERING INFORMATION

See detailed ordering and shipping information on page 2 of this data sheet.

# PCP1403

Continued from preceding page.

Parameter	Symbol	Conditions	Value			Unit
			min	typ	max	
Turn-ON Delay Time	$t_{d(on)}$	See specified Test Circuit		5.6		ns
Rise Time	$t_r$			7.0		ns
Turn-OFF Delay Time	$t_{d(off)}$			26		ns
Fall Time	$t_f$			14		ns
Total Gate Charge	$Q_g$	$V_{DS}=30V, V_{GS}=10V, I_D=4.5A$		6.7		nC
Gate to Source Charge	$Q_{gs}$			1.0		nC
Gate to Drain "Miller" Charge	$Q_{gd}$			1.6		nC
Forward Diode Voltage	$V_{SD}$	$I_S=4.5A, V_{GS}=0V$		0.88	1.2	V

Product parametric performance is indicated in the Electrical Characteristics for the listed test conditions, unless otherwise noted. Product performance may not be indicated by the Electrical Characteristics if operated under different conditions.

## Ordering & Package Information

Device	Package	Shipping	note
PCP1403-TD-H	PCP, SC-62 SOT-89, TO-243	1,000 pcs. / reel	Pb-Free and Halogen Free

## Packing Type:TD

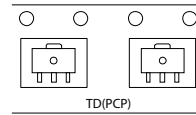

## Marking

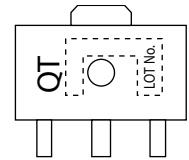

## Electrical Connection

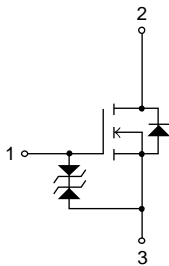

## Switching Time Test Circuit

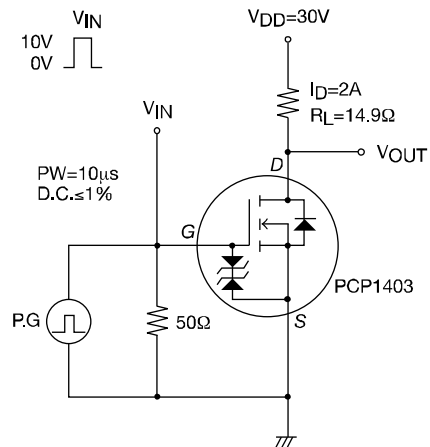

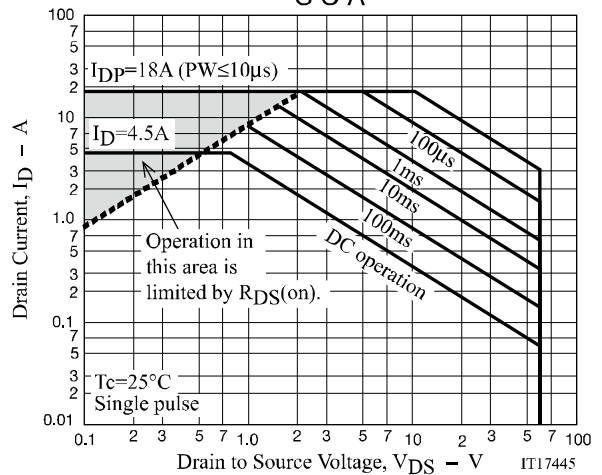
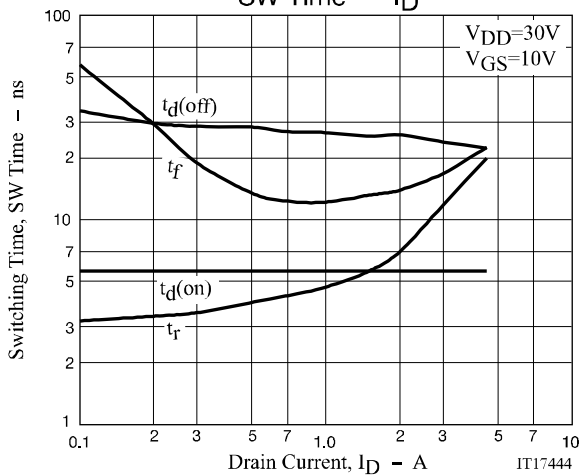
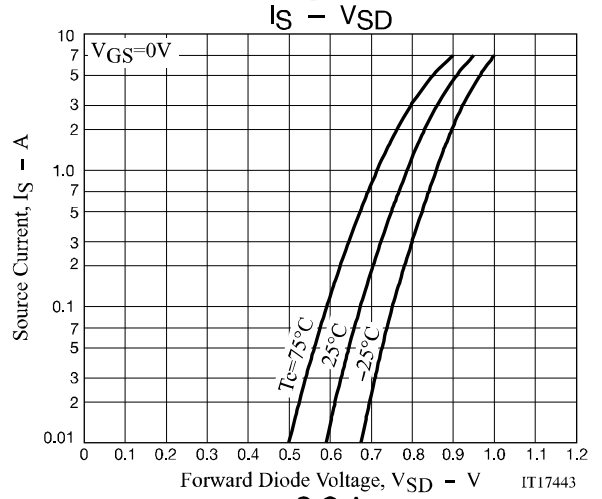
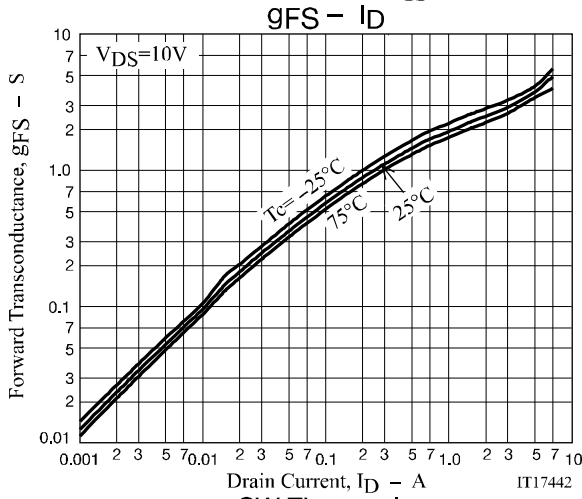
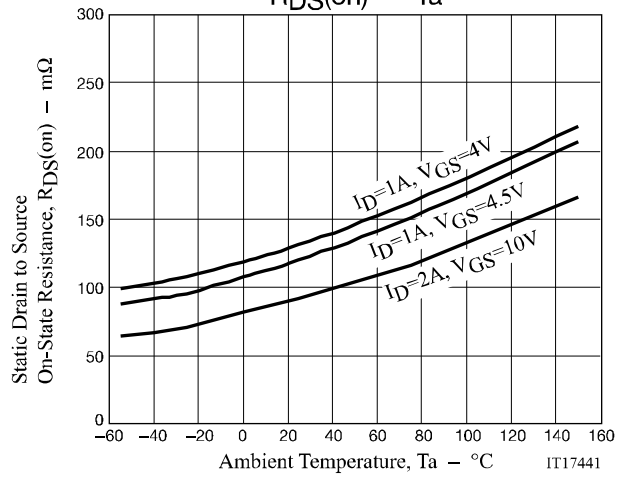
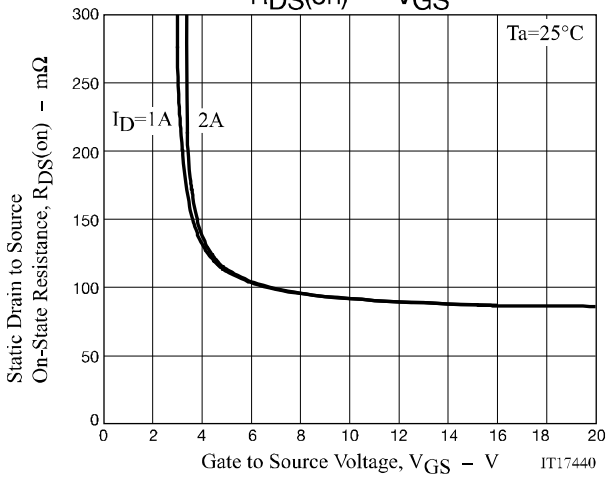
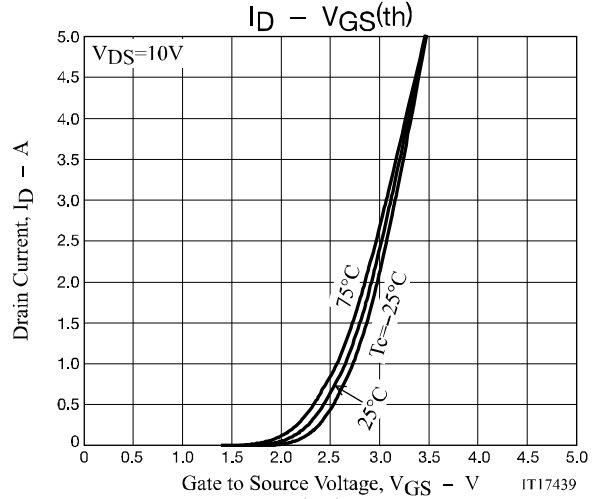
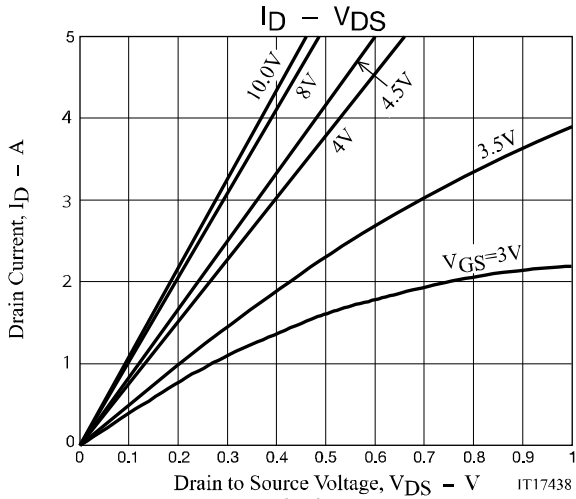

# PCP1403

