



12TQ200/12TQ200S SCHOTTKY RECTIFIER



Applications:

- Switching power supply
- Redundant power subsystems
- Converters
- Free-Wheeling diodes
- Reverse battery protection

Features:

- 175°C T_J operation
- High purity, high temperature epoxy encapsulation for enhanced mechanical strength and moisture resistance
- Low forward voltage drop
- High frequency operation
- Guard ring for enhanced ruggedness and long term reliability
- This is a Pb – Free Device
- All SMC parts are traceable to the wafer lot
- Additional testing can be offered upon request

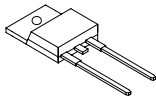
Mechanical Dimensions: In mm / Inches

Case styles	
<p>12TQ...</p>  <p>TO-220AC</p>	<p>12TQ...S</p>  <p>D²PAK</p>

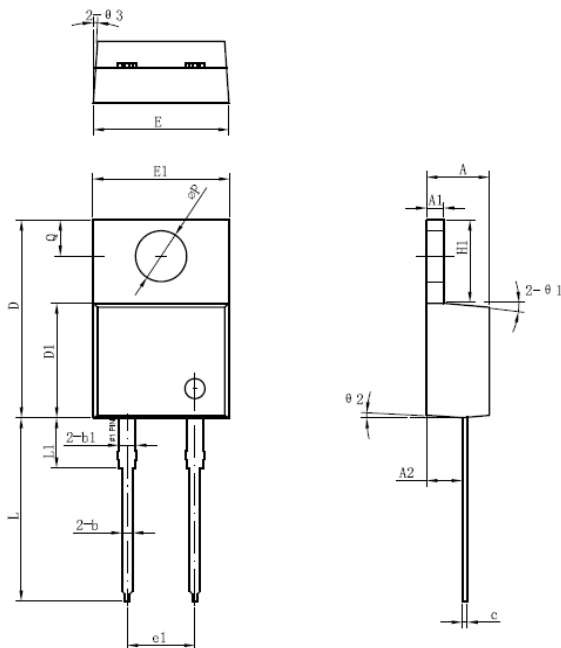

Symbol	Dimensions in millimeters		
	Min.	Typical	Max.
A	4.55	4.70	4.85
A1	1.17	1.27	1.37
A2	2.59	2.69	2.89
b	0.71	0.81	0.96
b1		1.27	
c	0.36	0.38	0.61
D	14.64	14.94	15.24
D1	8.55	8.07	8.85
E	10.01	10.16	10.31
E1	9.98	10.18	10.38
e1		5.08	
H1	6.04	6.24	6.44
L	13.00	13.86	14.08
L1		3.80	
ΦP	3.74	3.84	4.04
Q	2.54	2.74	2.94
Ø1		5°	
Ø2		4°	
Ø3		4°	

TO-220AC

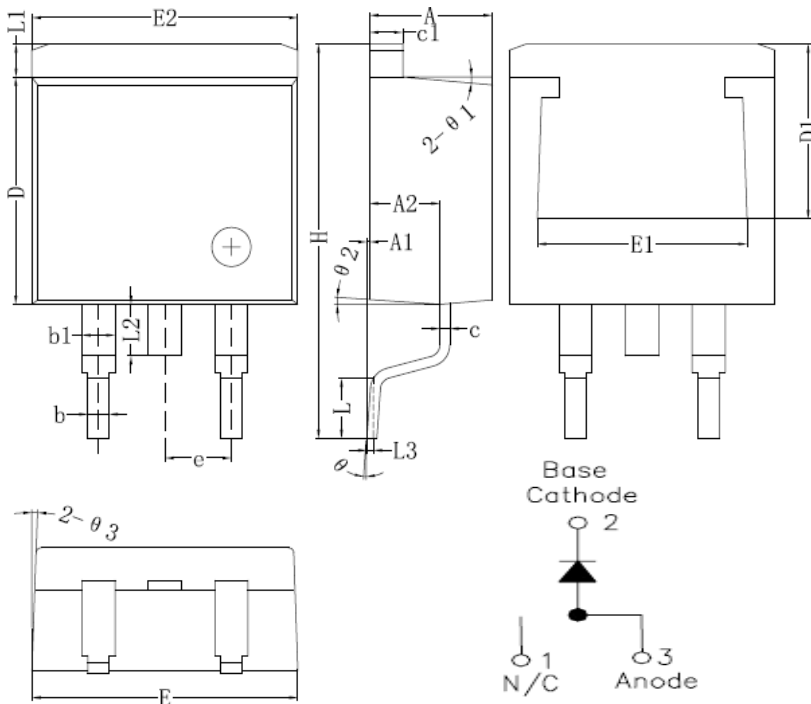

Symbol	Dimensions in millimeters		
	Min.	Typical	Max.
A	4.55	4.70	4.85
A1	0	0.10	0.25
A2	2.59	2.69	2.89
b	0.71	0.81	0.96
b1		1.27	
c	0.36	0.38	0.61
c1	1.17	1.27	1.37
D	8.55	8.70	8.85
D1	6.40		
E	10.01	10.16	10.31
E1	7.6		
E2	9.98	10.08	10.18
e		2.54	
H	14.6	15.1	15.6
L	2.00	2.30	2.70
L1	1.17	1.27	1.40
L2			2.20
L3		0.25BSC	
e	0	-	8°
e1		5°	
e2		4°	
e3		4°	

D²PAK

Technical Data
Data Sheet N0664, Rev. -
Marking Diagram:

Green Products

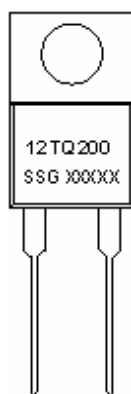

12TQ200

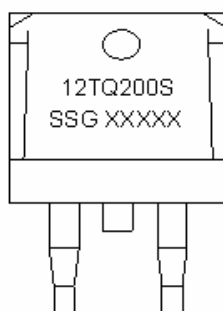

12TQ200S

Where XXXXX is YYWWL

12TQ200 =Part Name
SSG = SSG
YY = Year
WW = Week
L = Lot Number

Cautions: Molding resin
Epoxy resin UL:94V-0

Ordering Information:

Device	Package	Shipping
12TQ...	TO-220AC (Pb-Free)	50pcs / tube
12TQ...S	D ² PAK (Pb-Free)	800pcs / reel

For information on tape and reel specifications, including part orientation and tape sizes, please refer to our Tape and Reel Packaging Specification.

Maximum Ratings:

Characteristics	Symbol	Condition	Max.	Units
Peak Inverse Voltage	V_{RWM}	-	200	V
Max. Average Forward	$I_{F(AV)}$	50% duty cycle @ $T_C=136^{\circ}C$, rectangular wave form	15	A
Max. Peak One Cycle Non- Repetitive Surge Current (per leg)	I_{FSM}	8.3 ms, half Sine pulse	276	A

Electrical Characteristics:

Characteristics	Symbol	Condition	Max.	Units
Max. Forward Voltage Drop *	V _{F1}	@ 15A, Pulse, T _J = 25 °C	0.92	V
	V _{F2}	@ 15A, Pulse, T _J = 125 °C	0.76	V
Max. Reverse Current at DC condition	I _{R1}	@V _R = rated V _R T _J = 25 °C	0.55	mA
Max. Reverse Current	I _{R2}	@V _R = rated V _R T _J = 125 °C	7	mA
Max. Junction Capacitance	C _T	@V _R = 5V, T _C = 25 °C f _{SIG} = 1MHz	300	pF
Typical Series Inductance	L _S	Measured lead to lead 5 mm from package body	8.0	nH
Max. Voltage Rate of Change(Rated V _R)	dv/dt	-	10,000	V/μs

* Pulse Width < 300μs, Duty Cycle <2%

Thermal-Mechanical Specifications:

Characteristics	Symbol	Condition	Specification	Units
Max. Junction Temperature	T _J	-	-55 to +175	°C
Max. Storage Temperature	T _{stg}	-	-55 to +175	°C
Maximum Thermal Resistance Junction to Case (per leg)	R _{θJC}	DC operation	2.0	°C/W
Typical Thermal Resistance, case to Heat Sink	R _{θCS}	Mounting surface, smooth and greased	0.50	°C/W
Approximate Weight	wt	-	2	g
Case Style	TO-220AC, D ² PAK(Suffix "s" for D ² PAK; "MBRB" for D ² PAK)			



Typical Forward Characteristics

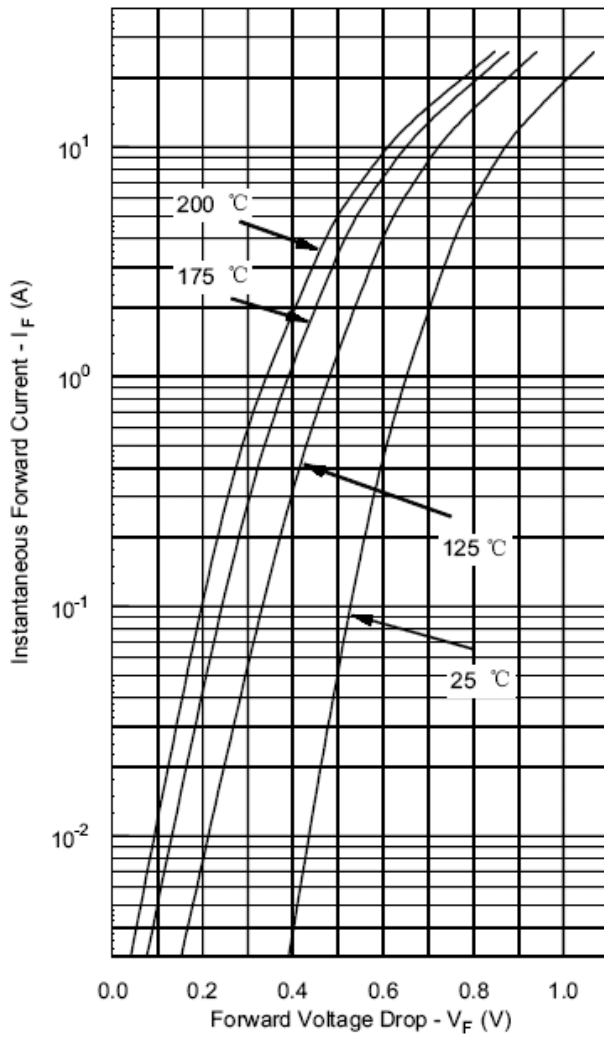

Typical Reverse Characteristics

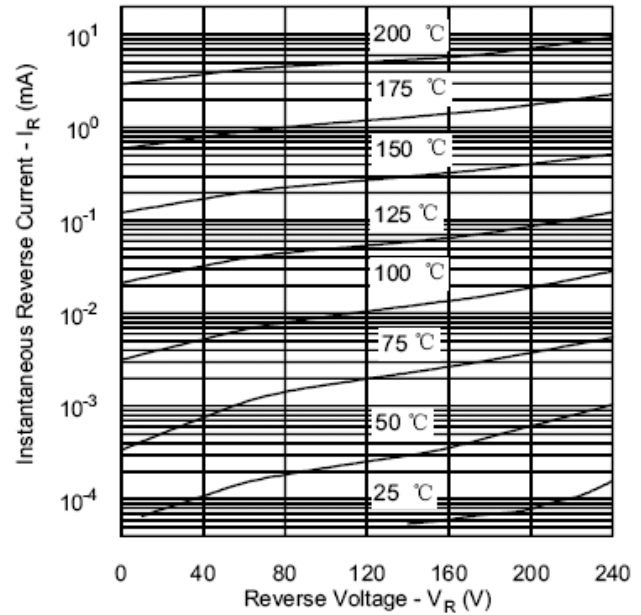

Typical Junction Capacitance

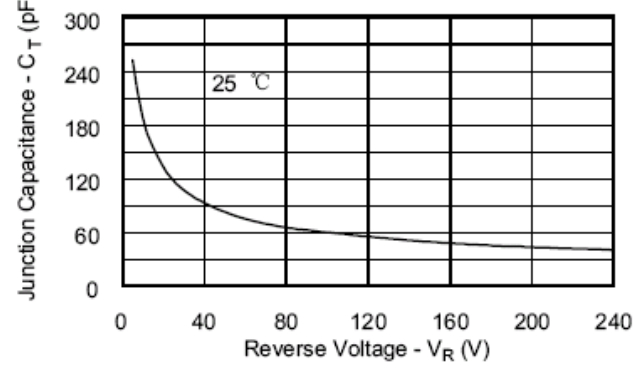



DISCLAIMER:

- 1- The information given herein, including the specifications and dimensions, is subject to change without prior notice to improve product characteristics. Before ordering, purchasers are advised to contact the SMC - Sangdest Microelectronics (Nanjing) Co., Ltd sales department for the latest version of the datasheet(s).
- 2- In cases where extremely high reliability is required (such as use in nuclear power control, aerospace and aviation, traffic equipment, medical equipment , and safety equipment) , safety should be ensured by using semiconductor devices that feature assured safety or by means of users' fail-safe precautions or other arrangement .
- 3- In no event shall SMC - Sangdest Microelectronics (Nanjing) Co., Ltd be liable for any damages that may result from an accident or any other cause during operation of the user's units according to the datasheet(s). SMC - Sangdest Microelectronics (Nanjing) Co., Ltd assumes no responsibility for any intellectual property claims or any other problems that may result from applications of information, products or circuits described in the datasheets.
- 4- In no event shall SMC - Sangdest Microelectronics (Nanjing) Co., Ltd be liable for any failure in a semiconductor device or any secondary damage resulting from use at a value exceeding the absolute maximum rating.
- 5- No license is granted by the datasheet(s) under any patents or other rights of any third party or SMC - Sangdest Microelectronics (Nanjing) Co., Ltd.
- 6- The datasheet(s) may not be reproduced or duplicated, in any form, in whole or part, without the expressed written permission of SMC - Sangdest Microelectronics (Nanjing) Co., Ltd.
- 7- The products (technologies) described in the datasheet(s) are not to be provided to any party whose purpose in their application will hinder maintenance of international peace and safety nor are they to be applied to that purpose by their direct purchasers or any third party. When exporting these products (technologies), the necessary procedures are to be taken in accordance with related laws and regulations..