

XPT IGBT Module

3~ Rectifier	Brake Chopper	3~ Inverter
$V_{RRM} = 1600 \text{ V}$	$V_{CES} = 1200 \text{ V}$	$V_{CES} = 1200 \text{ V}$
$I_{DAV} = 290 \text{ A}$	$I_{C25} = 90 \text{ A}$	$I_{C25} = 120 \text{ A}$
$I_{FSM} = 1200 \text{ A}$	$V_{CE(sat)} = 1.8 \text{ V}$	$V_{CE(sat)} = 1.8 \text{ V}$

6-Pack + 3~ Rectifier Bridge & Brake Unit + NTC

Part number

MIXA81WB1200TEH

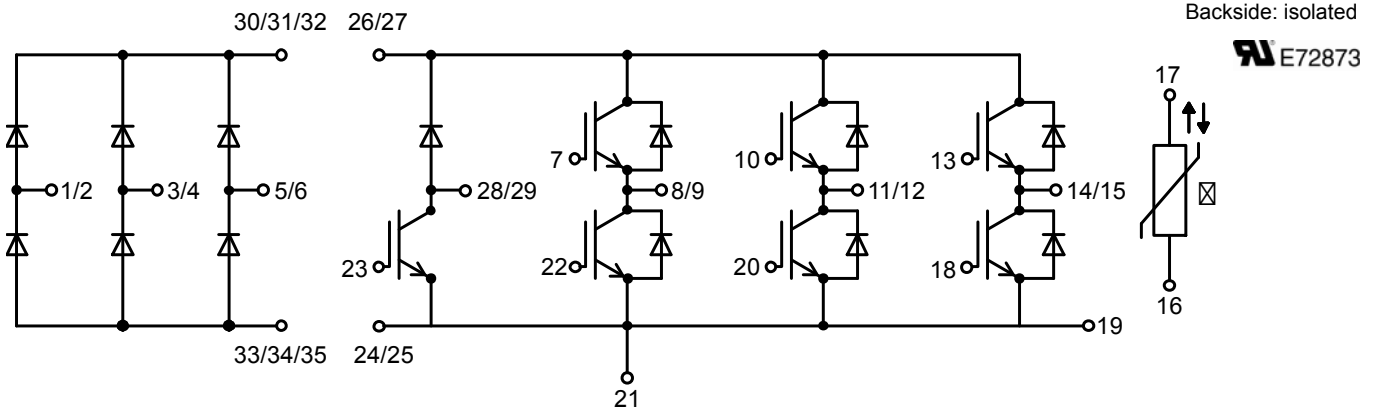
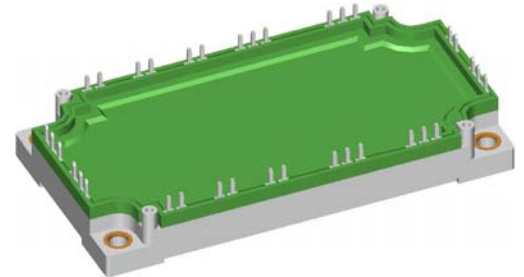

Features / Advantages:

- Easy paralleling due to the positive temperature coefficient of the on-state voltage
- Rugged XPT design (Xtreme light Punch Through) results in:
 - short circuit rated for 10 μsec .
 - very low gate charge
 - low EMI
 - square RBSOA @ 3x Ic
- Thin wafer technology combined with the XPT design results in a competitive low $V_{CE(sat)}$
- SONIC™ diode
 - fast and soft reverse recovery
 - low operating forward voltage

Applications:

- AC motor drives
- Solar inverter
- Medical equipment
- Uninterruptible power supply
- Air-conditioning systems
- Welding equipment
- Switched-mode and resonant-mode power supplies
- Inductive heating, cookers
- Pumps, Fans

Package: E3-Pack

- Isolation Voltage: 3600V~
- Industry standard outline
- RoHS compliant
- Soldering pins for PCB mounting
- Height: 17 mm
- Base plate: Copper internally DCB isolated
- Advanced power cycling

Rectifier				Ratings				
Symbol	Definition	Conditions		min.	typ.	max.	Unit	
V_{RSM}	max. non-repetitive reverse blocking voltage					1700	V	
V_{RRM}	max. repetitive reverse blocking voltage					1600	V	
I_R	reverse current, drain current	$V_R = 1600$ V	$T_{VJ} = 25^\circ\text{C}$			100	μA	
		$V_R = 1600$ V	$T_{VJ} = 125^\circ\text{C}$			0.5	mA	
V_F	forward voltage drop	$I_F = 120$ A	$T_{VJ} = 25^\circ\text{C}$			1.23	V	
							V	
		$I_F = 240$ A	$T_{VJ} = 125^\circ\text{C}$			1.19	V	
							V	
I_{DAV}	bridge output current	$T_C = 80^\circ\text{C}$ rectangular $d = \frac{1}{3}$	$T_{VJ} = 150^\circ\text{C}$			290	A	
V_{FO}	threshold voltage	} for power loss calculation only		$T_{VJ} = 150^\circ\text{C}$		0.85	V	
r_F	slope resistance					2.7	m Ω	
R_{thJC}	thermal resistance junction to case					0.45	K/W	
R_{thCH}	thermal resistance case to heatsink				0.10		K/W	
P_{tot}	total power dissipation			$T_C = 25^\circ\text{C}$		280	W	
I_{FSM}	max. forward surge current	$t = 10$ ms; (50 Hz), sine	$T_{VJ} = 45^\circ\text{C}$			1.20	kA	
						1.30	kA	
		$t = 8,3$ ms; (60 Hz), sine	$V_R = 0$ V	$T_{VJ} = 150^\circ\text{C}$			1.02	kA
							1.10	kA
I^2t	value for fusing	$t = 10$ ms; (50 Hz), sine	$T_{VJ} = 45^\circ\text{C}$			7.20	kA ² s	
						6.98	kA ² s	
		$t = 8,3$ ms; (60 Hz), sine	$V_R = 0$ V	$T_{VJ} = 150^\circ\text{C}$			5.20	kA ² s
							5.04	kA ² s
C_J	junction capacitance	$V_R = 600$ V $f = 1$ MHz	$T_{VJ} = 25^\circ\text{C}$		26		pF	

Brake IGBT				Ratings			
Symbol	Definition	Conditions	min.	typ.	max.	Unit	
V_{CES}	collector emitter voltage	$T_{VJ} = 25^{\circ}C$			1200	V	
V_{GES}	max. DC gate voltage				± 20	V	
V_{GEM}	max. transient collector gate voltage				± 30	V	
I_{C25}	collector current	$T_C = 25^{\circ}C$			90	A	
I_{C80}		$T_C = 80^{\circ}C$			60	A	
P_{tot}	total power dissipation	$T_C = 25^{\circ}C$			290	W	
$V_{CE(sat)}$	collector emitter saturation voltage	$I_C = 55\text{ A}; V_{GE} = 15\text{ V}$			1.8	V	
					2.1	V	
						V	
$V_{GE(th)}$	gate emitter threshold voltage	$I_C = 2\text{ mA}; V_{GE} = V_{CE}$	5.4	5.9	6.5	V	
I_{CES}	collector emitter leakage current	$V_{CE} = V_{CES}; V_{GE} = 0\text{ V}$			0.1	mA	
					0.1	mA	
						mA	
I_{GES}	gate emitter leakage current	$V_{GE} = \pm 20\text{ V}$			500	nA	
$Q_{G(on)}$	total gate charge	$V_{CE} = 600\text{ V}; V_{GE} = 15\text{ V}; I_C = 55\text{ A}$			165	nC	
$t_{d(on)}$	turn-on delay time	inductive load $V_{CE} = 600\text{ V}; I_C = 55\text{ A}$ $V_{GE} = \pm 15\text{ V}; R_G = 15\ \Omega$			70	ns	
t_r	current rise time				40	ns	
$t_{d(off)}$	turn-off delay time				250	ns	
t_f	current fall time				100	ns	
E_{on}	turn-on energy per pulse				4.5	mJ	
E_{off}	turn-off energy per pulse				5.5	mJ	
R_{BSOA}	reverse bias safe operating area	$V_{GE} = \pm 15\text{ V}; R_G = 15\ \Omega$					
I_{CM}		$V_{CEK} = 1200\text{ V}$			150	A	
R_{SCSOA}	short circuit safe operating area						
t_{SC}	short circuit duration	$V_{CE} = 900\text{ V}; V_{GE} = \pm 15\text{ V}$			10	μs	
I_{SC}	short circuit current	$R_G = 15\ \Omega$; non-repetitive			200	A	
R_{thJC}	thermal resistance junction to case				0.43	K/W	
R_{thCH}	thermal resistance case to heatsink				0.10	K/W	
Brake Diode							
V_{RRM}	max. repetitive reverse voltage	$T_{VJ} = 25^{\circ}C$			1200	V	
I_{F25}	forward current	$T_C = 25^{\circ}C$			44	A	
I_{F80}		$T_C = 80^{\circ}C$			29	A	
V_F	forward voltage	$I_F = 30\text{ A}$			2.20	V	
					1.90	V	
I_R	reverse current	$V_R = V_{RRM}$			0.1	mA	
					2	mA	
Q_{rr}	reverse recovery charge	$V_R = 600\text{ V}$ $-di_F/dt = 600\text{ A}/\mu s$ $I_F = 30\text{ A}$			3.5	μC	
I_{RM}	max. reverse recovery current				30	A	
t_{rr}	reverse recovery time				350	ns	
E_{rec}	reverse recovery energy				0.9	mJ	
R_{thJC}	thermal resistance junction to case				1.2	K/W	
R_{thCH}	thermal resistance case to heatsink				0.10	K/W	

Inverter IGBT			Ratings			
Symbol	Definition	Conditions	min.	typ.	max.	Unit
V_{CES}	collector emitter voltage	$T_{VJ} = 25^{\circ}\text{C}$			1200	V
V_{GES}	max. DC gate voltage				± 20	V
V_{GEM}	max. transient collector gate voltage				± 30	V
I_{C25}	collector current	$T_C = 25^{\circ}\text{C}$			120	A
I_{C80}		$T_C = 80^{\circ}\text{C}$			84	A
P_{tot}	total power dissipation	$T_C = 25^{\circ}\text{C}$			390	W
$V_{CE(sat)}$	collector emitter saturation voltage	$I_C = 75\text{ A}; V_{GE} = 15\text{ V}$			1.8	V
					2.1	V
$V_{GE(th)}$	gate emitter threshold voltage	$I_C = 3\text{ mA}; V_{CE} = V_{CE}$	5.4	5.9	6.5	V
I_{CES}	collector emitter leakage current	$V_{CE} = V_{CES}; V_{GE} = 0\text{ V}$			0.2	mA
					0.6	mA
I_{GES}	gate emitter leakage current	$V_{GE} = \pm 20\text{ V}$			500	nA
$Q_{G(on)}$	total gate charge	$V_{CE} = 600\text{ V}; V_{GE} = 15\text{ V}; I_C = 75\text{ A}$		230		nC
$t_{d(on)}$	turn-on delay time	inductive load $V_{CE} = 600\text{ V}; I_C = 75\text{ A}$ $V_{GE} = \pm 15\text{ V}; R_G = 10\ \Omega$		70		ns
t_r	current rise time			40		ns
$t_{d(off)}$	turn-off delay time			250		ns
t_f	current fall time			100		ns
E_{on}	turn-on energy per pulse			6.8		mJ
E_{off}	turn-off energy per pulse			8.3		mJ
$RBSOA$	reverse bias safe operating area	$V_{GE} = \pm 15\text{ V}; R_G = 10\ \Omega$				
I_{CM}		$V_{CEmax} = 1200\text{ V}$			225	A
$SCSOA$	short circuit safe operating area	$V_{CEmax} = 1200\text{ V}$				
t_{sc}	short circuit duration	$V_{CE} = 900\text{ V}; V_{GE} = \pm 15\text{ V}$			10	μs
I_{sc}	short circuit current	$R_G = 10\ \Omega; \text{non-repetitive}$		300		A
R_{thJC}	thermal resistance junction to case				0.32	K/W
R_{thCH}	thermal resistance case to heatsink			0.10		K/W
Inverter Diode						
V_{RRM}	max. repetitive reverse voltage	$T_{VJ} = 25^{\circ}\text{C}$			1200	V
I_{F25}	forward current	$T_C = 25^{\circ}\text{C}$			135	A
I_{F80}		$T_C = 80^{\circ}\text{C}$			90	A
V_F	forward voltage	$I_F = 100\text{ A}$			2.20	V
				1.90		V
I_R	reverse current	$V_R = V_{RRM}$			*	mA
	* not applicable, see Ices value above				*	mA
Q_{rr}	reverse recovery charge	$V_R = 600\text{ V}$ $-di_F/dt = 1600\text{ A}/\mu\text{s}$ $I_F = 100\text{ A}; V_{GE} = 0\text{ V}$		12.5		μC
I_{RM}	max. reverse recovery current			100		A
t_{rr}	reverse recovery time			350		ns
E_{rec}	reverse recovery energy			4		mJ
R_{thJC}	thermal resistance junction to case				0.4	K/W
R_{thCH}	thermal resistance case to heatsink			0.10		K/W

Package E3-Pack			Ratings			
Symbol	Definition	Conditions	min.	typ.	max.	Unit
I_{RMS}	RMS current	per terminal			300	A
T_{stg}	storage temperature		-40		125	°C
T_{VJ}	virtual junction temperature		-40		150	°C
Weight				270		g
M_D	mounting torque		3		6	Nm
V_{ISOL}	isolation voltage	t = 1 second	3600			V
		t = 1 minute	3000			V
$d_{Spp/App}$	creepage distance on surface striking distance through air	terminal to terminal	6.0			mm
$d_{Spb/Apb}$		terminal to backside	12.0			mm
$R_{pin-chip}$	resistance pin to chip			5		mΩ

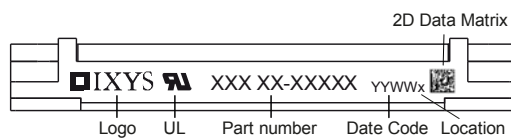

Part number

- M = Module
- I = IGBT
- X = XPT IGBT
- A = Gen 1 / std
- 81 = Current Rating [A]
- WB = 6-Pack + 3~ Rectifier Bridge & Brake Unit
- 1200 = Reverse Voltage [V]
- T = Thermistor \ Temperature sensor
- EH = E3-Pack

Ordering	Part Number	Marking on Product	Delivery Mode	Quantity	Code No.
Standard	MIXA81WB1200TEH	MIXA81WB1200TEH	Box	5	512760

Temperature Sensor NTC

Symbol	Definition	Conditions	min.	typ.	max.	Unit
R_{25}	resistance	$T_{VJ} = 25^\circ$	4.75	5	5.25	kΩ
$B_{25/50}$	temperature coefficient			3375		K

Equivalent Circuits for Simulation

* on die level

$T_{VJ} = 150^\circ\text{C}$

		Rectifier	Brake IGBT	Brake Diode	Inverter IGBT	Inverter Diode	
V_0	threshold voltage	0.85	1.1	1.2	1.1	1.35	V
R_0	slope resistance *	2.7	25	27	17.9	8.5	mΩ

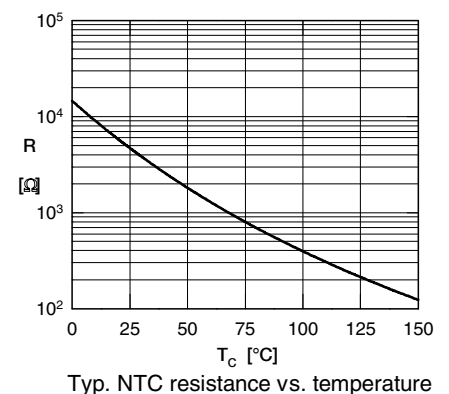

Outlines E3-Pack

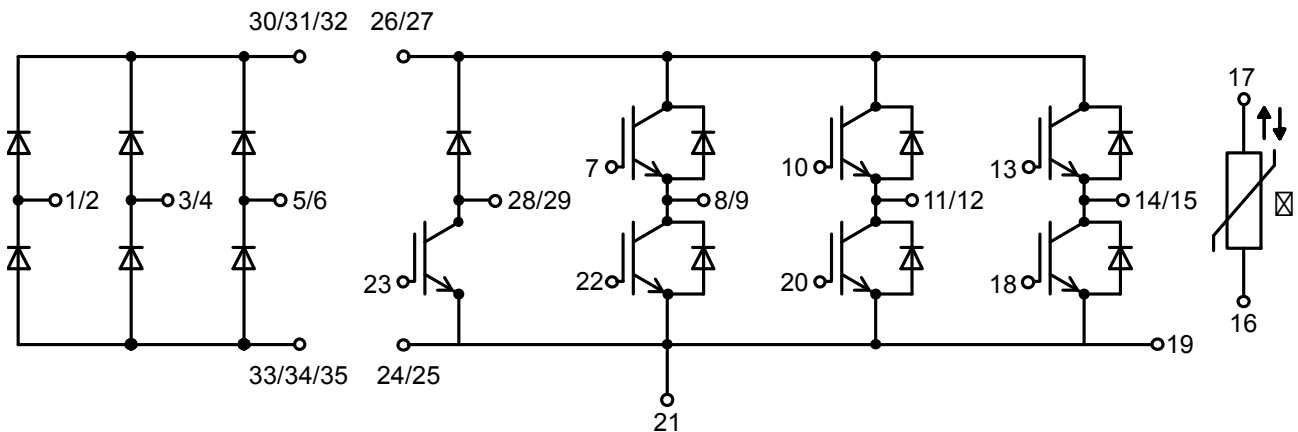
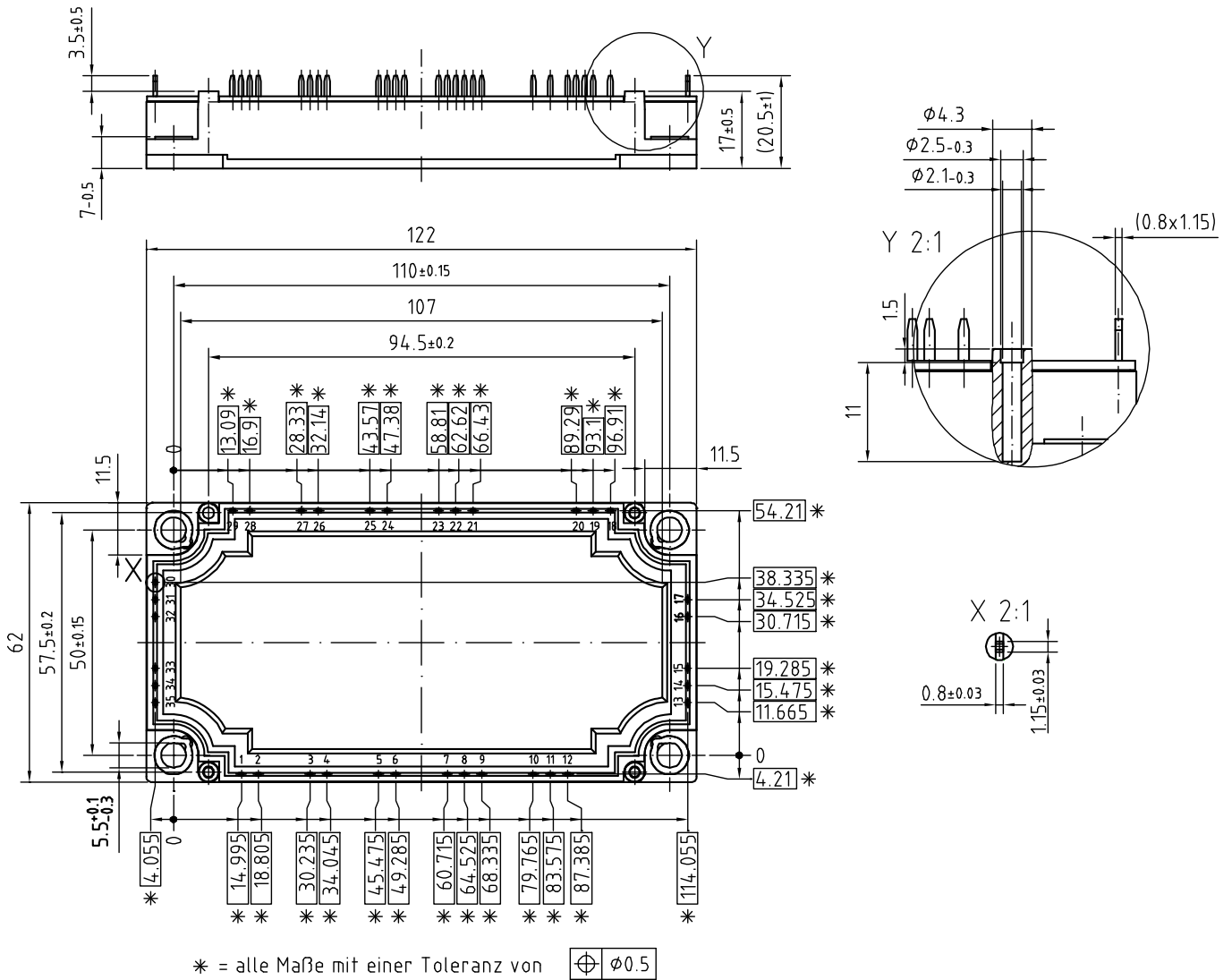

Rectifier

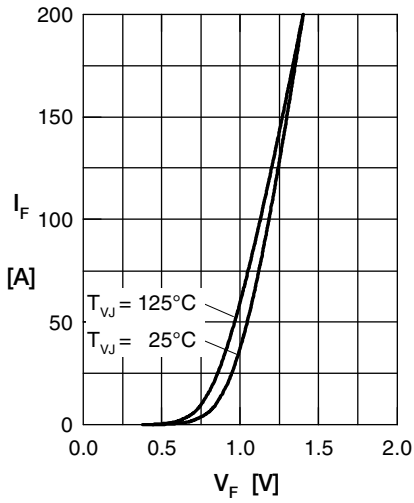

Fig. 1 Forward current versus voltage drop per diode

Fig. 2 Surge overload current

Fig. 3 I^2t versus time per diode

Fig. 4 Power dissipation versus direct output current and ambient temperature, sine 180°

Fig. 5 Max. forward current versus case temperature

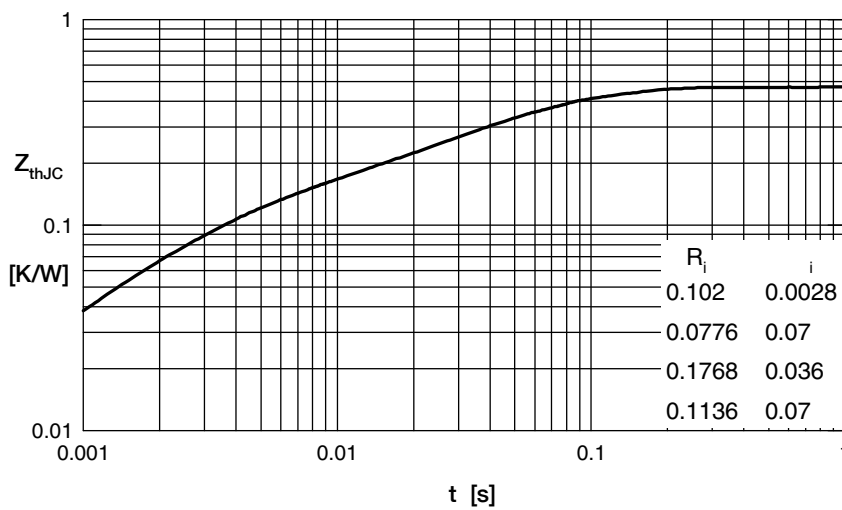

Fig. 6 Transient thermal impedance junction to case

Brake IGBT

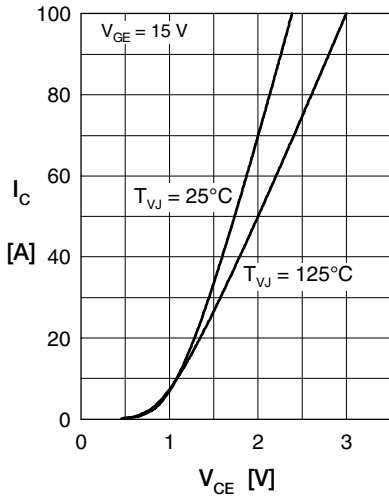

Fig. 1 Typ. output characteristics

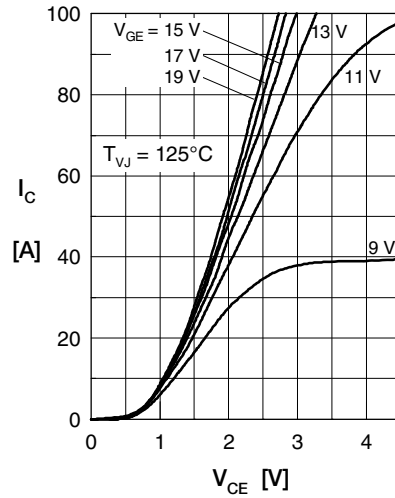

Fig. 2 Typ. output characteristics

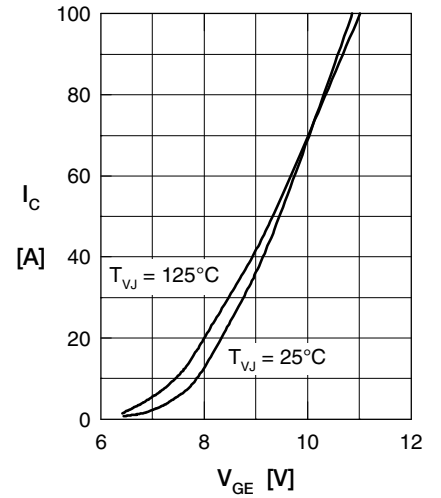

Fig. 3 Typ. transfer characteristics

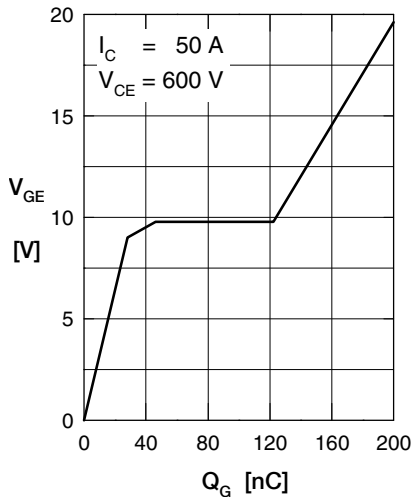

Fig. 4 Typ. turn-on gate charge

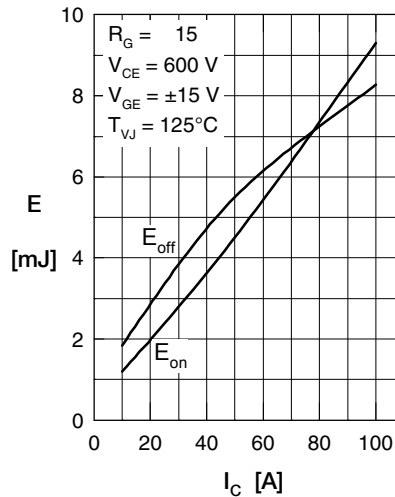

Fig. 5 Typ. switching energy versus collector current

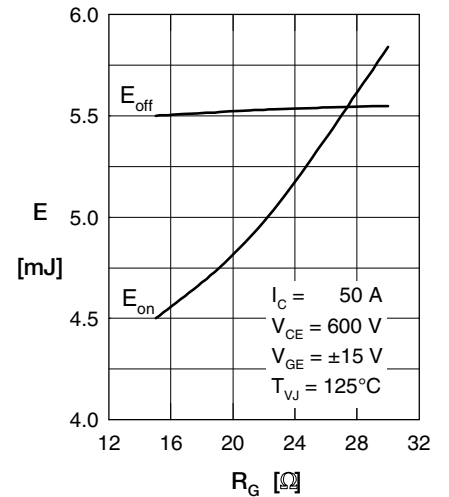

Fig. 6 Typ. switching energy versus gate resistance

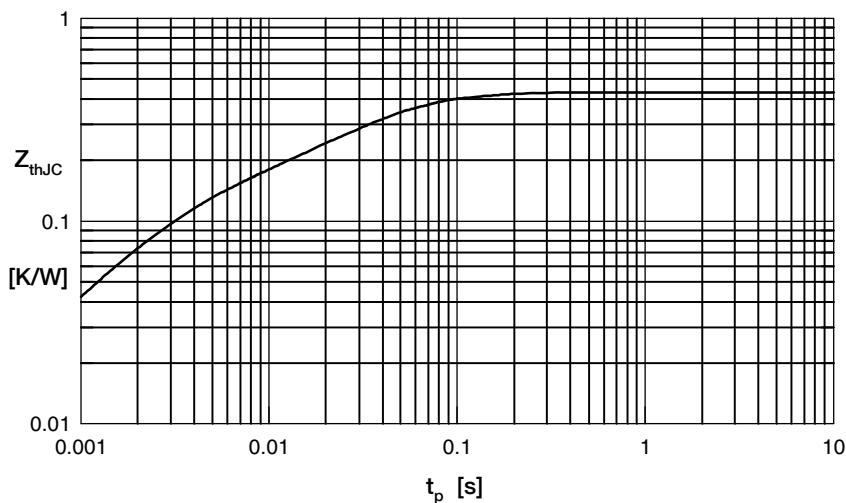

Fig. 7 Typ. transient thermal impedance

Brake Diode

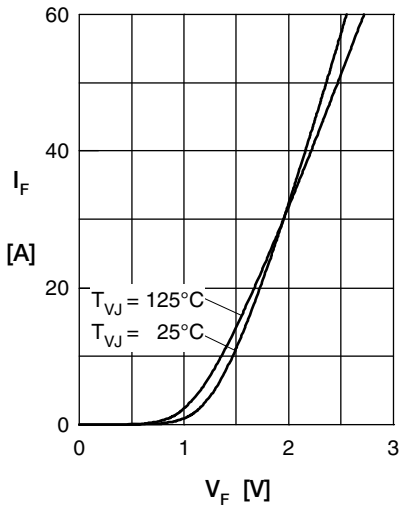

Fig. 1 Typ. Forward current I_F versus V_F

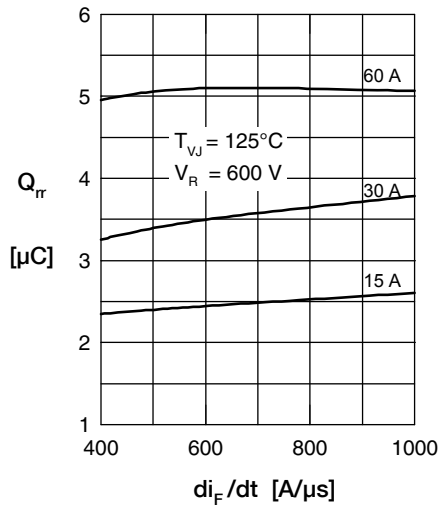

Fig. 2 Typ. reverse recov. charge Q_{rr} versus di/dt

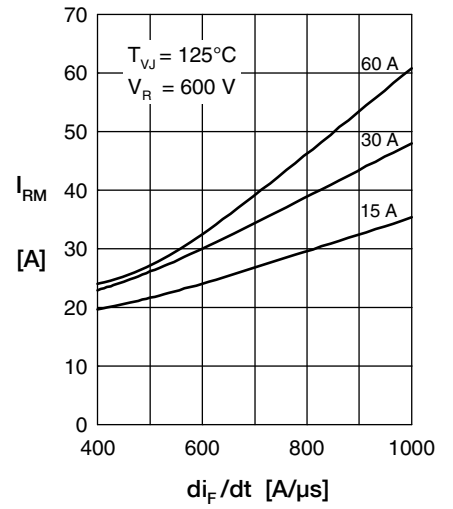

Fig. 3 Typ. peak reverse current I_{RM} versus di/dt

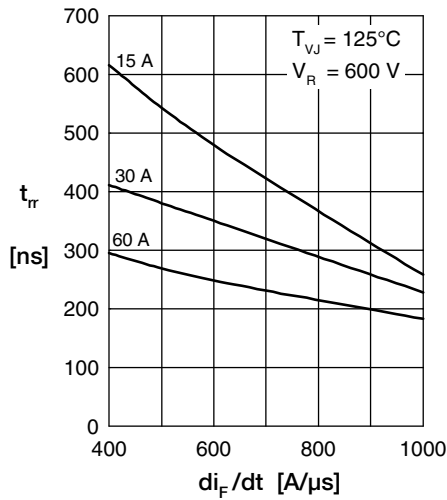

Fig. 4 Dynamic parameters Q_r , I_{RM} versus T_{VJ}

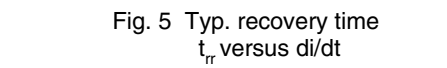

Fig. 5 Typ. recovery time t_{rr} versus di/dt

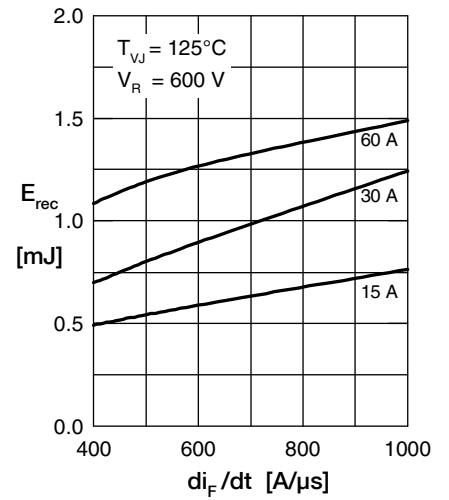

Fig. 6 Typ. recovery energy E_{rec} versus di/dt

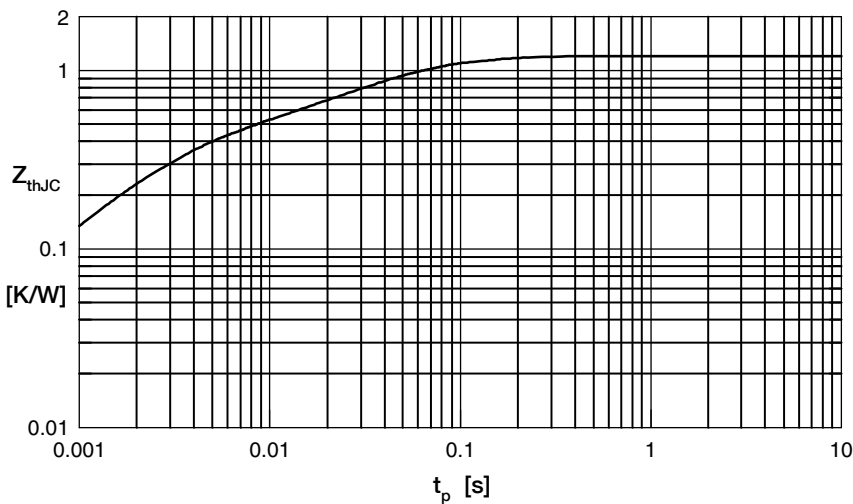

Fig. 7 Typ. transient thermal impedance

Inverter IGBT

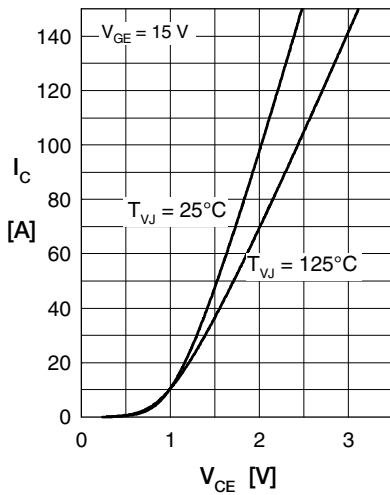

Fig. 1 Typ. output characteristics

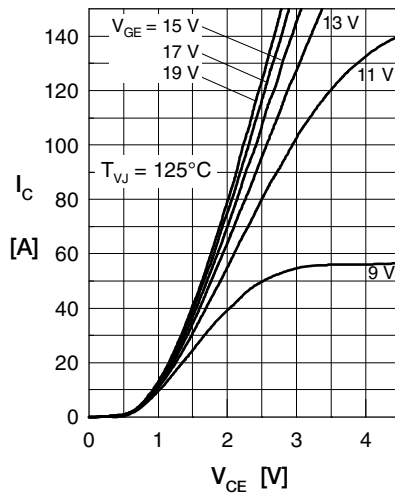

Fig. 2 Typ. output characteristics

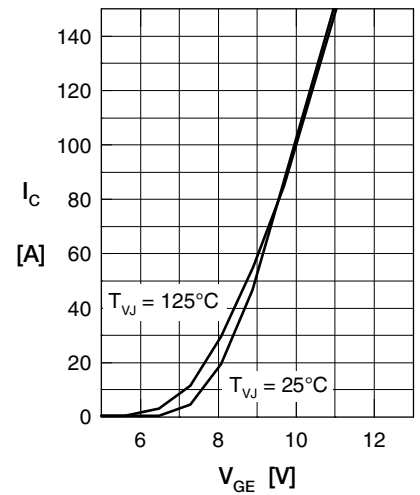

Fig. 3 Typ. transfer characteristics

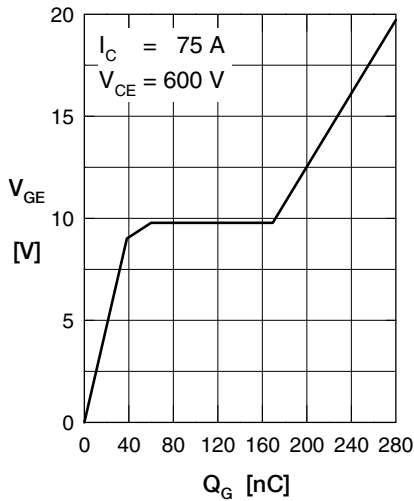

Fig. 4 Typ. turn-on gate charge

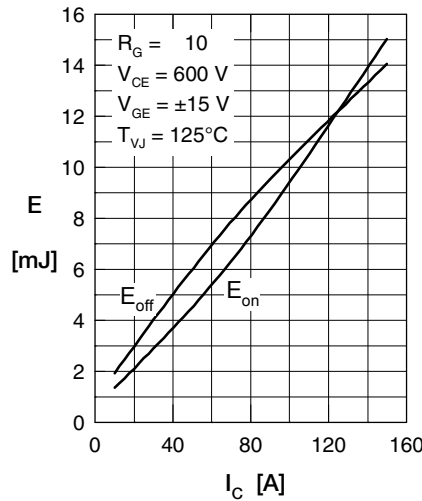

Fig. 5 Typ. switching energy versus collector current

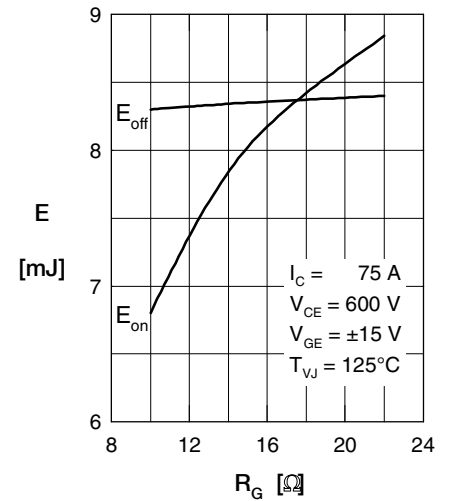

Fig. 6 Typ. switching energy versus gate resistance

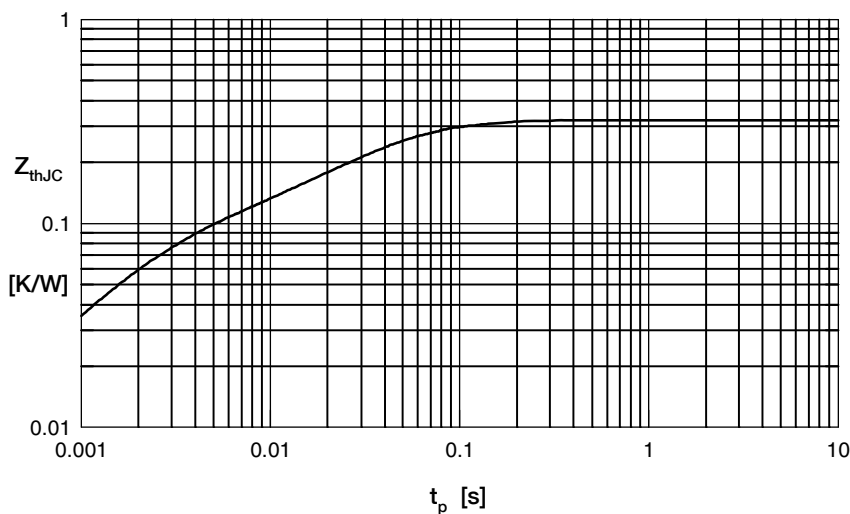

Fig. 7 Typ. transient thermal impedance

Inverter Diode

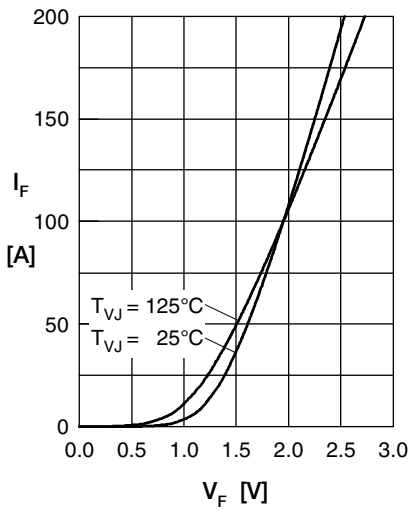

Fig. 1 Typ. Forward current I_F versus V_F

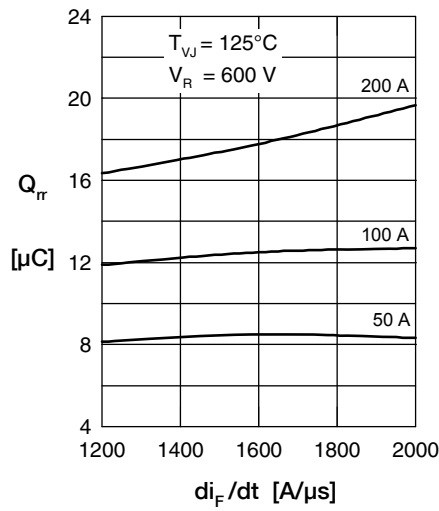

Fig. 2 Typ. reverse recov. charge Q_{rr} versus di_F/dt

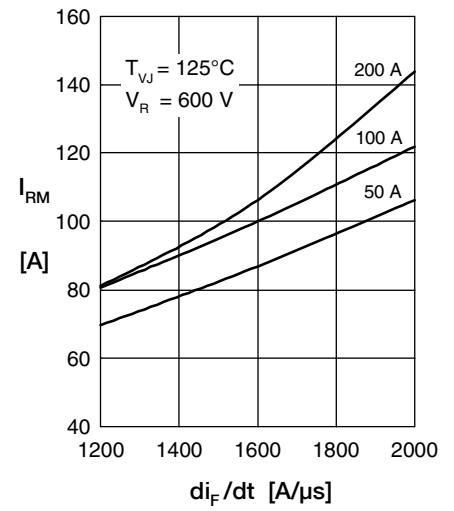

Fig. 3 Typ. peak reverse current I_{RM} versus di_F/dt

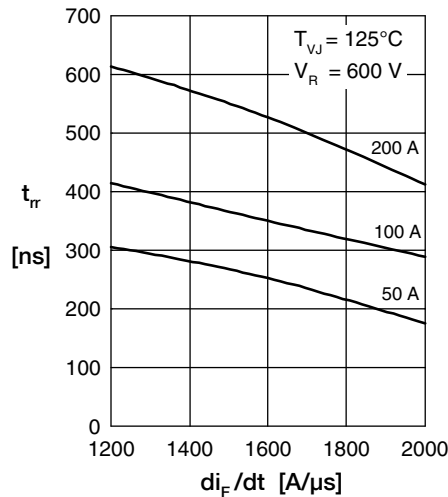

Fig. 4 Dynamic parameters Q_r, I_{RM} versus T_{VJ}

Fig. 5 Typ. recovery time t_{rr} versus di_F/dt

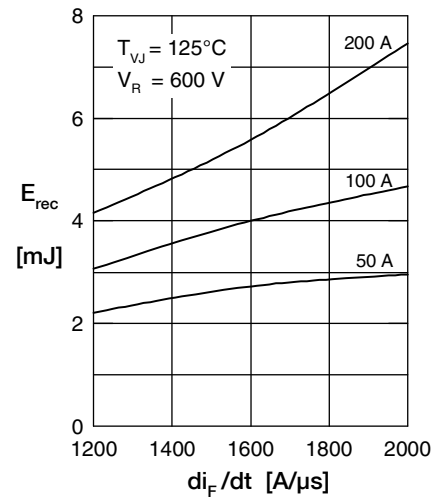

Fig. 6 Typ. recovery energy E_{rec} versus di_F/dt

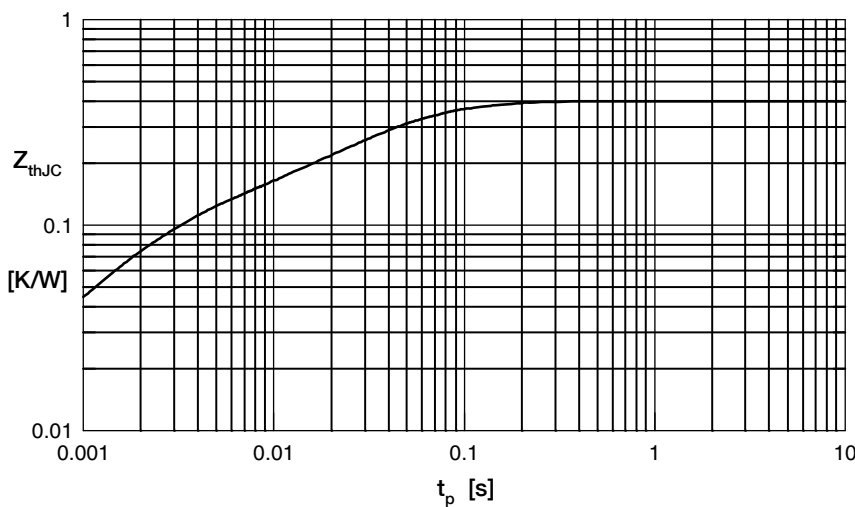

Fig. 7 Typ. transient thermal impedance