

Automotive-grade N-channel 60 V, 2.3 mΩ typ., 180 A STripFET™ F6 Power MOSFET in a TO-220 package

Datasheet - production data

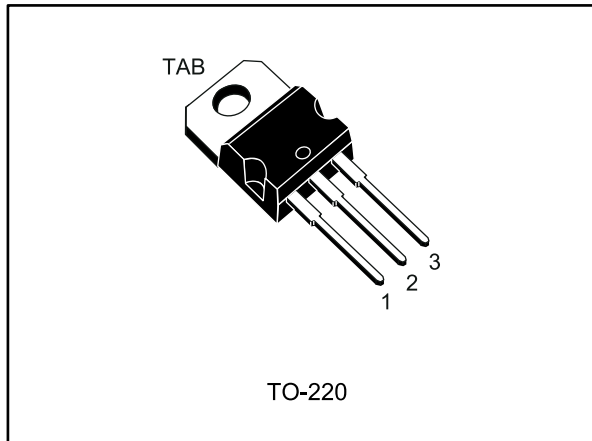

Figure 1: Internal schematic diagram

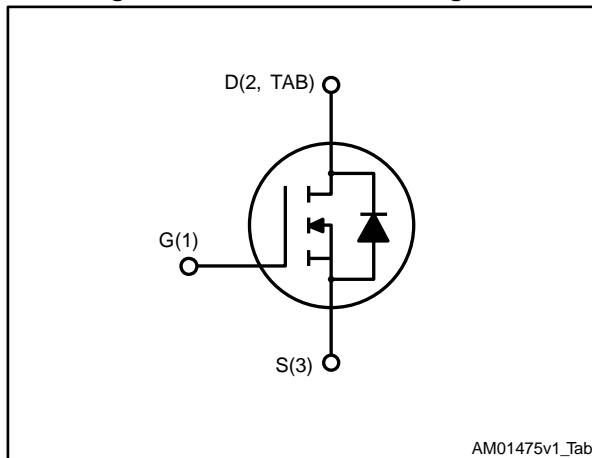

Table 1: Device summary

Order code	Marking	Package	Packing
STP265N6F6AG	265N6F6	TO-220	Tube

Features

Order code	V _{DS}	R _{DS(on)} max	I _D
STP265N6F6AG	60 V	2.85 mΩ	180 A

- AEC-Q101 qualified
- Very low on-resistance
- Very low gate charge
- High avalanche ruggedness
- Low gate drive power loss



Applications

- Switching applications

Description

This device is an N-channel Power MOSFET developed using the STripFET™ F6 technology with a new trench gate structure. The resulting Power MOSFET exhibits very low R_{DS(on)} in all packages.

Contents

1	Electrical ratings	3
2	Electrical characteristics	4
	2.1 Electrical characteristics (curves)	6
3	Test circuits	8
4	Package information	9
	4.1 TO-220 mechanical data	10
5	Revision history	12

1 Electrical ratings

Table 2: Absolute maximum ratings

Symbol	Parameter	Value	Unit
V_{DS}	Drain-source voltage	60	V
V_{GS}	Gate-source voltage	± 20	V
$I_D^{(1)}$	Drain current (continuous) at $T_C = 25\text{ }^\circ\text{C}$	180	A
$I_D^{(1)}$	Drain current (continuous) at $T_C = 100\text{ }^\circ\text{C}$	180	A
$I_{DM}^{(2)}$	Drain current (pulsed)	720	A
P_{TOT}	Total dissipation at $T_C = 25\text{ }^\circ\text{C}$	300	W
E_{AS}	Single pulse avalanche energy (Starting $T_J = 25\text{ }^\circ\text{C}$, $I_D = 80\text{ A}$)	720	mJ
T_{stg}	Storage temperature range	- 55 to 175	$^\circ\text{C}$
T_j	Operating junction temperature range		

Notes:

(1) Current limited by package.

(2) Pulse width limited by safe operating area.

Table 3: Thermal data

Symbol	Parameter	Value	Unit
$R_{thj-case}$	Thermal resistance junction-case max	0.5	$^\circ\text{C}/\text{W}$
$R_{thj-amb}$	Thermal resistance junction-amb max	62.5	$^\circ\text{C}/\text{W}$

2 Electrical characteristics

(T_{CASE} = 25 °C unless otherwise specified)

Table 4: On/off states

Symbol	Parameter	Test conditions	Min.	Typ.	Max.	Unit
V _{(BR)DSS}	Drain-source breakdown voltage	I _D = 250 μA, V _{GS} = 0 V	60			V
I _{DSS}	Zero gate voltage drain current	V _{DS} = 60 V, V _{GS} = 0 V			1	μA
		V _{DS} = 60 V, T _C = 125 °C ⁽¹⁾ V _{GS} = 0 V			100	μA
I _{GSS}	Gate-body leakage current	V _{GS} = ± 20 V, V _{DS} = 0 V			± 100	nA
V _{GS(th)}	Gate threshold voltage	V _{DS} = V _{GS} , I _D = 250 μA	2		4	V
R _{DS(on)}	Static drain-source on-resistance	V _{GS} = 10 V, I _D = 60 A		2.3	2.85	mΩ

Notes:

⁽¹⁾Defined by design, not subject to production test.

Table 5: Dynamic

Symbol	Parameter	Test conditions	Min.	Typ.	Max.	Unit
C _{iss}	Input capacitance	V _{DS} = 25 V, f = 1 MHz, V _{GS} = 0 V	-	11800	-	pF
C _{oss}	Output capacitance		-	1235	-	pF
C _{rss}	Reverse transfer capacitance		-	488	-	pF
Q _g	Total gate charge	V _{DD} = 30 V, I _D = 120 A, V _{GS} = 10 V (see Figure 14: "Test circuit for gate charge behavior")	-	183	-	nC
Q _{gs}	Gate-source charge		-	53	-	nC
Q _{gd}	Gate-drain charge		-	41	-	nC

Table 6: Switching times

Symbol	Parameter	Test conditions	Min.	Typ.	Max.	Unit
t _{d(on)}	Turn-on delay time	V _{DD} = 30 V, I _D = 60 A, R _G = 4.7 Ω, V _{GS} = 10 V (see Figure 13: "Test circuit for resistive load switching times" and Figure 18: "Switching time waveform")	-	31	-	ns
t _r	Rise time		-	165	-	ns
t _{d(off)}	Turn-off-delay time		-	144	-	ns
t _f	Fall time		-	63	-	ns

Table 7: Source drain diode

Symbol	Parameter	Test conditions	Min.	Typ.	Max.	Unit
I_{SD}	Source-drain current				180	A
$I_{SDM}^{(1)}$	Source-drain current (pulsed)				720	A
$V_{SD}^{(2)}$	Forward on voltage	$I_{SD} = 180 \text{ A}$, $V_{GS} = 0 \text{ V}$			1.1	V
t_{rr}	Reverse recovery time	$I_{SD} = 120 \text{ A}$, $V_{DD} = 48 \text{ V}$ $di/dt = 100 \text{ A}/\mu\text{s}$, $T_j = 150 \text{ }^\circ\text{C}$ (see Figure 15: "Test circuit for inductive load switching and diode recovery times")	-	56	-	ns
Q_{rr}	Reverse recovery charge		-	116	-	nC
I_{RRM}	Reverse recovery current		-	3.8	-	A

Notes:

(1) Pulse width limited by safe operating area.

(2) Pulsed: pulse duration = 300 μs , duty cycle 1.5%

2.1 Electrical characteristics (curves)

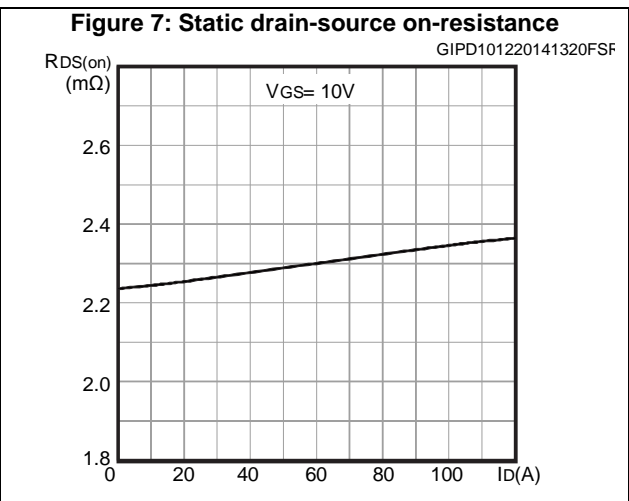
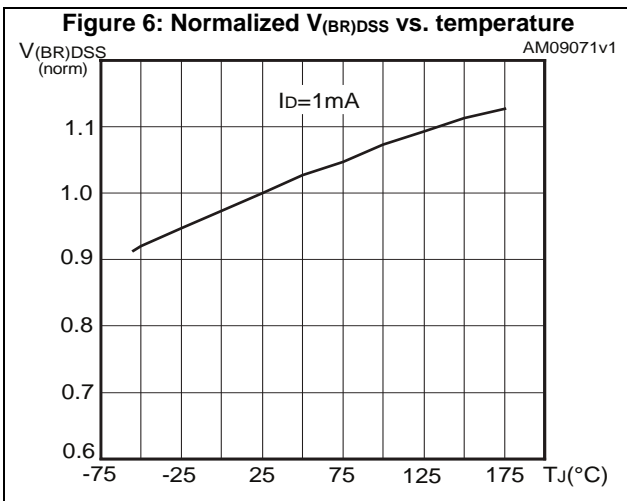
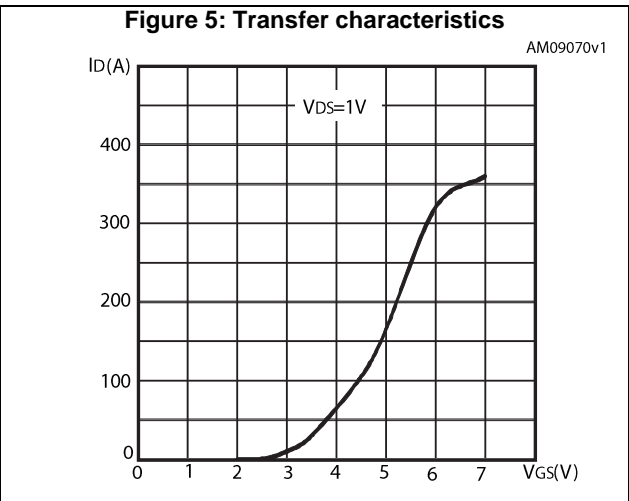
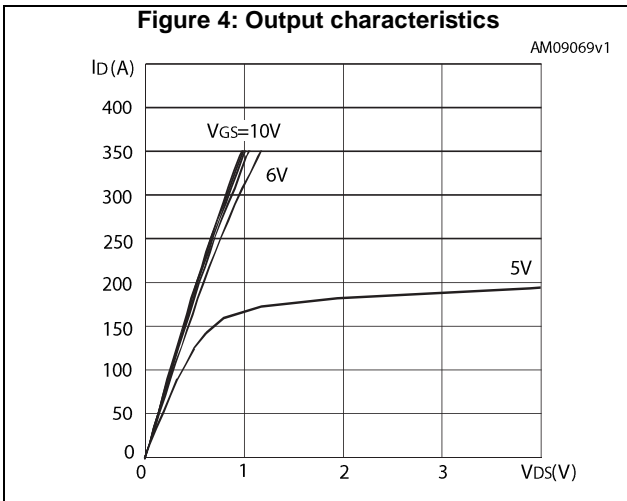
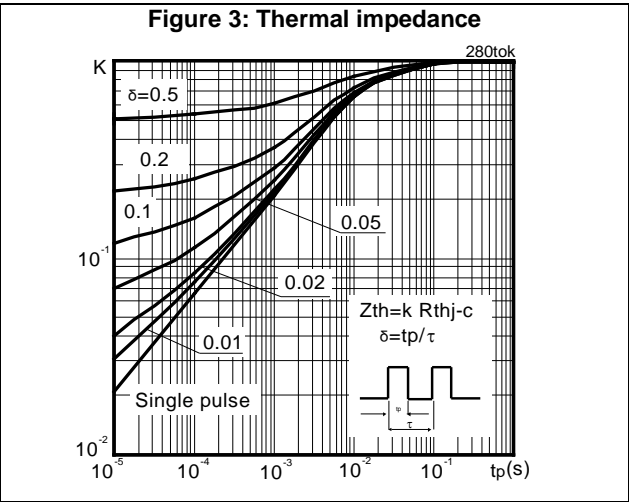
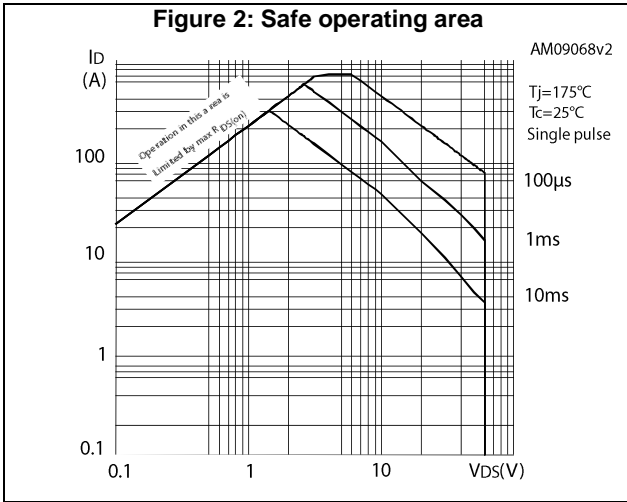

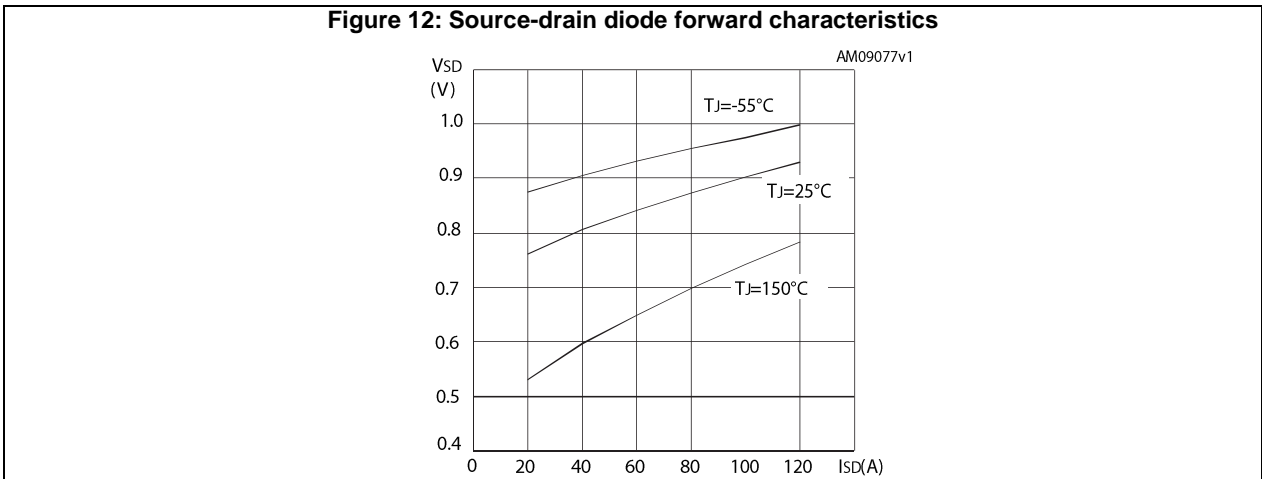
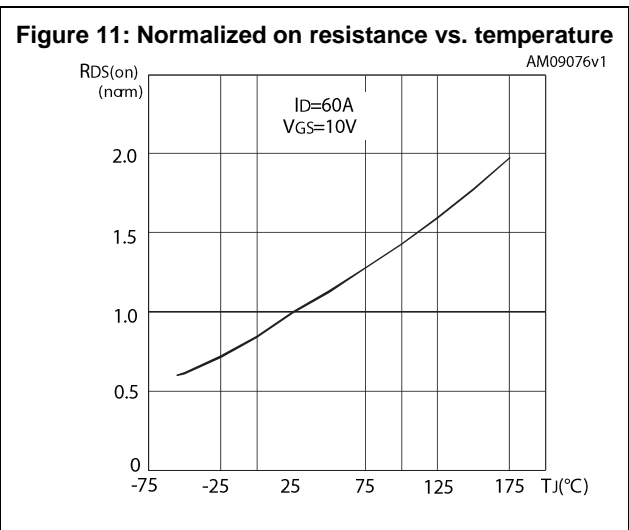
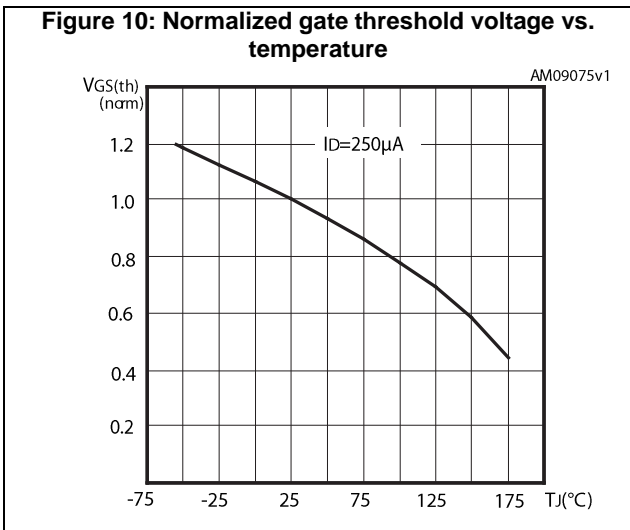
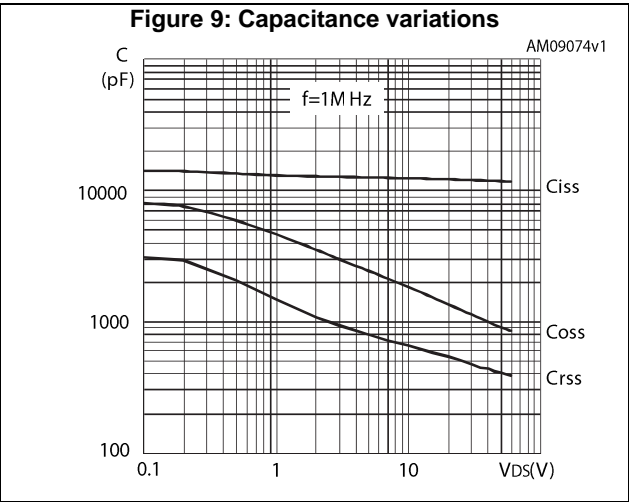
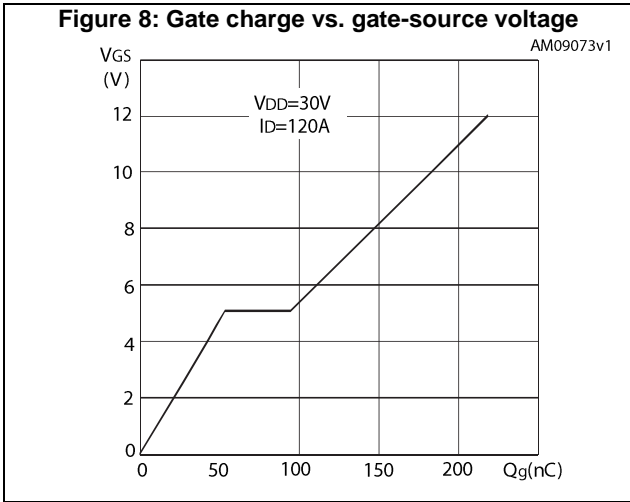

3 Test circuits

Figure 13: Test circuit for resistive load switching times

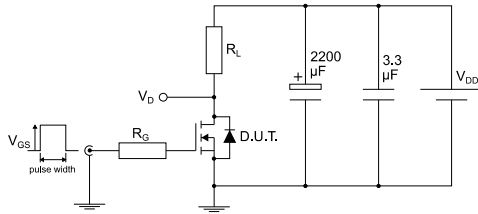

AM01468v1

Figure 14: Test circuit for gate charge behavior

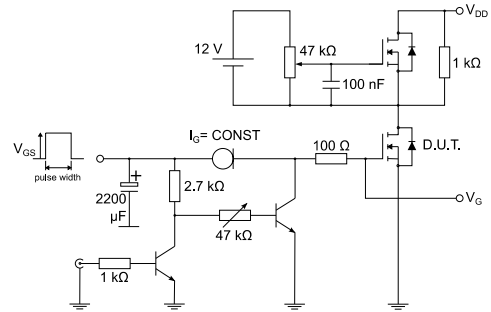

AM01469v1

Figure 15: Test circuit for inductive load switching and diode recovery times

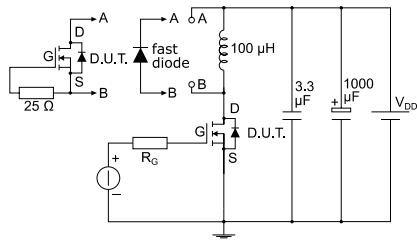

AM01470v1

Figure 16: Unclamped inductive load test circuit

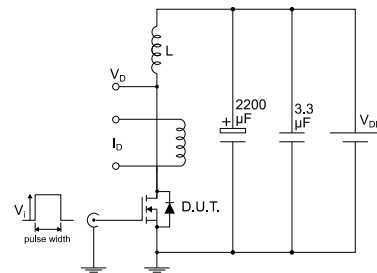

AM01471v1

Figure 17: Unclamped inductive waveform

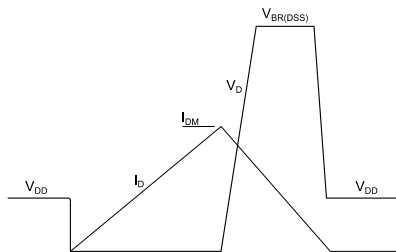

AM01472v1

Figure 18: Switching time waveform

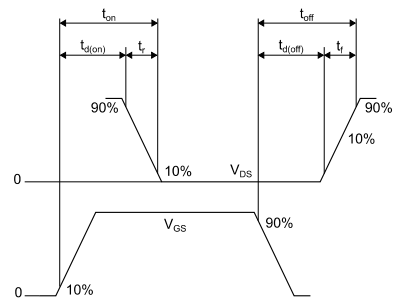

AM01473v1

4 Package information

In order to meet environmental requirements, ST offers these devices in different grades of ECOPACK® packages, depending on their level of environmental compliance. ECOPACK® specifications, grade definitions and product status are available at: www.st.com. ECOPACK® is an ST trademark.

4.1 TO-220 mechanical data

Figure 19: TO-220 type A package outline

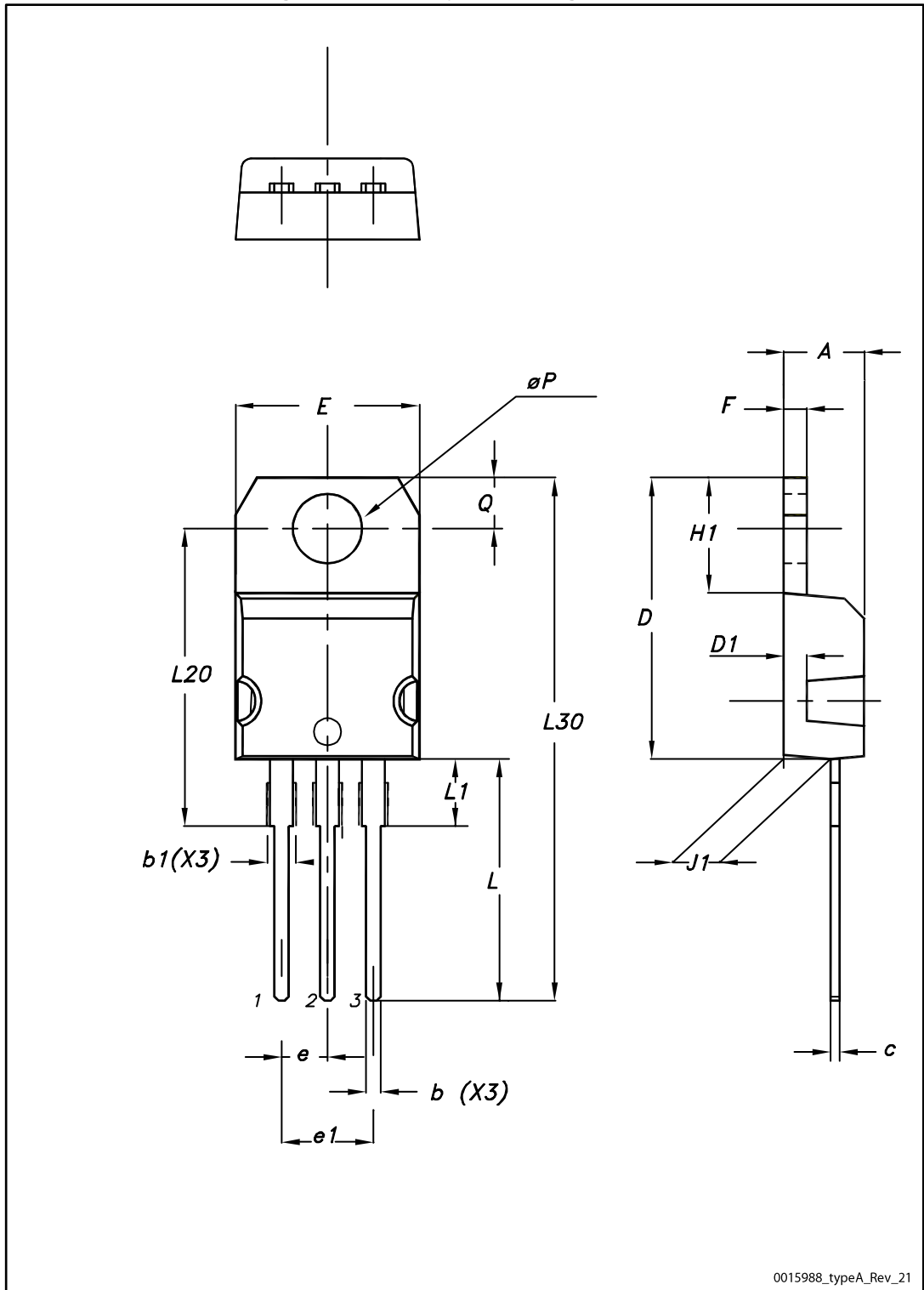

Table 8: TO-220 type A mechanical data

Dim.	mm		
	Min.	Typ.	Max.
A	4.40		4.60
b	0.61		0.88
b1	1.14		1.55
c	0.48		0.70
D	15.25		15.75
D1		1.27	
E	10.00		10.40
e	2.40		2.70
e1	4.95		5.15
F	1.23		1.32
H1	6.20		6.60
J1	2.40		2.72
L	13.00		14.00
L1	3.50		3.93
L20		16.40	
L30		28.90	
øP	3.75		3.85
Q	2.65		2.95

5 Revision history

Table 9: Document revision history

Date	Revision	Changes
10-Dec-2014	1	First release.
16-Dec-2014	2	Document status promoted from preliminary to production data.
16-Nov-2016	3	The part number STW265N6F6AG has been moved to a separate datasheet. Updated title, cover image, features and description in cover page. Updated Table 1: "Device summary" , Table 3: "Thermal data" , Section 4: "Package information" . Minor text changes.

IMPORTANT NOTICE – PLEASE READ CAREFULLY

STMicroelectronics NV and its subsidiaries ("ST") reserve the right to make changes, corrections, enhancements, modifications, and improvements to ST products and/or to this document at any time without notice. Purchasers should obtain the latest relevant information on ST products before placing orders. ST products are sold pursuant to ST's terms and conditions of sale in place at the time of order acknowledgement.

Purchasers are solely responsible for the choice, selection, and use of ST products and ST assumes no liability for application assistance or the design of Purchasers' products.

No license, express or implied, to any intellectual property right is granted by ST herein.

Resale of ST products with provisions different from the information set forth herein shall void any warranty granted by ST for such product.

ST and the ST logo are trademarks of ST. All other product or service names are the property of their respective owners.

Information in this document supersedes and replaces information previously supplied in any prior versions of this document.

© 2016 STMicroelectronics – All rights reserved